

RADIO — ELECTRONICS

formerly

**RADIO
CRAFT**

IN THIS ISSUE
Eight-Tube Televiser
Survey of Multitesters

HUGO GERNSBACK,
Editor

**FIRST NON-PRO
EXPERIMENTAL
TV RELAY
STATION**
SEE TELEVISION SECTION

1949 RADIO PARTS SHOW
MAY 17 — 20
HOTEL STEVENS, CHICAGO



MAY
1949

30¢

U. S. and
CANADA

LATEST IN RADIO — ELECTRONICS — TELEVISION



"Madame X" was the code name, during research and development, for an entirely new system of recorded music . . . perfected by RCA.

The remarkable background of "Madame X"

Now the identity of "Madame X," the *unknown* in a long search for tone perfection, has been revealed. From this quest emerges a completely integrated record-playing *system*—records and automatic player—the first to be entirely free of distortion to the trained musical ear . . .

The research began 11 years ago at RCA Laboratories. First, basic factors were determined—minimum diameters, at different speeds, of the groove spiral in the record—beyond which distortion would occur; size of stylus to be used;

desired length of playing time. From these came the mathematical answer to the record's *speed*—45 turns a minute—and to the record's size, only 6 $\frac{3}{8}$ inches in diameter.

With this speed and size, engineers could guarantee 5 $\frac{1}{2}$ minutes of distortion-free performance, and the finest quality record in RCA Victor history!

The record itself is non-breakable vinyl plastic, wafer-thin. *Yet it plays as long as a conventional 12-inch record.* The new RCA Victor automatic record changer accommodates up to 10 of the new records—1 hour and 40 minutes of

playing time—and can be attached to almost any radio, phonograph, or television combination.

Not only records are free of surface noise and distortion—the record player eliminates faulty operation, noise, and cumbersome size. Records are changed quickly, quietly . . . RCA Victor will continue to supply 78 rpm instruments and records.

This far-reaching advance is one of hundreds which have grown from RCA research. Such leadership adds *value beyond price* to any product or service of RCA and RCA Victor.



RADIO CORPORATION of AMERICA

World Leader in Radio — First in Television

LEARN RADIO

BY PRACTICING IN SPARE TIME

As part of my Course I send you the speaker, tubes, chassis, transformer, loop antenna, etc., to build this modern, powerful Radio Receiver! In addition, I send you parts to build many other real Radio circuits, like the Signal Generator, Radio Tester and Superheterodyne Receiver pictured below. You use this material to get practical radio experience and to make EXTRA money fixing neighbors' Radios in spare time. Mail coupon below for complete information!

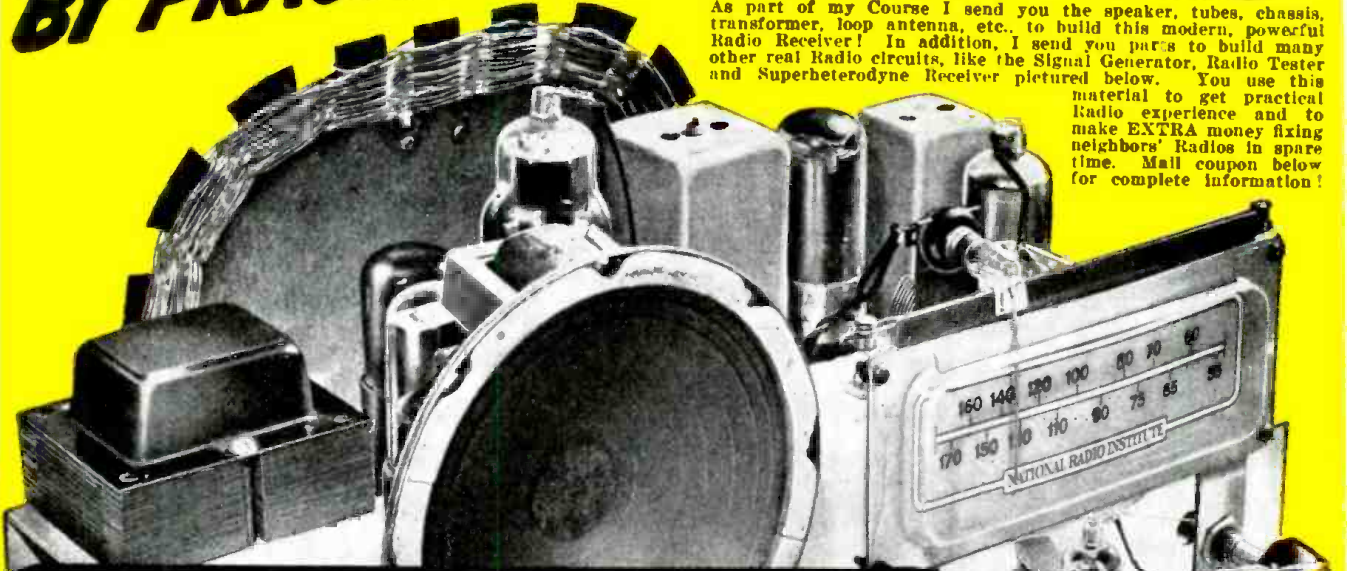

I SEND YOU BIG KITS OF PARTS
You Build and Experiment
With this MODERN RADIO
AND MANY OTHER CIRCUITS



J. E. SMITH, President
National Radio Institute

Want a good-pay job in the fast-growing RADIO-TELEVISION Industry? Want a money-making Radio-Television shop of your own? Here's your opportunity. I've trained hundreds of men to be Radio Technicians... **MEN WITH NO PREVIOUS EXPERIENCE.** My tested and proved train-at-home method makes learning easy. You learn Radio-Television principles from illustrated lessons. You get practical experience building, testing, experimenting with **MANY KITS OF PARTS** I send. All equipment yours to keep.

Make EXTRA MONEY in Spare Time

The day you enroll, I start sending SPECIAL BROOKLETS that show you how to make EXTRA MONEY fixing neighbors' Radios in spare time. From here it's a short step to your own shop, or a good-pay Radio-Television servicing job. Or get into Police, Aviation, Marine Radio, Broadcasting, Radio Manufactur-

ing or Public Address work. And think of getting in on the ground floor of the booming Television Industry. Trained men are already in demand... new stations are going on the air, manufacturers are building over 100,000 sets a month, more and more homes are getting sets. The man who prepares now will reap rich rewards.

See What N. R. I. Can Do For You

Act now! Send for my **DOUBLE FREE OFFER.** Coupon entitles you to actual lesson, "GETTING ACQUAINTED WITH RECEIVER SERVICING," absolutely free. Over 80 pictures and diagrams! You also get my 64-page book, "HOW TO BE A SUCCESS IN RADIO AND TELEVISION-ELECTRONICS." Tells more about YOUR opportunities, details of my Course; how quickly, easily you can get started. Send coupon in envelope or paste on penny postal. J. E. SMITH, President, Dept. 9EX, National Radio Institute, Pioneer Home Study Radio School, Washington 9, D. C.



I TRAINED THESE MEN



Makes \$60 A Week Plus Bonus
"I am Radio Serviceman for The Adams Appliance Co. Am now getting \$60 a week, plus bonus and overtime."—W. A. ANGEL, Rlytheville, Arkansas.



Learn Nothing About Radio
"I knew nothing about Radio when I enrolled. I am doing spare time work. I have more than paid for my Course and about \$200 worth of equipment."—RAYMOND HOLT CAMP, Vandalia, Illinois.

VETERANS
You can get this training without cost under G. I. Bill.

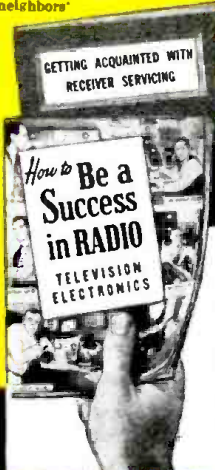

Good for Both—FREE

MR. J. E. SMITH, President, Dept. 9EX
National Radio Institute, Washington 9, D. C.

Mail me FREE Sample Lesson and 64-page book. (No salesman will call. Please write plainly.)

Age.....
Name.....
Address.....
City..... Zone..... State.....
 Check if Veteran

MY COURSE INCLUDES **TELEVISION**

RADIO — ELECTRONICS

formerly RADIO-CRAFT

Incorporating
SHORT WAVE CRAFT • TELEVISION NEWS •
RADIO & TELEVISION

* Trademark registered U. S. Patent Office

177,000 COPIES
OF THIS ISSUE
DISTRIBUTED

Hugo Gernsback, Editor-in-Chief
Fred Shunaman, Managing Editor
M. Harvey Gernsback, Consulting Editor
Robert F. Scott, W2PWG, Technical Editor
R. H. Dorf, W2QMI, Associate Editor
J. Queen, W2OUX, Editorial Associate
Angie Pascale, Production Manager
Elmer Fuller, Shortwave Editor
Wm. Lyon McLaughlin,
Tech. Illustration Director
G. Aliquo, Circulation Manager
Charles K. Brett,
National Advertising Director
John J. Lamson,
New York Advertising Director
Alfred Stern, Promotion Manager

Contents

May, 1949

Editorial (Page 19)	by Hugo Gernsback	19	
The Radio Technician	by Hugo Gernsback	19	
Television (Pages 20-31)		20	
Eight-Tube Televiser	by Dr. Lee de Forest	23	
Television Trends	by Ernest J. Schultz	24	
All-Channel TV Tuner	by Steve Lamareux	26	
Students Build TV Transmitter		27	
Experimental TV Relay (Cover Feature)		30	
Antennas for Television, Part V	by Edward M. Nall and Matt Mandl	30	
Electronics (Pages 32-37)		32	
Electret Behavior	by Edward D. Padgett	32	
Electronics in Medicine	by Eugene J. Thompson	35	
Construction (Pages 38-41)		38	
Build a Transistor	by Rufus P. Turner, K6A1	38	
Photoflash Unit for Your Camera	by W. C. Brown	40	
Broadcasting and Communications (Page 42)		42	
Telephone Lines in Broadcasting, Part II	by Leigh L. Kimball	42	
Test Instruments (Pages 43-47)		43	
Coupling Capacitors Can be Troublesome	by John T. Bailey	44	
Survey of Multitesters	by Rufus P. Turner and Robert F. Scott	44	
Novel Bridge Rectifier Circuit	by H. B. Conant	47	
Servicing (Pages 48-54)		48	
Radio Set and Service Review (Air King A725 Wire Recorder)		48	
Service Notes on Philco Sets	by W. G. Eslick	49	
Fundamentals of Servicing, Part IV	by John T. Frye	50	
Television and FM Alignment	by Douglas H. Carpenter	52	
Radio Science (Pages 55-58)		55	
Microwaves, Part II	by C. W. Palmer	55	
Audio (Pages 60-61)		60	
Audio Impedance Matching	by Walther Richter	60	
FM (Pages 68-69)		68	
FM Set Installed in Car	by Max Alth	68	
Foreign News (Pages 70-72)		70	
European Report	by Major Ralph W. Hallows	70	
French Radio Components		72	
Amateur (Page 79)		79	
Getting Started on 160		79	
Departments			
The Radio Month	10	World-Wide Station List	82
Radio Business	16	by Elmer R. Fuller	82
New Devices	62	People	86
New Patents	66	Technotes	88
The Question Box	74	Miscellany	89
Radio-Electronic Circuits	76	Communications	92
Try This One	80	Book Reviews	97

ON THE COVER: Experimental Television Relay Station W3XBR; Dick Hughes and R. Barrett in front of the shack. Kodachrome by Avery Slack. See article on page 27.

RADIO-ELECTRONICS, May, 1949, Volume XX, No. 8. Published monthly. Publication Office: Erie Ave., P. O. Box 100, Philadelphia 32, Pa. Entered as second class matter September 27, 1948, at the post office at Philadelphia, Pa., under the Act of March 3, 1879. **SUBSCRIPTION RATES:** In U. S. and Canada, in U. S. dollars, \$3.50 for one year, \$6.00 for two years, \$11.00 for three years. Allow one single copy 30c. All other foreign countries \$4.50 a year, \$8.00 for two years, \$11.00 for three years. Allow one single copy 30c. When ordering a change please furnish an address stencil impression from a recent wrapper. **RADIO-CRAFT PUBLICATIONS, INC.** Hugo Gernsback, Pres.; M. Harvey Gernsback, Vice-Pres.; G. Aliquo, Sec'y. Copyright, 1949, by Radio-Craft Publications, Inc. Text and illustrations must not be reproduced without permission of copyright owners.

EDITORIAL and ADVERTISING OFFICES: 25 West Broadway, New York 7, N. Y. Tel. REctor 5-9899. **BRANCH ADVERTISING OFFICES:** Chicago: 308 W. Washington Street, Telephone RAinbold 6-7363. Los Angeles: Ralph W. Barker, 606 South Hill St. Tel. TUcker 1-933. San Francisco: Ralph W. Barker, 582 Market St. Tel. GARfield 1-2181. **FOREIGN AGENTS:** Great Britain: Atlas Publishing and Distributing Co. Ltd., 18 Bride Lane, Fleet St., London E.C.4. Australia: McGills Agency, 179 Elizabeth Street, Melbourne. France: Brentano's, 37 Avenue de l'Opera, Paris 2e. Holland: Trilectron, Heemsteedsche Dreef 124 Heemstede. Greece: International Book & News Agency, 17 Amerikis Street, Athens. So. Africa: Central News Agency, Ltd., Cor. Risik & Commissioner Sts., Johannesburg. 112 Long Street, Capetown; 369 South Street, Durban, Natal. Universal Book Agency, 70 Harrison Street, Johannesburg. **Middle East:** Sleinatzky Middle East Agency, Jaffa Road, Jerusalem. India: Sushil Gupta (Distributors) bldg., Armita Bazar Patrika Bldg., 14 Anania Charterfree Lane, Calcutta. Broadway News Centre, Post Bag #5557, Daula, Bombay #14, K. L. Kannappa Mudaliar, 30 General Patters Road, Mount Road, Madras 2. Pakistan: Paradise Book Stall, Opp. Regal Cinema, Preech St., Karachi 3.

Editorial and Executive Offices:
25 West Broadway, New York 7, N. Y.



MEMBER
AUDIT BUREAU OF CIRCULATION



for MAXIMUM PERFORMANCE

Jim Lansing Signature Speakers will provide an almost unbelievable realism. The experience gained through a quarter of a century of leadership in the sound reproduction field has gone into their development and design. For maximum dynamic range and frequency response compare Jim Lansing Signature Speakers before you buy.



MODEL D-130



MODEL D-1002
TWO WAY SYSTEM

Designed especially for music systems and public address use. Has exceptionally high efficiency. Recommended for operation and frequencies from 60 to 6500 C.P.S. with a maximum usable range of 40 to 15000 C.P.S.

Designed especially for FM Monitoring and high quality home sound reproduction. Housed in a beautiful console type cabinet.



Write for Descriptive Catalog containing complete specifications.

SEE YOUR JOBBER OR
SEND DIRECT

**JAMES B. LANSING
SOUND INC.**
7801 HAYVENHURST AVENUE
VAN NUYS, CALIFORNIA

The Success Story of Bill Smith... OR YOU!



Mails coupon to National Schools in Los Angeles, and receives Free Lesson and book of Information about Radio, Television and Electronics training.



Enrolls... studies in spare time. Finds personal attention from instructors, interesting material and practical equipment, all increase his interest.



Builds actual units as part of Course. Earns money doing spare time repair and installation work.



Completes Course and receives Diploma... is now a qualified Radio, Television and Electronics Technician.



Applies for—and GETS—a good pay, full time job in industry. Finds that employers know National Schools and like to hire their graduates.



Or he opens own profitable Service Shop, with valuable counsel and aid from National Schools. Now for real happiness and success!



GET INTO RADIO, TELEVISION and ELECTRONICS by NATIONAL SCHOOLS SHOP METHOD HOME TRAINING

You Build This Superheterodyne Receiver With Parts We Send

You receive complete standard equipment, including latest type High-Mu Tubes, for building various experimental and test units. You progress step by step until you build a complete Superheterodyne Receiver. It is yours to use and keep.

Professional Multitester Included!

This portable instrument (see right) enables you to perform many practical tests, make delicate adjustments and do service work. Complete with test leads.

You receive a series of special laboratory experiment lessons to guide your practical exercises with your equipment. These lessons have been prepared with a special technique of illustrating radio principles by numerous easy-to-understand examples.

Both Resident and Home Study Courses Offered

Send Coupon Today for These Two Valuable Free Books

THIS PRACTICAL, TECHNICAL RESIDENT TRADE SCHOOL TRAINS YOU AT HOME FOR BIG RADIO OPPORTUNITIES!

Never in history has such rapid progress been made as in the great Radio, Television and Electronics Industry today! This exciting, fast-moving development means new and greater opportunities for the trained, skilled man—for you—in Television and Radio Broadcasting, Installing, Servicing; in Frequency Modulation; in Applied Electronics in many industries; in a business of your own!

National Home Training is Practical
Your National Schools Course fully covers basic, advanced and specialized instruction in all phases, including basic radio principles, receivers, am-

plifier systems, transmitters, television, aviation radio, electronics. You get complete instruction material, including shop manual, tube manual, job sheets, radio dictionary, special laboratory experiment lessons, experimental equipment. You receive complete, modern television lesson texts.

Your Home Study is supervised by our staff of highly trained instructors who daily teach our resident students here. Let the Free Books shown below tell you more about National Home Training. Use coupon today!

APPROVED FOR VETERANS

NATIONAL SCHOOLS

LOS ANGELES 37, CALIF. • EST. 1905



FIND OUT NOW... MAIL COUPON TODAY

National Schools, Dept. 5-RER (Mail in envelope 4000 South Figueroa Street or paste on Los Angeles 37, California postcard)

Mail me FREE the book, "Your Future in Radio," and a sample lesson of your course.

NAME..... AGE.....

ADDRESS.....

CITY..... ZONE..... STATE.....

Check here if veteran of World War II

BUY A 12-INCH ALNICO 5 "COAXIAL" P. M. SPEAKER AT MCGEE FOR \$10.95

12 INCH COAXIAL MODEL CN-12X \$10.95

Designed by one of America's finest speaker builders. Made for FM high fidelity radio, record players and P. A. systems. This speaker is incorporated in a rugged cabinet with a 12" driver and an exceptionally desirable 1 1/2" Alnico V magnet PM for the low range and a coaxially built-in 3" Alnico V tweeter. The high pass filter is concealed under the pot cover. Just hook to any 8 ohm output transformer (with 8 ohm voice coil) or to 18 MC 3 gang tuning condenser, with an 8 ohm voice coil. Only 2 wires to connect, will handle 18 watts peak. Frequency response, 50 to 17,000 CPS. This coaxial PM speaker should sell for \$35.00. Why buy an ordinary speaker, when we offer you a speaker of the future: for only \$10.95. Stock No. CN-12X. Weight 8 lbs. \$10.95, 2 for \$20.95

DELUXE 12 INCH COAXIAL MODEL CR-13X \$12.95

A regular \$37.50 hat speaker. The same basic design as the model CN-12X, described above, but furnished with 6.3 oz. magnet in the 12" woofer. Frequency response, 40 to 17,000-CPS. Has more mellow tone than CN-12X. Weight 9 lbs. \$12.95, 2 for \$24.95

15 INCH SUPER HEAVY DUTY \$24.95 COAXIAL P. M. SPEAKER

"IT WOOFAS AS IT TWEETS"

The King Coax. A 21.5 oz. 15 inch Alnico V PM speaker with a built-in high frequency tweeter. Will respond to from 30 to 12,000 cycles. This is a ruggedly built speaker with a curvilinear one piece molded cone. Built-in high pass filter. Just hook to any 8 ohm output. Built by the maker of our ever popular 12 inch coax model CR-12X. This speaker has a retail list of over \$50.00. We offer you our \$-15X 15 inch coax for only \$24.95. Weight 22 lbs.



8-TUBE RADIO KIT 2-BAND \$16.95

Kit Model 6-AC. A complete kit of parts, tubes and ready-punched chassis (no cabinet), to build a fine 6-Tube AC transformer type radio. We furnish every piece as well as printed diagram and photo. Chassis size 14x 7 1/2 x 7. 6-inch lighted slide rule dial. Receives broadcast and foreign short wave. 18 MC 3 gang tuning condenser. Pre-selector on both bands. 6V6 Output. This kit goes together like a manufactured radio. Made from parts intended for use by Detroit. Priced complete with tubes. Include postage for 10 lbs. Model 6-AC. Net \$16.95.

8-TUBE 2-BAND RADIO-P.A. KIT \$29.95

Kit Model 6-AC. A complete kit of parts, tubes and ready-punched chassis (no cabinet), to build a fine 6-Tube AC transformer type radio. We furnish every piece as well as printed diagram and photo. Chassis size 14x 7 1/2 x 7. 6-inch lighted slide rule dial. Receives broadcast and foreign short wave. 18 MC 3 gang tuning condenser. Pre-selector on both bands. 6V6 Output. This kit goes together like a manufactured radio. Made from parts intended for use by Detroit. Priced complete with tubes. Include postage for 10 lbs. Model 6-AC. Net \$16.95.

GAROD Personal Portable RADIO KIT \$14.95

A complete kit of parts to build a genuine garod radio. Only 6 1/2 x 3 1/4 x 4 in. Weight only 3 1/2 lbs. A real tiny personal battery radio. Everything furnished including batteries and assembly instructions. A superhet broadcast circuit with miniature parts. Metal case with plastic lid that turns radio on when opened. 4 tubes—1A5, 6X4, 6X5 and 384. This personal portable will build up into a commercial radio. Diagram and photos furnished. Stock No. X-43; weight 4 lbs. with 67.5 volt B and 1 1/2 volt A. Net \$14.95.

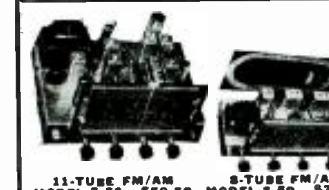

Model 5-56 Hallicrafters, high fidelity, 11 tube AM-FM Radio receiver chassis for custom installations. Receives standard broadcast 540 to 1700 KC and 88 to 108 MC. Automatic frequency control on FM, holds the receiver in perfect tune. Phono connection on rear. Frequency response essentially flat from 50 to 14,000 CPS. Wide vision accurately calibrated slide rule dial, with pre-selection on broadcast band. Output transformer matches 500 ohm line, 4 Antenna terminals; two for AM and two for FM. This is the finest tube home radio that we know of today. Better get your order in early. Dealer's net on this chassis is \$110.00. However, a lucky purchase, enables us to offer these brand new, factory cartoned 56 Hallicrafters Chassis, complete with tubes and 500 OHM to voice coil \$2.50 extra. Weight 25 lbs.

REGULAR \$35.00 LIST "JUKE BOX" 15 INCH \$9.95 P.M. SPEAKER SALE PRICE HAS NEW MOLDED CONE

A carload purchase, from a number one builder of fine PM speakers, enables us to offer this regular \$35.00 list 15" speaker for only \$9.95. This speaker is incorporated in a rugged cabinet with a 12" driver and an exceptionally desirable 1 1/2" Alnico V magnet, will take 18 watts average audio and 25 watts peak. If you want a speaker to woof out the low notes, buy this model. This is without a doubt the most speaker for the money that is available today. Include postage for 11 lbs. Stock No. 15-KR. Net price \$9.95.

KINGJUKE 50-WATT 15-INCH P.M. SPEAKER SCOOP PRICE \$14.95

Model 15-LS—The KING of all juke box speakers. Frequency response as low as 30 cycles. Will take 50 watts peak audio and 35 watts average, with ease. The most efficiently designed juke box speaker today. It will give you twice the air movement of an ordinary speaker. Has 1 1/2" 8 ohm voice coil and molded one piece curved cone. Designed to retail for \$50.00. Include postage for 18 lbs. Stock No. 15-LS. Net price \$14.95, 2 for \$29.95.

50-WATT 12-INCH P.M. SPEAKER SCOOP PRICE \$14.95

Model A-50—12" 50 watt super heavy duty permanent magnet speaker. Has 1 1/2" 8 ohm treated voice coil and one piece molded cone. Heavy half inch machined pot, with bolt secured 21 oz. Alnico V magnet. Frame is of heavy construction with metal pot cover. Finished in silver-grey enamel. This speaker is the best value possible today. Efficiency is two to three times that of ordinary speakers. Especially recommended for all public address systems and high quality home audio systems. Will handle 35 watts with ease and 50 watts peak for short lengths of time. Its retail value is \$50.00. But, by our large purchase, we are able to offer it to you for only \$14.95. Do not confuse this speaker with surplus merchandise. This is the latest production. Model A-50. Weight 15 lbs. Net \$14.95, 2 for \$29.95.

DELUXE 5-TUBE AC-DC KIT \$9.95 OUR LEADER

Made from Detroit Components A full line 5-tube radio kit housed in a 13-inch wood cabinet with full plastic front. Lighted slide rule dial, incorporates standard 2 band and 18 MC 3 gang tuning antenna, ready punched chassis, etc. This is another one of our line production radio kits. Every part is furnished including tubes, 12BA6, 12BE6, 12AT6, 50Y5 and 35W4. Diagrams, photos and instructions are included. 3" dynamic horn level level broadcast 550 to 1650 kc. Weight 9 lbs. Kit Model TP-6C. Net \$9.95.

PORTABLE RECORD PLAYER KITS IN CAPITOL LEATHERETTE CASE

Deluxe portable electronic record player kit—deluxe carrying case. Includes all material necessary as easy to wire diagram. Comes complete with every necessary part including phono motor, pickup, 5" PM speaker and all necessary parts to build 70L7 amplifier. Stock No. CK 1. Net Price \$9.95. Weight 4 lbs.

DELUXE PORTABLE PLAYER KIT \$14.95

Complete record player. Component parts clearly separately ready wired and tested. Amplifier has four tubes, 12SQ7, 2-11Z5, 50L6. All parts are included. Every part is furnished including tubes, heavy duty PM speaker and amplifier, with tone and volume control. Deluxe carrying wooden case with rich brown leatherette and has chrome fittings and speaker grill. Stock No. CC-8. Net price \$14.95. Model 1-P-CC8—Same as above only Dual speed with 2 pickups. \$19.95.

CHILDREN'S PLAYER KIT \$7.95

New, children's electronic player. Offered in kit form. Includes all material necessary. Attractive red plywood (not pictured) cabinet, self-starting phono motor and crystal pickup. 4-50L6 PM speaker and parts to build 70L7 amplifier. Diagram included. Stock No. LJ-1. Net Price \$7.95.

HALLICRAFTERS 11-TUBE FM-AM CUSTOM REC. CHASSIS \$1100 VALUE \$59.50 MCGEE'S SALE PRICE

Model 5-56 Hallicrafters, high fidelity, 11 tube AM-FM Radio receiver chassis for custom installations. Receives standard broadcast 540 to 1700 KC and 88 to 108 MC. Automatic frequency control on FM, holds the receiver in perfect tune. Phono connection on rear. Frequency response essentially flat from 50 to 14,000 CPS. Wide vision accurately calibrated slide rule dial, with pre-selection on broadcast band. Output transformer matches 500 ohm line, 4 Antenna terminals; two for AM and two for FM. This is the finest tube home radio that we know of today. Better get your order in early. Dealer's net on this chassis is \$110.00. However, a lucky purchase, enables us to offer these brand new, factory cartoned 56 Hallicrafters Chassis, complete with tubes and 500 OHM to voice coil \$2.50 extra. Weight 25 lbs.

4-TUBE T.R.F. KIT BARGAIN SPECIAL \$6.95

4 tube AC-DC. TRF radio kit. Ideal for student and beginner. Every part furnished to build this kit, including tubes, diagram and photo. Has Alnico V PM speaker and tubes, 12Y7, 12X7, 6X4, 6X5 and 35W4. Plastic cabinet with airplane dial. Receives broadcast 550 to 1600 KC. This is the easiest type of radio to build. Kit Model TP-4. Weight 6 lbs. Net \$6.95.

100 assorted 1/2 and 1 watt resistors all late production insulated type; assorted from low sizes to 16 meg 100 for \$3.00 Beldon 100 watt soldering iron—a \$3.00 value for \$1.95.

\$250.00 MAGNETIC TAPE RECORDER \$149.50

A regular \$250.00 list National known Magnetic tape recorder. Makes half hour recordings on standard tape. An AC amplifier housed in an attractive leatherette portable case. furnished complete with mikes. For more information write our descriptive circular.

6-VOLT POWER SUPPLY SCOOP \$2.95

1 1/2 Volt—90 Volt Vibrator Power Supply. Makes 1 1/2 Volt portable radion work on 6 Volt low sizes to 16 meg 100 for \$3.00 pack plug. Worth \$10.00. Sale price \$2.95. Stock No. X-VT. Weight 6 lbs.

1948 MODEL—MIKE-BROADCASTER ONLY \$6.95 COMPLETE KIT

Broadcasts 400 to 1500 KC from either a phono-graph pick-up or a crystal or dynamic mike. Makes any radio receiver a P.A. Gives broadcast quality. Has fader control from mike to record, simulating a regular broadcast station. This is a powerful model; using 2-384, 12SQ7 and 35W4 tubes. Priced with tubes and wiring instructions. Works on 110 volts AC-DC. Crystal mike and desk stand \$4.95 extra. Model SE-8X. Truly a de-luxe mike-phonograph.

TELEVISION CHASSIS \$5.95 SCOOP

Farnsworth Television Chassis Model GV260 partially built up Chassis Size 12x17. Has 17 tube sockets and over 150 small parts (Resistor and Ceramic Condensers) no coils or Transformers or tuning unit. Sweep and sync. circuits are all readily wired up. This T.V. Chassis is ideal for the student and experimenter. Learn T.V. by building your own set using this chassis to start from. Furnished with a 1948 regular \$3.00 Supreme Publications Television Manual, complete schematic of chassis and 9 pages of service information. Farnsworth GV260 partially built up Chassis and desk stand \$5.95 extra. Model SE-8X. Include postage for 14 lbs. GV260 Chassis only \$2.95.

OUTPUT TRANSFORMER HIGH FIDELITY 20-20,000 C.P.S. SCOOP PRICE \$6.95 EACH

Why pay \$20.00 or \$30.00 for an output transformer of high fidelity output? We have the answer. Designed to match push-pull plates (2-6L6, 2-6V6, or 2-6AQ5) class A to 4-8 3-250 and 500 ohm; with 100% feedback winding. Housed in a compound filled case; 3 1/2 x 4 1/2 x 3". Actual net weight, 6 lbs. If you want the best quality from your audio system, order this transformer. Response essentially flat from 20 to 20,000 cycles. We have tried several high fidelity outputs in our lab and find this to be the best value. Even though your amplifier only puts out 10 or 15 watts, this 34 watt job is what you should have. Connecting instructions are furnished. Stock No. A-403, shipping weight 8 lbs. Net price \$6.95

THEATRE QUALITY AMPLIFIER KIT \$75.00 Value ONLY \$24.95

Complete 15 watt true-fidelity audio amplifier kit. Response essentially flat from 20 to 7,000 cycles. Inputs for crystal mike and any phono pick up, crystal, magnetic or general electric variable reluctance. 3 controls and fader control. Merit high fidelity output transformer matches 4, 8, 16, 250 and 500 ohm line. Complete with miniature tubes, 6P 6AQ5 in output Diagram, photo and assembly instructions. Ready punched chassis, Kit model ME 15R Net \$24.95. Lab. wired and tested \$34.95. Speakers recommended. Aitec 1 1/2 inch model 603B. Net \$63.00.

Kit Model ME-34R, same as ME-15R, except has push-pull 4L6 Output tube. Giving 34 Watts of Audio. Weight 21 lbs. Net \$34.95.

12-WATT A.C. AMP KIT \$10.95

Amplifier Kit. Kit Model TM-12 12 Watt true fidelity audio amplifier. Ideal record player as well as public address or recording amplifier. Matched component parts. Ready punched chassis. Photo and instructions from phono to microphone. Gain enough for crystal or dynamic microphone. 100 Mill. Ps. or Transformer. 110 Volt AC 60 Cycle operation. Priced complete with tubes, 2-6V6, 2-12AX7 and rectifier. Diagrams and photos included. Weight 8 lbs. Kit Model T-2. Net \$10.95.

8 WATT AC AMPLIFIER KIT \$8.95 WITH PUSH PULL 6AQ5

A complete 8 Watt Output Amplifier for 110 Volt AC operation. Inputs for mike and phono pickup. Variable tone and fader control. Variable tone and fader control. Ready punched chassis. Photo and instructions. Priced complete with tubes, 2-6AQ5, 2-12AX7 and 5Y3. This amplifier will make a fine audio system. Remember this is not an ordinary AC-DC Amp. but an AC job with 75 Mill Power Transformer. Kit Model TM-8. Weight 10 lbs. Net \$8.95. Crystal Mike & Desk Stand \$4.95 extra. 12 Inch Alnico V PM Speaker \$4.95 extra.

5-WATT AMPLIFIER KIT \$6.95

A complete Kit of parts to build a 5 Watt Audio Amplifier, for 110 Volt AC-DC operation. Inputs for mike and phono pickup. Variable tone and fader control. Ready punched chassis. Photo and instructions. Priced complete with tubes, 2-6V6, 2-12AX7, pluselenium rectifier. Offered at the usual price of a single output type Amp. Kit Model TM-5. Weight 6 lbs. Net \$6.95. Crystal Mike & Desk Stand \$4.95 extra. 12 Inch PM Speaker \$4.95 extra.

20-WATT AMP KIT \$15.95 PUSH-PULL 6L6

A complete kit of parts to build a high quality 20 Watt Audio Amplifier with 110 Volt AC operation. Inputs for mike and either crystal or variable reluctance pick ups. Tone and fader controls. Has heavy duty Universal Output Transformer to match any speaker. 4-8 16-250 and 500 ohm. Inputs for mike and phono pickup. Ready punched chassis. Photo and instructions. Priced complete with tubes, 2-6L6, 2-7N7, 7Z4. Kit Model TM-20. Weight 10 lbs. Net \$15.95. Crystal Mike & Desk Stand \$4.95 extra. Speaker recommended Model CR-13X \$12.95 extra.

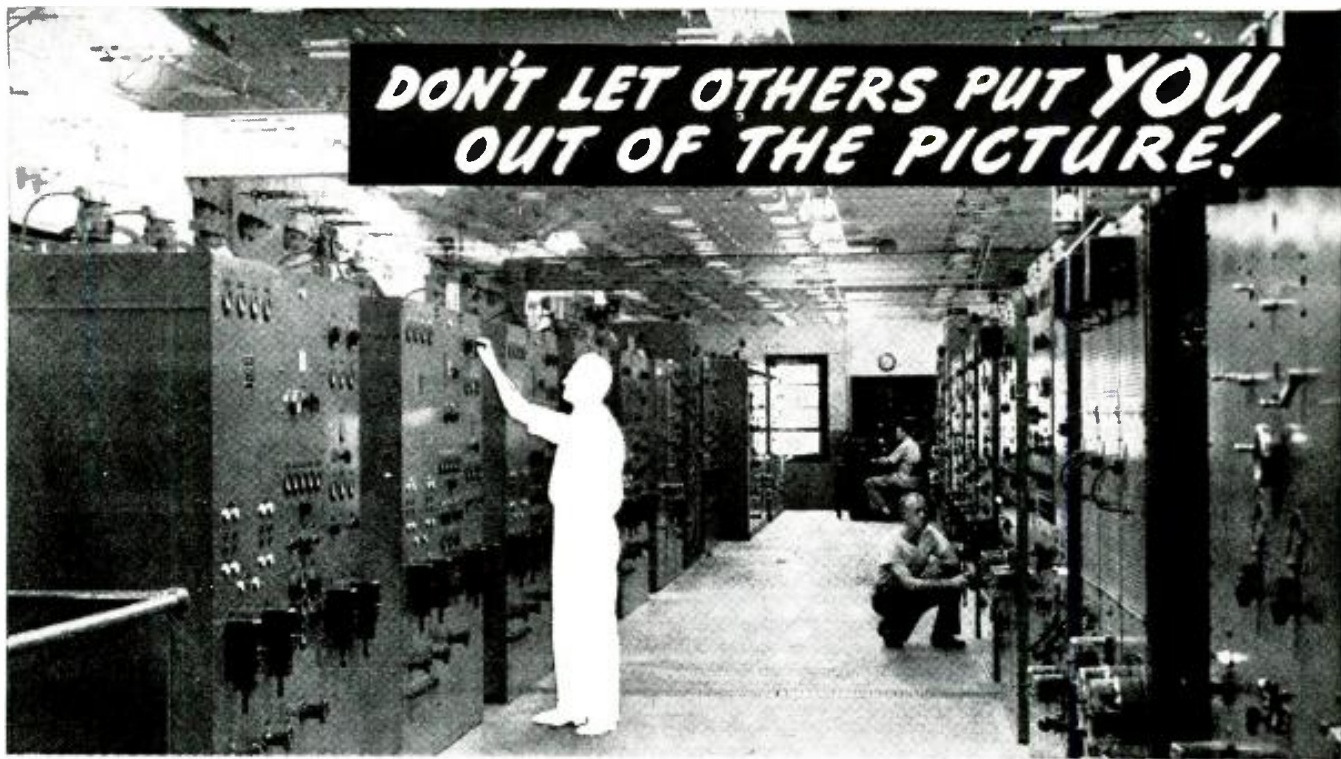

Here's How CREI Home-Study Training Prepares You NOW For a BETTER Job and a Secure Future in Radio-Electronics and Television

CREI Courses for Every Radioman Keep You Ahead of Competition—Earn You More! Never before have so many men like you had the opportunity to step ahead into better-paying jobs and enjoy lasting success. Men with up-to-date technical training are needed in every branch of radio-electronics. That's because radio's *manpower* has not kept pace with radio's *technical* developments.

What are you doing to meet this need for highly trained, expert technicians and engineers? You must improve your technical knowledge not only to qualify for the better job you want, but to *hold* the job you now occupy. CREI offers you a proved program of technical self improvement that you can study in your spare time, at home. The same

type of practical, down-to-earth training for which thousands have enrolled since 1927.

Remember, too, there's a CREI course for *you*. No matter what your radio experience—CREI offers complete training in radio-electronics for *any* man who wants to improve his ability and his chances for advancement. You can "*go all the way with CREI*" from introductory basic principles to advanced training and on to specialized engineering subjects.

Read our new 32-page booklet . . . then judge for yourself. There is no obligation. You are already started in this field. Find out how you can rapidly prepare to advance beyond your present level. Send the coupon NOW!

VETERANS! CREI TRAINING AVAILABLE UNDER G.I. BILL

If you have had professional or amateur radio experience and want to make more money, let us prove to you we have the training you need to qualify for a better radio job. To help us answer intelligently your inquiry—*please state briefly your background of experience, education and present position.*



Capitol Radio Engineering Institute

An Accredited Technical Institute—Founded in 1927

Dept. 145-A, 16th and Park Road, N. W., Washington 10, D.C.
 Branch Offices: New York (7) 170 Broadway • San Francisco (2) 760 Market St
 MAY, 1949

MAIL COUPON FOR FREE BOOKLET

CAPITOL RADIO ENGINEERING INSTITUTE
 16th & Park Road, N. W., Dept. 145-A, Washington 10, D. C.
 Gentlemen: Please send your free booklet, "Your Future in the New World of Electronics," together with full details of your home-study training. I am attaching a brief resume of my experience, education and present position.
Check field of greatest interest:

- Broadcast Radio Engineering (AM, FM, TV)
- Practical Radio Engineering
- Television, FM & Advanced AM Servicing
- Aeronautical Radio Engineering
- Advanced Electronic Communications
- Practical Television Engineering
- Radio-Electronics in Industry

NAME.....
 STREET.....
 CITY.....ZONE.....STATE.....
 I AM ENTITLED TO TRAINING UNDER G. I. BILL

See how we may help you
get started toward a

profitable, exciting future in

TELEVISION RADIO-ELECTRONICS

Get the facts about our
GREATEST OFFER IN 17 YEARS

Here's your big chance to get started toward **FASCINATING WORK** . . . **GOOD MONEY** . . . a **THRILLING FUTURE!** Mail the coupon today. See how **YOU** may prepare to tie in your future with a field that includes one of America's fastest-growing new industries—Television. You'll find out, too, about the many other thrilling opportunities in FM Radio . . . Aviation and Broadcast Radio . . . 2-Way Taxi, Truck and Police Radio . . . Industrial Electronics . . . even the chance to start your own profitable Television-Radio Sales and Service business. And to top it all, you'll see that you don't need to know a thing about this subject at present—that **NOW** you can get the very training and starting help you need by means of our **GREATEST OFFER IN 17 YEARS.**

Send for **FREE** information

See **HOW**—in your own home—DeForest's Training, Inc., now brings you one of today's most complete combinations of major home training aids. You (1) Learn-by-Reading from well-illustrated lessons. (2) Learn-by-Seeing from D.T.I.'s exclusive instructive Home Movies. (3) Set up your own **HOME LABORATORY** where you Learn-by-Doing from 16 shipments of Radio-Electronic parts which you use and **KEEP** to work over 300 instructive, fascinating projects. This includes building the valuable 6 tube "Superhet" **RADIO**, commercial-type **OSCILLOSCOPE**, **R-F SIGNAL GENERATOR**, and Jewel-Bearing **MULTI-METER**, pictured at the right.

You may use this test equipment to help you earn real money—both in your spare time and later when working full time in the field. Get complete facts. Mail coupon today!

EMPLOYMENT SERVICE

When you complete your training, our effective Employment Service is available to you without extra cost—a grand aid to help you get started.

**MODERN
CHICAGO
LABORATORIES**

Train quickly, using a wide variety of commercial equipment. D. T. I.'s new laboratories are among the finest of their kind. Ample instructors . . . every major training advantage. Write for details.

OSCILLOSCOPE

MULTI-METER

R-F SIGNAL GENERATOR

6-TUBE RECEIVER

YOU BUILD and KEEP*
THIS EQUIPMENT TO
WORK OVER 300
HOME EXPERIMENTS

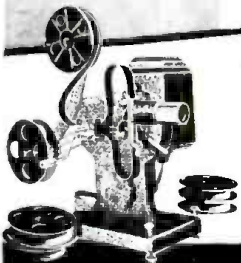

You also use **HOME MOVIES**

. . . a **D. T. I. Exclusive!** D. T. I., alone, includes the use of today's most effective training aids . . . **MOVIES** . . . to help you learn important fundamentals faster, easier at home. What an advantage to see electrons on the march, and other fascinating "hidden action"—a remarkable home training advantage that speeds your progress.

MAIL THIS OPPORTUNITY COUPON NOW!

DeForest's Training, Inc.
2533 N. Ashland Ave., Dept. RC-F5
Chicago 14, Illinois

Without obligation, send me complete facts showing how I may make my start in Television-Radio-Electronics.

Name Age
Street Apt.
City Zone State

DeFOREST'S TRAINING, INC.
CHICAGO 14, ILLINOIS

Affiliated with the DeVry Corporation, Builders of Electronic and Movie Equipment



Model 260 in
all-bakelite
roll top
carrying case

There are more
Simpson 260
high sensitivity
Volt-Ohm-Milliammeters
in use today
than all others
combined!
—your Parts Jobber
can tell you why

**RANGES at 20,000 ohms per volt DC,
1000 ohms per volt AC VOLTS:**

AC & DC—2.5, 10, 50, 250, 1,000, 5,000

DC CURRENT:

10, 100, 500, MA—10 AMP—100 MICRO AMP

OHMS:

0-2,000 (12 center), 0-200,000 (120 center),
0-20 MEGOHMS (120,000 ohms center)

DECIBELS:

(5 ranges) —10 to +52 DB



**SIMPSON
ELECTRIC
COMPANY**

5200-5218 W. KINZIE ST., CHICAGO 44, ILL.
IN CANADA: BACH-SIMPSON, LTD., LONDON, ONT.



JOHN H. POTTS, engineer, editor, author, and publisher, died March 16, at the age of 56. A heart ailment was the cause of death.

Mr. Potts was a graduate of the University of Chicago, in which city he was born. He came to New York in 1918 and worked as engineer with RCA, General Electric, Westinghouse, and Sperry before entering the publishing field.

He was best known to engineers as editor and publisher of *Audio Engineering* and editor of its predecessor, *Radio*. To amateurs he was equally well known as the founder and publisher of the amateur magazine *CQ*.

DANGEROUS SURPLUS equipment is reported from Michigan, where the State Police have broadcast a warning that more than 1,000 war-surplus radio sets have been sold with detonators attached to them.

According to State Police Commissioner Donald S. Leonard, the sets are IFF models BC-647-A and BC-966-A. Some of them have tubes six inches long and three-quarters of an inch in diameter, containing a detonator cap and a quantity of TNT, the purpose of which was to destroy the set should the enemy attempt to open captured equipment to seek information about its construction.

How the sets got into the surplus market with their detonators in place is not known. There have been sporadic reports of single sets discovered with detonators intact, and Australian amateurs were warned a few months ago that a quantity of IFF transmitter-receivers already in their hands were dangerous and would blow up if any attempt were made to open them. The explosive charge is small, but quite sufficient to injure any would-be investigator very seriously.

TELEVISION ANTENNAS can be removed from apartment house roofs if they were not authorized by the landlord, an all-tenant jury ruled in New York last month.

Mrs. Estelle Sherer refused to pay her rent for two months because the landlord took down her TV antenna. The landlord tried to evict and Mrs. Sherer counter-sued for three times the value of her receiver, saying that the removal of the antenna was a "partial eviction." The superintendent had given his permission for the installation, she testified, but last December an official of the owner corporation removed it from the roof.

In charging the jury, the judge stated that the superintendent could not permit an antenna installation because he was not an officer of the corporation. Furthermore, he said, referring to Mrs. Sherer's claim of partial eviction, the roof was not a part of her rented premises, and therefore she could not be "evicted" from it.

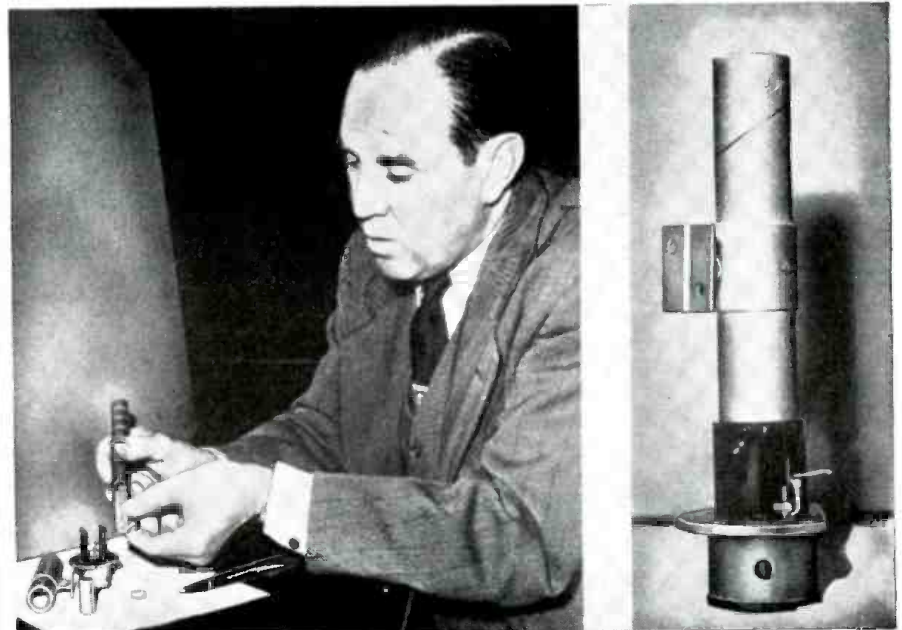

Left—Examining a detonator taken from a surplus set. Right—A closeup of the detonator.

EDWIN H. COLPITTS, 77, retired vice-president of Bell Telephone Laboratories and inventor of the Colpitts oscillator circuit, died on March 6. Dr. Colpitts held 24 patents and was noted for his work with magnetic coils, his efforts in adapting electron tubes for



long-distance telephone circuits, and his studies of capacity unbalance between adjacent telephone-line pairs.

Dr. Colpitts' telephone work began in 1899 when he joined the American Bell Telephone Company. He worked with the Armed Forces in both World Wars.

A. ATWATER KENT, at one time world's largest manufacturer of radio receivers, died in California March 4, at the age of 75. Atwater Kent's original radios were perhaps the only broadcast receivers ever to use "breadboard" mounting. Beautifully finished components were mounted above the board, and the wiring was carried in grooves on its underside. Turning to more conventional sets, he stepped his production up to a peak of 6,000 receivers a day, selling \$60,000,000 worth of sets in 1929.

DR. HARVEY RENTSCHLER, retired director of the Westinghouse experimental laboratory at Bloomfield, N. J., died March 23 at his home in East Orange, N. J.

Dr. Rentschler had carried on experimental work with lamps and electronic tubes since 1917, when he joined the Westinghouse staff. Before that he had been a professor of physics at the University of Missouri for nine years.

He was the author of numerous contributions to scientific publications, chiefly on electronic tubes and electric lamps, and was the holder of more than 100 patents, most of them in those two fields.

Possibly Dr. Rentschler's best-known invention is the Sterilamp, the ultra-violet light that destroys bacteria in the air. Less well known, but even more spectacular, was his feat of refining the first uranium used in the development of the atomic bomb.

OBsolescence of TV SETS will not be a problem, said Wayne Coy, chairman of the Federal Communications Commission last month. The statement was believed to be a reply to the many rumors that present television receivers would be useless in the near future if u.h.f. channels are adopted.

"The Commission would not be taking the time to revise the standards for the presently available service," said Mr. Coy, "if it had in mind eliminating in the near future the use of these channels for television service."

"I think this question of obsolescence of television receivers is something of a tempest in a teapot. I do not think that anyone buying a television set today has had a fraud perpetrated on them. I can assure them that wherever a television signal is available from a v.h.f. transmitter, their sets will render them fine service for many years and can be converted to render fine service for them if ultra-high frequencies are utilized. . ."

TELEVISION ANTIQUES are already in existence, it appears. Last month's National Antiques Show at Madison Square Garden in New York featured American items of every description—pre-revolutionary pottery, Pennsylvania Dutch cupboards, 19th century ball gowns, to mention a few items.

Right in the middle of the show, occupying its own small spot, was a 1938 RCA television receiver, one of the first commercial models made. Without radio or phonograph and able to tune only five channels, the 1938 set sold 11 years ago for \$850, almost twice what a modern combination instrument would cost on today's market.

WINDOW TV ANTENNAS may become more widespread in New York City as the result of a ruling in Bronx Supreme Court last month. Joseph Einson, a tenant in an apartment house, was in court with landlord D. Greenstein, Inc., to determine whether Mr. Einson's window antenna—objected to by the landlord—should remain. Justice Eugene L. Brisach ruled that it might remain, provided the tenant obtained liability insurance ranging from \$10,000 to \$20,000 to protect the landlord in case of any accident attributable to the antenna.

WWVH is the call of the new Bureau of Standards station recently established on the Hawaiian island of Maui. Time and frequency standards are being broadcast experimentally on 5, 10, and 15 mc. As with WWV, the Bureau's main station in Beltsville, Md., WWVH is modulated with a standard 440-cycle A, as well as audio pulses at accurate 1-second intervals. The audio tone starts at the hour and continues for 4 minutes, followed by 1 minute of silence; this sequence is repeated throughout the hour. Greenwich Mean Time is given in code every 5 minutes. All transmissions are interrupted for about 4 minutes on the hour and half-hour and for about 30 minutes at 0700 and 1900 GMT.

FOR DEMONSTRATING & TESTING AUTO RADIOS from AC LINES

ATR

Visit ATR Booth 82 Radio Parts Show May 16 to 20—Chicago

"A" BATTERY ELIMINATORS



for DEMONSTRATING AND TESTING AUTO RADIOS

New Models . . . Designed for testing D. C. Electrical Apparatus on Regular A. C. Lines. Equipped with Full-Wave Dry Disc Type Rectifier, Assuring Noiseless, Interference-Free Operation and Extreme Long Life and Reliability.



AUTO RADIO VIBRATORS

A Complete Line of Vibrators . . . Designed for Use in Standard Vibrator-Operated Auto Radio Receivers. Built with Precision Construction, featuring Ceramic Stack Spacers for Longer Lasting Life.

NEW MODELS NEW DESIGNS
NEW LITERATURE

ATR "A" Battery Eliminator, DC-AC Inverters, Auto Radio Vibrators

See your jobber or write factory
AMERICAN TELEVISION & RADIO CO.
Quality Products Since 1931
SAINT PAUL 1, MINNESOTA—U. S. A.

Heathkit TEST



Heathkit engineer measuring frequency response and distortion of Heathkit Oscilloscope using Hewlett Packard Audio Generator and Distortion Analyzer.

1949 MODEL Heathkit VACUUM TUBE VOLTMETER KIT



Features

- New 200 ua Meter. 24 Ranges.
- New Accessory H.V. Probe makes Heathkit a kilovoltmeter. (Extra)
- New Accessory RF Probe extends range to 100 megacycles. (Extra)

A new Model V-2 Heathkit VTVM with new 200 microampere meter, four additional ranges — full scale linear ranges on both AC and DC of 0-3 V., 10 V., 30 V., 100 V., 300 V. and 1,000 V. Accessory probe listed elsewhere in ad extends voltage range to 3,000 and 10,000 volts DC. New model has greater sensitivity, stability and accuracy — still the highest quality features — shatterproof plastic full view meter face — automatic meter protection, push pull electronic voltmeter circuit, linear scales — db. scale — ohmmeter measures 1/10 ohm to 1 billion ohms with internal battery — isolated DC test prod for dynamic measurements — 11 megohm input resistance on DC — AC uses electronic rectification with 6HG tube. All these features and still the amazing price of only \$24.50.

Comes complete with cabinet — panel — three tubes — new Mallory switches — test prods and leads, 1% ceramic divider resistors and all other parts. Complete instruction manual for assembly and use. Better start your laboratory with this precision instrument. Ship. Wt., 8 lbs.

\$24.50

Heathkit RF SIGNAL GENERATOR KIT

\$19.50

Nothing ELSE TO BUY

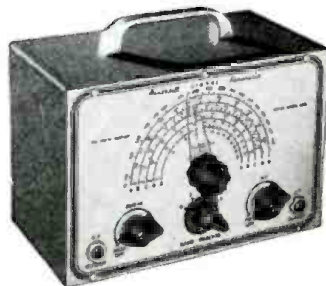

Every shop needs a good signal generator. The Heathkit fulfills every servicing need, fundamentals from 150 Kc. to 30 megacycles with strong harmonics over 100 megacycles covering the new television and FM bands. 110 V. 60 cycle transformer operated power supply. 400 cycle audio available for modulation or audio testing. Uses 6SN7 as RF oscillator and audio amplifier. Complete kit has every part necessary and detailed blueprints and instructions enable the builder to assemble it in a few hours. Large easy to read calibration. Convenient size 9" x 6" x 4 3/4". Shipping Wt., 4 1/2 lbs.

Heathkit 5" OSCILLOSCOPE KIT

Features

- Instant switching to plates or amplifier from front panel.
- Sweep generator supplying variable sweep 15 cycles to 30,000 cycles.
- All controls on front panel.
- Cased electrostatically shielded 110 V. 60 cycle power transformer.
- AC test voltage on front panel.
- External synchronization post on front panel.
- Deflection sensitivity .65 V. per inch full gain.
- Frequency response $\pm 20\%$ from 50 cycles to 50 Kc.
- Input impedance 1 Megohm and 50 MMF.

The Heathkit 5" Oscilloscope fulfills every servicing need. The husky cased power transformer supplies 1100 Volts negative and 350 Volts positive. Tubes supplied are two 6SJ7 amplifiers, 884 sweep generator, two 5Y3 rectifiers, and 5BP1 CR tube. Grey crackle aluminum cabinet and beautiful grey and maroon panel. Chassis especially designed for easy assembly.

An oscilloscope provides endless sources of experimentation in radio, electronics, medicine and scientific research.

Detailed instructions make assembly fun and instructive. Shipping Wt., 24 lbs. Express only.



\$39.50

Nothing ELSE TO BUY

New Heathkit SIGNAL TRACER AND UNIVERSAL TEST SPEAKER KIT

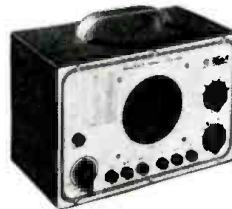

\$19.50

Nothing ELSE TO BUY

The popular Heathkit signal tracer has now been combined with a universal test speaker at no increase in price. The same high quality tracer follows signal from antenna to speaker — locates intermitents — defective parts quicker — saves valuable service time — gives greater income per service hour. Works equally well on broadcast — FM or TV receivers. The test speaker has assortment of switching ranges to match push pull or single output impedance. Also tests microphones, pickups — PA systems — comes complete — cabinet — 110 V. 60 cycle power transformer — tubes, test probe, all parts and detailed instructions for assembly and use. Shipping Wt., 8 lbs.

Heathkit ELECTRONIC SWITCH KIT

DOUBLES THE UTILITY OF ANY SCOPE

An electronic switch used with any oscilloscope provides two separately controllable traces on the screen. Each trace is controlled independently and the position of the traces may be varied. The input and output traces of an amplifier may be observed one beside the other or one directly over the other illustrating perfectly any change occurring in the amplifier. Distortion — phase shift and other defects show up instantly, 110 Volt 60 cycle transformer operated. Uses 5 tubes (1 6X5, 2 6SN7's, 2 6SJ7's). Has individual gain controls, positioning control, and coarse and fine sweeping rate controls. The cabinet and panel match all other Heathkits. Every part supplied including detailed instructions for assembly and use. Shipping Wt., 11 lbs.



\$34.50

Heathkit 3-TUBE ALL WAVE RADIO KIT



\$8.75

An ideal way to learn radio. This kit is complete ready to assemble, with tubes and all other parts. Operates from 110 V. AC. Simple, clear detailed instructions make this a good radio training course. Covers regular broadcasts and short wave bands. Plug-in coils. Regenerative circuit. Operates loud speaker. Shipping Wt., 3 lbs.

- HS30 Headphones per set.....\$1.00
- 2 1/2" Permanent Magnet Loudspeaker..... 1.95
- Mahogany Cabinet..... 2.95



The **HEATH COMPANY**

... BENTON HARBOR 20, MICHIGAN

EQUIPMENT must be good!

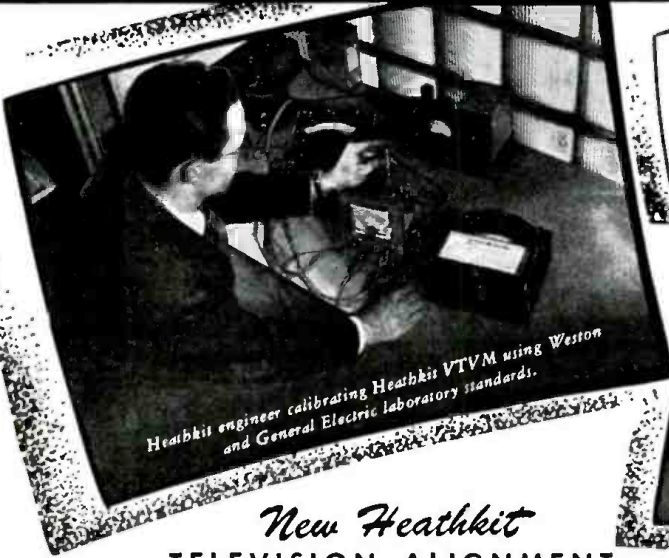

Heathkit engineer calibrating Heathkit VTVM using Weston and General Electric laboratory standards.

MATCHED TO THE HIGHEST PRECISION STANDARDS...



Heathkit technician calibrating condensers for Heathkit Condenser Checker using General Radio capacity bridge of 1% accuracy.

New Heathkit TELEVISION ALIGNMENT GENERATOR KIT

Everything you want in a television alignment generator. A wide band sweep generator covering all FM and TV frequencies—a marker indicator—AM modulation for RF alignment—variable calibrated sweep width 0-30 Mc.—mechanical driven inductive sweep. Husky 110 V. 60 cycle power transformer operated—step type output attenuator with 10,000 to 1 range—high output on all ranges—band switching for each range—vernier driven main calibrated dial with over 45 inches of calibrations—vernier driven calibrated indicator marker tuning. Large grey crackle cabinet 16-1/8" x 10-5/8" x 7-3/16". Phase control for single trace adjustment. Uses four high frequency triodes plus 5Y3 rectifier—split stator tuning condensers for greater efficiency and accuracy at high frequencies—this Heathkit is complete and adequate for every alignment need and is supplied with every part—cabinet—calibrated panel—all coils and condensers wound, calibrated and adjusted. Tubes, transformer, test leads—every part with instruction manual for assembly and use. Actually three instruments in one—TV sweep generator—TV AM generator and TV marker indicator. Also covers FM band. Deliveries start early in March. Order early.

\$39.50

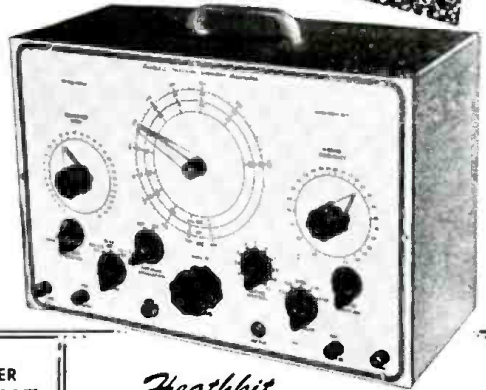

Heathkit SINE AND SQUARE WAVE AUDIO GENERATOR KIT



\$34.50
Nothing ELSE TO BUY

Experimenters and servicemen working with a square wave for the first time invariably wonder why it was not introduced before. The characteristics of an amplifier can be determined in seconds compared to several hours of tedious plotting using older methods. Stage by stage, amplifier testing is as easy as signal tracing. The low distortion (less than 1%) and linear output (\pm one db.) make this Heathkit equal or superior to factory built equipment selling for three or four times its price. The circuit is the popular RC tuning circuit using a four gang variable condenser. Three ranges 20-200, 200-2,000, 2,000-20,000 cycles are provided by selector switch. Either sine or square waves instantly available at slide switch. All components are of highest quality, cased 110 V. 60 cycle power transformer, Mallory F.P. filter condensers, 5 tubes, calibrated 2 color panel, grey crackle aluminum cabinet. The detailed instructions make assembly an interesting and instructive few hours. Shipping Wt., 13 lbs.

110 V. A.C. MILITARY RECEIVER POWER SUPPLY KIT



\$5.95

Ideal way to convert military sets. 110 V. 60 cy. transformer operated. Supplies 24 volts for filament—no wiring changes inside radio. Also supplies 250 V. D.C. plate voltage at 50-60 MA. Connections direct to dynamotor input. Complete with all parts and detailed instructions. Ship. Wt., 6 pounds.

Heathkit CONDENSER CHECKER KIT

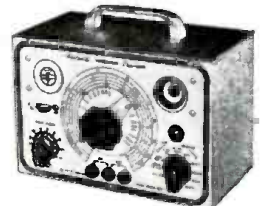

\$19.50
Nothing ELSE TO BUY

Features

- Bridge type circuit
- Magic eye indicator
- 110 V transformer operated
- All scales on panel
- Power factor scale
- Measures resistance
- Measures leakage
- Checks paper-mica-electrolytics

Checks all types of condensers, paper-mica-electrolytic-ceramic over a range of .00001 MFD to 1000 MFD. All on readable scales that are read direct from the panel. NO CHARTS OR MULTIPLIERS NECESSARY. A condenser checker anyone can read without a college education. A leakage test and polarizing voltage for 20 to 500 volts provided. Measures power factor of electrolytics between 0% and 50%. 110 V. 60 cycle transformer operated complete with rectifier and magic eye tubes, cabinet, calibrated panel, test leads and all other parts. Clear detailed instructions for assembly and use. Why guess at the quality and capacity of a condenser when you can know for less than a twenty dollar bill. Shipping Wt., 7 lbs.

110 V. A.C. TRANSMITTER POWER SUPPLY KIT



\$14.50

For BC-645, 223, 522, 274N's, etc. Ideal for powering military transmitters. Supplies 500 to 600 volts at 150 to 200 MA plate, 6.3 C.T. at 4 Amps., 6.3 at 4 Amps., and 12 V. at 4 Amps. Can be combined to supply 3-6-9-12 or 24 volts at 4 amperes. Kit supplied complete with husky 110 V. 60 cycle power transformer, 5U4 rectifier, oil filled condensers, cased choke, punched chassis, and all other parts, including detailed instructions. Complete—nothing else to buy. Shipping Wt., 22 lbs.



The **HEATH COMPANY**

... BENTON HARBOR 20, MICHIGAN



ELECTRONIC BARGAINS for EXPERIMENTERS and HOBBYISTS

ORDER NOW . . . ALL QUANTITIES LIMITED



PE101C BC645 POWER SUPPLY
NO. 273. Complete power supply for BC 645. Operates from 12 or 24 Volts. Supplies both AC and DC required. Shipping Wgt. 13 lbs. Each **\$3.95**

DM 35 12 VOLT DYNAMOTOR
NO. 274. New input 12 Volt at 18.7 Amperes. Supplies 675V at 275 MA or 1/2 above voltage from 6 volts. Excellent for auto use. Shipping Wgt. 11 lbs. Each **\$7.50**

HOME WORKSHOP GRINDER KIT

NO. 230. Easily assembled 110V AC or DC ball bearing fully enclosed motor from Army surplus dynamotor. Purchaser to make simple changes and shaft extensions, detailed instructions and all parts supplied. Motor approximately 5,000 R.P.M. Ideal for tool-post grinder, flexible shaft tool, model drill press, saw. Shipping Weight 6 lbs. **\$3.95**

COLLINS AUTOTUNE CONTROL HEAD

NO. 278. Brand new controls used on the ART/13, 100 Watt, Transmitter. Types 7, 8, 10, and 11 available. Get a spare while available as new cost is over \$22.00 each. Shipping Wgt. 3 lbs. Price any type (mention when ordering). Each **\$4.50**

300 MA SELENIUM RECTIFIERS
NO. 209. Rated 300 MA at 36 Volts, complete with mounting brackets. Shipping Wgt. 1 lb. 3 FOR **\$1.00**

1N90 FEED THROUGH INSULATOR

NO. 276. Heavy duty feed through, 2" diameter 4" long, complete with brass hardware and gasket. Shipping Wgt. 2 lbs. 2 FOR **\$1.00**

1N86 STRAIN INSULATOR
NO. 277. Husky army type 1 1/4" diameter, 5 1/4" long. Brown porcelain. Shipping Wgt. 4 lbs. 4 FOR **\$1.00**

G.E. BC 306 ANTENNA TUNING UNIT

NO. 231. Matches any aerial to 150 Watt transmitter, used on BC 375. Brand new. Add postage for 20 lbs. **\$2.95**

G. E. 1,000 VOLT 350 MA DYNAMOTOR

NO. 213. An ideal dynamotor for mobile operation in taxicabs, police cars, sound systems and amateur stations. Supplies above voltage from 12 Volts or 300V. at 350 MA from 6 Volts. Complete with starting relay, and fuses. New. Our Dynamotor A. Shipping Weight 72 lbs. **\$5.95**

POWER TRANSFORMER *Specials*

NO. 226. Primary 117V. 60 cycle. Secondaries supply 746 V.CT at 220 MA, 6.3V. at 4.5 A., and 5V. at 4A. Will handle 13 tube radio receivers. Supply is limited, order early. Shipping Weight 11 lbs. each. **\$3.95 . . . 3 for \$9.95**

T32 TABLE MICROPHONE

NO. 210. One of the Army's best. Built by Kellogg, ideal for factory call system, public address, amateur use. Brand new in original cartons. Add postage for 5 lbs. **\$2.95**

MINIATURE ELECTRIC MOTOR

NO. 211. Tiny Delco motor only 1" x 1 1/4" x 2" 10,000 RPM. Operates from 6 to 24 V. Excellent for models. Add postage for 1 lb. **\$2.95**

OUTPUT TRANSFORMER

NO. 227. Push pull 6V6's to 6-8 ohm voice coil excellent characteristics. 3 for **\$1.95**

RCA SATURABLE REACTOR TRANSFORMER
NO. 246. New RCA No. CKV30531 AC current 750 MA DC current 2 Amperes. Rated 1.75 henries. Shipping wgt. 4 lbs. Each **\$1.00**

12.6V POWER TRANSFORMER

NO. 247. New cased 110 V 60 cy. Power Transformer. Supplies 440V Ct. at 60 MA, 6.3V at 2A, and 12.6V at 1 Amp. Excellent for military sets. Shipping Wgt. 6 lbs. Each. **\$1.95**

RCA INPUT TRANSFORMER

NO. 248. Heavy duty RCA No CKV-30529. Input has primaries 600 to 200 and 25 ohms secondary 250,000 ohms C.T. Shipping Wgt. 2 lbs. Each **\$1.00**

FEDERAL POWER TRANSFORMER

NO. 252. New cased 110V 60 cy. Power Transformer. Supplies 480V CT at 50 MA and 6.3 V at 2.1 Amps. A beautiful transformer. Shipping Wgt. 4 lbs. Each. **\$1.50**

MILITARY POWER TRANSFORMERS

NO. 229. Convert your military receivers without rewiring the filament. "A" type supplies 500 VCT at 50 MA, 5V. at 2A. and 24V. at 1/2 A. "B" type supplies 500 VCT at 50 MA, 5V. at 2A. and 12V. at 1 Amp. State whether A or B type desired. **\$2.95** Shipping Weight 4 lbs.

WALKIE TALKIE TRANSFORMER

No. 744. Carbon microphone input transformer and output to telephone transformer, all in one case, excellent for building your own. Shipping Wt. 1 lb. 4 for **\$1.00**

LOW PASS FILTER UNIT

No. 637. 3000 cycle cutoff consists of 3 inductances and 4 capacitors in network, 500 ohms in and out. Excellent for clipping all frequencies above 3000 cycles. Drawn steel case, shipping Wt. 5 lbs. **\$2.50**

FM PUSH BUTTON TUNER

NO. 224. Brand new ten push button tuning assembly from Army FM receiver. Contains 4 gang 100 MMF silver plated tuning condenser. Add postage for 10 lbs. **\$2.50 EACH**

BC 746 TUNING UNIT

NO. 257. Plug in transmitter tuning unit from army Walkie Talkie. Contains antenna and tank coils, tuning condenser, transmitting and receiving crystals. Ideal transmitter foundation. Shipping Wgt. 1 lb. Each **\$1.00** (Same as above except transmitter crystal in 80 meter amateur band \$2.50 each)

T30 THROAT MICROPHONE

NO. 258. Makes excellent contact microphone for musical instrument or vibration pick-up. Shipping Wgt. 1 lb. **\$1.00** each Extension cord with switch for above **\$.50** each

BC731 CONTROL BOX

with Weston Model 476 AC Voltmeter
NO. 208. Excellent buy in motor control box. Size 8"x10"x5 1/2". Contains Weston 0-150V. AC 3 1/2" voltmeter, motor starting switch, 28 fuses all 30 Amp 110V. and 8 fuse holders. Fuses and holders alone worth the price. Shipping Weight 18 lbs. **\$7.95**

METER SPECIAL

NO. 237. Brand new DeJur Model 312 0-800 M.A. D.C. Square 3" 0-10 M.A. basic meter with built in shunt. Probably the best buy ever offered in a surplus meter. **\$2.95** Shipping Weight 1 lb.

HEARING AID HEADPHONES

NO. 216. The Army's best - eliminate flat ears and outside noise. Complete with transformer for conversion from low to high impedance. With cord and plug complete. Add postage for 1 lb. **\$1.00**

BC 451 CONTROL BOX

NO. 236. Control box for 274N transmitters. Contains proper cwo-voice switch, 4 channel switch, power switch, mike jack and telegraph key. Add postage for 2 lbs. **\$1.95**

100 MA FILTER CHOKE

No. 641. Heavy 1.5 henry choke in drawn steel case, 50 ohm resistance, conservatively rated at 100 MA. Shipping Wt. 1 lb. **50c**

FILAMENT TRANSFORMER

No. 922. 220V. 60 cy. primary supplies 12.6V. at 3.5 Amps, 15.6V at 1 Amp. Supplies 6.3 at 3.5 Amps and 7.8V. at 1. Amp from 110V. Shipping Wt. 8 lbs. **\$1.50**

PANEL METER

Burlington O-300 VAC Meter
No. 290. Model 32XA 3 1/2" round AC Voltmeter 0-300 VAC full scale. Scale also calibrated 0-600V. Bakelite case. A beautiful meter in original carton. Shipping Wt. **\$3.95**

DRIVER TRANSFORMER

No. 651. Couples 3000 ohm plate to push pull parallel grids hermetically sealed. Ship. Wt. 1 lb. **\$1.00**

OUTPUT and MODULATION TRANSFORMER

No. 745. Companion transformer to above driver. A push pull output, 3000 ohms to 3.2 ohm voice coil, or to 1250 ohms at 80 MA. A high quality cased unit. Shipping Wt. 2 pounds. **\$1.00**

HOW TO ORDER . . . GIVE PART NUMBER AND DESCRIPTION . . . ADD POSTAGE FOR WEIGHT SHOWN. NO ORDERS UNDER \$2.00 . . . WE WILL SHIP C.O.D.

The HEATH COMPANY
... BENTON HARBOR 20, MICHIGAN

New Heathkit FM TUNER KIT



\$1475

CABINET EXTRA

A truly fine FM Tuner with the coils ready wound, all alignment completed — all that is necessary is wiring and it's ready to play — uses super regenerative circuit — 110 V. 60 cycle transformer operated — two gang tuning condenser — slide rule calibrated dial — two tubes — complete instructions including pictorial enable even beginners to build successfully. Shipping Wt. 4 pounds. Beautiful mahogany cabinet for FM Tuner (shown above) extra **\$3.75**

New

HEATHKITS and ACCESSORIES

Heathkit TUBE CHECKER KIT

Nothing ELSE TO BUY
Only \$29⁵⁰

Features

1. Measures each element individually.
2. Has gear driven roller chart.
3. Has lever switching for speed.
4. Complete range of filament voltages.
5. Checks every tube element.
6. Uses latest type lever switches.
7. Uses beautiful shatterproof full view meter.
8. Large size 11"x14"x4" complete.

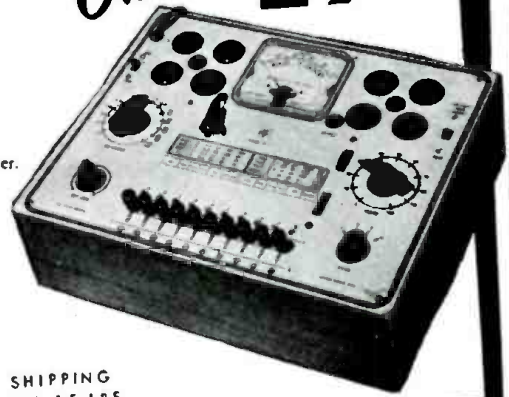

SHIPPING
WT. 15 LBS.

Check the features and you will realize that this Heathkit has all the features you want. Speed — simplicity — beauty — protection against obsolescence. The most modern type of tester — measures each element — beautiful Bad-Good scale, high quality meter — the best of parts — rugged oversize 110 V. 60 cycle power transformer — complete finest of Mallory switches — Centralab controls — quality wood cabinet — complete set of sockets for all type tubes including blank spare for future types — fast action gear driven roller chart uses brass gears to quickly locate and set up any type tube. Simplified switching cuts necessary time to minimum and saves valuable service time. Short and open element check. No matter what arrangement of tube elements, the Heathkit flexible switching arrangement easily handles it. Order your Heathkit Tube Checker today. See for yourself that Heath again saves you 1/3 and yet retains all the quality — this tube checker will pay for itself in a few weeks — better build it now. Complete with detail instructions — all parts — cabinet — roller chart — ready to wire up and operate.

New Heathkit

BATTERY ELIMINATOR KIT



\$22⁵⁰

SHIPPING WT. 18 LBS.

Now a bench 6 Volt power supply kit for all auto radio testing. Supplies 5-7 1/2 Volts at 10 Amperes continuous or 15 Amperes intermittent. A well filtered rugged power supply uses heavy duty selenium rectifier, choke input filter with 4,000 MFD of electrolytic filter. 0-15 Volt meter indicates output. Output variable in eight steps. Excellent for demonstrating auto radios. Ideal for servicing — can be lowered to find sticky vibrators or stepped up to equivalent of generator overload — easily constructed in less than two hours. Complete in every respect.

Nothing ELSE TO BUY

New Heathkit

BATTERY OPERATED VACUUM TUBE VOLTMETER KIT



\$34⁵⁰

SHIPPING WT. 12 LBS.

Nothing ELSE TO BUY

The famous Heathkit VTVM now in battery operated type. Use it anywhere — carry it out for work on auto radios — aircraft — boats — any place where 110 V. house current is not available — instant warmup — turn the switch and it's ready to operate. Same quality features, six linear D.C. ranges 0-3V.-10V.-30V.-100V.-300V.-1000V. High voltage extended to 10,000 Volts with probe listed below. Large 200 microampere meter with shatterproof plastic face. Ohmmeter measures from 1/10 ohm to one billion ohms with internal battery. 11 megohm input resistance on DC. AC is copper oxide rectifier type with ranges as above except no 3 Volt range. Complete with all parts, cabinet, 2 color panel, tubes, batteries, test prods and detailed instruction manual.

New Heathkit TOOL KIT

Now a complete tool kit to assemble your Heathkit. Consists of Krauter diagonal cutters and pointed nose assembly pliers, Xcelite screwdriver, 60 Watt 110 V. soldering iron and supply of solder. Shipping Wt., 2 lbs. Complete kit. **\$5.95**



RF Crystal Test Probe Kit
No. 309. Kit to assemble. RF probe extends VTVM range to 100 MC. Complete with IN34 crystal. Shipping weight, 1 lb. **\$6.50**

10,000 V M.V. Test Probe Kit
No. 310. Extends range of any 11 megohm VTVM to 3,000 and 10,000 Volt ranges. A necessity for television. Ship. wt., 1 lb. **\$4.50**



ORDER BLANK
HEATH COMPANY
BENTON HARBOR,
MICHIGAN

FROM _____

SHIP VIA
____ Parcel Post
____ Express
____ Freight
____ Best Way

Quan.	DESCRIPTION	Price	Total

Enclosed Find Check ... Money Order for _____ Please Ship C.O.D. ... Postage Enclosed for _____ lbs.



The HEATH COMPANY

... BENTON HARBOR 20, MICHIGAN

FOUND!

the "MISSING LINK" to
GOOD TV ANTENNA
INSTALLATIONS

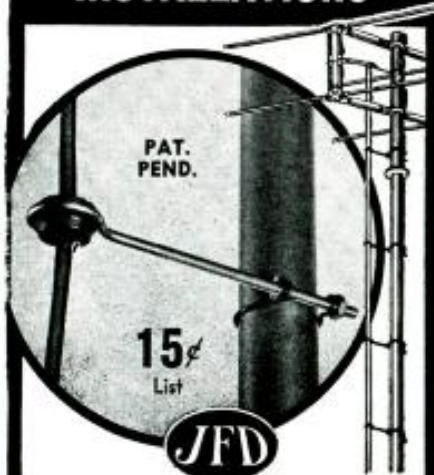

MAST CLAMP LEAD-IN SUPPORTS

Made with POLYETHYLENE
(the ultra-low loss insulation material)

Now you can make any old or new TV installation last longer, look neater, perform better with the unique JFD Mast-Clamp Lead-In Supports. These new Screw Eye Insulators are JFD-engineered to anchor lead-ins firmly in place and assure better TV/FM reception.



TL100-350
1" Clamp with 3/2" Screw
Eye for Twin Lead.

15c
List



RG100-350
1" Clamp with 3/2" Screw
Eye for Coaxial
Cable.

15c
List



DTL100-350
1" Clamp with 3/2" Screw
Eye for two Twin Leads.

35c List



DBR18TL3
3/2" Screw Eye with wood-
screw thread, for two Twin
Leads.

28c List

Mast Clamps are made in all sizes for all applications, individually designed to fit masts from 1/2" to 2" O.D. Screw Eyes range from 3 1/2" to 12" in length.

Visit JFD Booth 117 at
Chicago Trade Show in May

JFD MANUFACTURING CO. Inc.

6103 16th Avenue
Brooklyn 4, New York

WRITE TODAY
for Valuable 4-page Bulletin #DBR

© Copyright 1949 by JFD Mfg. Co. Inc.

FIRST In Television Antennas and Accessories

All rights reserved. No part of above work may be reproduced in any form except by written permission of the manufacturer.

Radio Manufacturers Association has submitted to the Federal Communications Commission a formal set of recommendations for an expanded television service for present owners of television receivers, with future supplemental high-frequency broadcasting for additional areas. The 12 v.h.f. broadcasting channels now in use would be utilized and expanded as far as possible under the RMA program and future (u.h.f.) service and stations would have a minimum of overlap of v.h.f. areas, the RMA committee said.

The RMA recommendations are:

1. Where practical without undue interference, utilize the 12 v.h.f. channels in those areas where stations are now operating or are under construction, and extend the use of these channels to other areas as soon as possible.
2. Utilize sufficient u.h.f. channels for monochrome television so that the cities capable of supporting television and not having any or adequate v.h.f. channels can have competitive service. In general, this would require a minimum of four stations per service area.
3. Arrange the assignments so that v.h.f. and u.h.f. coverage will have a minimum of overlap.
4. Release promptly a plan of allocation for the v.h.f. and allow this plan to be put into effect at once to permit the establishment of further v.h.f. stations even though the final allocation details for the u.h.f. assignment may not be complete at that time. The propagation data, including the advantages of synchronization, now available for the v.h.f. is adequate for preparation of such a v.h.f. allocation plan.
5. Provide that monochrome television in the u.h.f. channels shall use the same standards as those employed in the v.h.f. channels.

Radio Corporation of America announced a net profit of \$24,022,047 in 1948. This is equal to \$1.50 per common share, compared with a net profit of \$18,769,557, equal to \$1.12 per common share, in 1947, both after preferred dividends. The announcement was made in his annual report to stockholders by GENERAL DAVID SARNOFF, chairman of the board. Gross revenues in 1948 were \$357,617,231 against \$314,023,572 in 1947.

Oxford Electric Corporation of Chicago, maker of loudspeakers, announces that it has acquired a 50% interest in the Television Tube Research Laboratories of Clifton, N. J.

International Detrola Corporation reported to its shareholders a net profit of \$1,000,858 for the first quarter of 1949. Stockholders, at their annual meeting, voted to change the corporate name to Newport Steel Corporation. In announcing the net earnings of the company and subsidiaries for the three

months ended January 31, President C. RUSSELL FELDMANN compared them with net profit of \$1,710,083 for the full year ended October 31, 1948, and with a net profit of \$236,624 for the comparable quarter a year ago. The quarterly net profit equals 84 cents per share against \$1.40 for all of the previous year.

Quarterly sales were \$20,496,904 compared to \$69,314,489 for all of 1948 and \$18,312,613 for the comparable quarter of 1948.

Emerson Radio & Phonograph Corporation of New York reported net sales for the fiscal year ended October 31, 1948, of \$30,926,842, as compared with \$32,658,122 for the fiscal year of 1947.

The income of the company and its wholly owned subsidiaries for the fiscal year, before provision for federal income taxes, amounted to \$3,825,369 as compared with \$3,772,638 for 1947.

The Board of Governors of The Representatives, in preparation for the 1949 Radio Parts Manufacturers, Inc., trade show, held a special two-day meeting at the Stevens Hotel, Chicago, under the chairmanship of Irvin I. Aaron of Milwaukee. Other Board members present at the meeting were Samuel K. MacDonald of Philadelphia, Dan R. Bittan of New York City, and R. W. Farris of Kansas City, Missouri. National secretary-treasurer, L. C. McCarthy, was also on hand to give his preliminary report to the Board.

The Board unanimously approved a suggestion from the Industry Relations Committee that a Creed of Ethics be prepared and submitted for adoption by the entire organization at its annual delegates' meeting in Chicago, May 16. The Creed will establish national standards of practice and procedure for the first time in the history of The Representatives. It will also incorporate a summary of the principles and beliefs of members, all of whom are experienced sales representatives in the radio, electronic, and allied industries.

Stewart-Warner Electric of Chicago will introduce a 10-inch television set operating on d.c. only, in the New York market, thus eliminating use of an a.c. converter and also giving greater image stability. This was announced by E. L. TAYLOR, general sales manager.

Sonora Radio and Television Corp. of Chicago has filed a voluntary plan of reorganization in the U. S. District Court in Chicago. It is stated that the net worth of the company is \$300,000 while the claims of creditors are \$250,000.

Rauland-Borg Corp. of Chicago has purchased the sound division of the Rauland Corp. also of Chicago, now a wholly-owned subsidiary of Zenith Radio Corp.

The complete line of sound and amplifier products formerly manufactured by Rauland will be manufactured and sold by the new corporation.

RADIO-ELECTRONICS for

**SAVE
and Be
SAFE!**

**Buy Surplus & Standard Equipment
with money-back guarantee at**

**R & M
RADIO**

EXTRA TUNING UNITS

\$2.50 each, FOB, Kingman, Ariz., or Arlington, Va.

Types in stock: TU 5-7-8-9-10-26.

Typical components: 2 vernier dials; 1 var. cap., 20-135 mmf.; 1 var. cap., 20-156 mmf.; 1 var. cap., 8-26 mmf.—neutralizing; 1 .00003-2000V cap., CD—Mica; 3 .00009-3000V cap., CD—Mica; 2 .0004-5000V cap., CD—mica; 3 .0001-3000V cap., CD—Mica; 2 4-position ceramic band switches; 2 RF chokes; 1 tank coil—ceramic form with tapped ant. coupling coil; 1 tank coil—ceramic form; 1 parasitic suppressor; 2 ceramic flex. couplings; plus banana jacks, stand-off insulators.

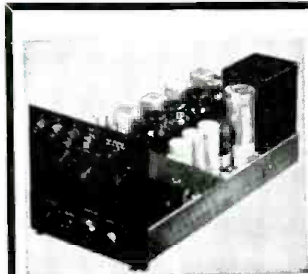

**APN-4 RCVR—'SCOPE
POWER SUPPLY**

4 switch-selected screw-driver tuned RF channels; IF freq. 1050 kc. band-width 45-60 kc; RF freq. 16 2000 kc. Tubes: (2) 2Y2, (3) 6B4, (4) 6SK7, (1) ea. 5U4, 6SU7, 6SA7, 6H6, VR150. Makes fixed tuner for med. freq. police calls or PA system. Has power supply for 5" scope, with 400 cycle trans. Electronic-controlled low v. supply; delivers 260 vdc. 150 mils reg. to .01%. Power supply alone worth **\$8.95** more than price.

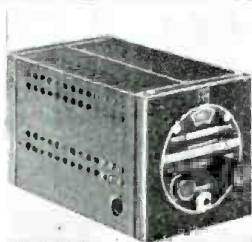

**BC 1206, LAZY Q FIVER
SINGLE SIGNAL
RECEPTION **\$9.95****

The littlest BIG BUY ever offered! A BC-1206 Satchell Carlson receiver will take the place of BC-453 (Lazy Q Fiver). We think it's even better. Here's why: Smaller—4" x 4" x 6 3/4"; weighs only 3 lb. 14 oz. Less current drain. .75 amps at 24 v. DC. IF freq. 135 kc. A conventional superhet circuit is employed and is arranged so that AVC will prevent overloading on strong signals.



**Buy it for conversion! Buy it to cannibalize!
Buy it to get on the air! It's the war-proved, versatile**

Complete with

- tuning unit (TU-6)
- antenna loading unit
- dynamotor
- set of plugs
- all tubes
- wiring diagram and conversion data free

BC-375-E

Quantity Limited

19.95

FOB KINGMAN, ARIZ.

Complete conversion diagram included. Xmtr. designed to operate from 200 kc to 12 mc (less BC band). Equipped with antenna tuning unit BC-306-A—variometer and tap switch. Dynamotor (PE-73-C) complete with relay, fuses and filter.

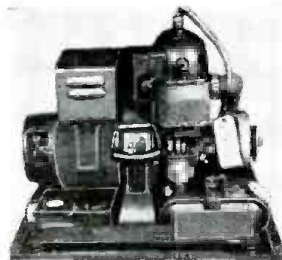

**The Famous PUTT-PUTT
Gasoline Generator (HRU-28)**

28 - 32
Volts D.C. **\$74.50**
ONLY

Single cylinder, 2-cycle gasoline engine with generator that is rated at 2,000 watts direct current. 70 amps. Has unlimited use around a farm; useful as field day power supply. More literature upon request.

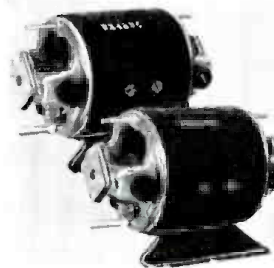

DUAL POWER SUPPLY

SAVE YOUR
BATTERY **\$4.95**
Both for \$8.95 each

Use our dual dynamotors by wiring them in series and use one on receivers and both in transmitter. High voltage output 600 volts at 48 watts. Low voltage 300 volts at 24 watts.

**INTER-
COM**



**Factory
Close-Out!**

**Brand New and Priced
for Quick Clearance!**

Limited **\$14.95**
Quantity

(List price \$34.95)

Price includes master station, one remote, and 50' of wire. Rig it up as a "baby-sitter" with pick-up at baby's crib. Useful in office, or for instant contact with basement, garage, attic, kitchen. Simple to install—just plug it in to 110 v. AC or DC socket.

TRANSFORMERS

For converting SCR-274-N to 115 Volts AC.

No. 1 Power Transformer. Pri—115v 60 cycle; sec—500 CT .06 Amp. 24v 1 1/2 amp. **\$3.90**
Price only

No. 2 Filament Transformer. Pri—115v 60 cycle; Sec. 1—14v 7 1/2 amp.; sec. 2 14v 7 1/2 amp. Series 28v 7 1/2 amp. Parallel 14v 15 amp. **\$4.50**
Price only

No. 3 Filament XMFR. Pri—115v 60 cycle; Sec. 24v 2 amps. **\$2.25**
Price only

**• Speakers—Brand New
Permanent Magnet**

4" **\$1.60**
5" **1.85**
12" Jensen in Metal Case **14.50**
10% discount, purchase of 2 or more

**Heavy Duty
Transmitting Chokes**

3 HY—500 MA—5000 V INS.
Price each **\$8.95**

• Condensers—Fixed

.05 Mfd. 600 Volts	\$0.15
10 Mfd. 500 Volts	.69
15 Mfd. 150 Volts	.69
16 x 16 450 Volts	1.20
20 250 Volts	.69
40 150 Volts	.75
50 150 Volts	.69
150 25 Volts	.54
200 10 Volts	.45
8 x 8 Can. Electrolytic	1.50

Tubes (New, in Original Cartons).

For the SCR-274-N Command Set & Others.

12A6	69c	ODR- VF150	75c
12SR7	69c	12SA7	69c
12K8	69c	77	59c
12SK7	69c	78	59c
12SF7	69c	89	59c
1625	89c	38322	\$1.19
1626	79c	12J5-GT	69c
1629	89c		

ALL EQUIPMENT F.O.B.

R & M RADIO COMPANY

2701 WILSON BLVD. DEPT. RE-59 ARLINGTON, VIRGINIA

• SAVE C.O.D. CHARGES and speed your order by remitting in full or 25% deposit. Please don't send money for postage, we ship "transportation charges collect." These prices supersede all previous prices. Write every month for BARGAIN BULLETIN.

Which Do You Want?



Better Pay



A Nice Home



A New Car



Greater Security



Happy Vacations and Travel

Get Your FCC Ticket
Jobs worth
\$3,000 to \$7,500
are opening up
right now for
FCC Licensed
Radiomen

Add Technical Training to Your Practical Experience and

Get Your FCC COMMERCIAL RADIO OPERATOR LICENSE in a Few Short Weeks



It's EASY if you use CIRE Simplified Training and Coaching AT HOME in SPARE TIME

Get your license easily and quickly and be ready for the \$3000 to \$7500 jobs that are open to ticket holders. CIRE training is the only planned course of coaching and training that leads directly to an FCC license.

YOUR FCC TICKET IS RECOGNIZED IN ALL RADIO FIELDS AS PROOF OF YOUR TECHNICAL ABILITY.

CIRE Graduates Find FCC License Pays Off

"Transmitter engineering is great, especially in the job I am on. Thanks again for all you have done, and you can take credit for the fact that my "ticket" is now posted on the wall of a 1000 watt broadcast station."

Student No. 3678N12

"I now hold ticket P-10-3787, and holding the license has helped me to obtain the type of job I've always dreamed of having. Yes, thanks to CIRE, I am now working for CAA as Radio Maintenance Technician, at a far better salary than I've ever had before. I am deeply grateful."

Student No. 3319N12

"I was issued license P-2-11188 on November 4. The next day I was signed on board a tanker as Radio Operator-Purser. Besides radio operating, I handle the payrolls, etc., which is all over-time and brings my monthly pay up to between \$500 and \$650."

Student No. 2355N12

CLEVELAND INSTITUTE OF RADIO ELECTRONICS
Desk RC-5, 4900 Euclid Building Cleveland 3, Ohio
Approved for Training under "G.I. Bill of Rights"

GET THIS AMAZING NEW BOOKLET

1. TELLS OF THOUSANDS OF BRAND-NEW, BETTER-PAYING RADIO JOBS NOW OPEN TO FCC LICENSE HOLDERS.
2. TELLS HOW YOU WILL BENEFIT BY HOLDING AN FCC COMMERCIAL LICENSE.
3. TELLS HOW YOU CAN GET YOUR FCC COMMERCIAL RADIO OPERATOR LICENSE IN A FEW SHORT WEEKS—EASILY AND QUICKLY, BY USING CIRE SIMPLIFIED TRAINING AND COACHING AT HOME IN YOUR SPARE TIME.
4. TELLS OF HUNDREDS OF OUR SUCCESSFUL STUDENTS WHO NOW HAVE LICENSES AND NEW, BETTER-PAYING JOBS.
5. TELLS HOW WE PREPARE YOU TO PASS THE NEW FCC COMMERCIAL LICENSE EXAMINATIONS, WHICH NOW INCLUDE FM AND TELEVISION.
6. TELLS HOW WE GUARANTEE TO TRAIN AND COACH YOU UNTIL YOU GET YOUR LICENSE.
7. TELLS HOW WE HELP YOU TO GET A BETTER-PAYING, LICENSED JOB, WITH OUR FREE AND EXCLUSIVE SERVICE, WHICH PREPARES YOUR EMPLOYMENT APPLICATION FOR MAILING TO HUNDREDS OF EMPLOYERS, INCLUDING FM, AM AND TELEVISION BROADCAST STATIONS, RADIO MANUFACTURERS, POLICE RADIO STATIONS, AND RADIO-EQUIPPED TAXI, BUS AND PUBLIC UTILITY COMPANIES.



Get All 3 FREE Send Coupon Now!

CLEVELAND INSTITUTE OF RADIO ELECTRONICS
DESK RC-5, 4900 Euclid Bldg., Cleveland 3, Ohio
(Address to Desk No. to avoid delay)

I want to know how I can get my FCC ticket in a few short weeks by training at home in spare time. Send me your FREE booklet "Money Making FCC License Information", as well as a sample FCC-type exam and free booklet, "How to Pass FCC License Examination", (does not cover exams for Amateur License).

Name _____
 Address _____
 City _____ Zone _____ State _____

____ Veterans check for enrollment information under G. I. Bill.
NO OBLIGATION—NO SALESMEN

The Radio Technician

. . . Good days are ahead for the radio servicing trade . . .

By HUGO GERNSBACK

SINCE 1929—for just 20 years—this magazine has conscientiously endeavored to serve the radio service technician. It will continue to do so in the future.

But as radio continued to change, so did the radio technician. In 1925 the man with a screwdriver and a pair of pliers had no particular difficulty in servicing radio sets. But as radio receivers became more complex every month, the service technician had to change as well. Servicing instruments came into wide vogue in the 30's, and their complexity increased to keep pace with the ever-changing radio picture.

Today—with television booming beyond our fondest expectation—the oldtime "serviceman" no longer can cope with the complexity of these new televisers.

Besides being a radio man he now also must be a television man, and if he has not had experience with television it means that he must learn the subject from the ground up.

For this reason and many others, it has been decided by RADIO-ELECTRONICS that beginning with this issue the old term "serviceman" be discontinued entirely, using in its place the more modern and appropriate term "radio technician."

RADIO-ELECTRONICS did not originate this term. It has been used in the radio manufacturing trade consistently for some time. We feel certain that the new—and better—term will enhance the standing of the present-day service technician a good deal in his community.

To borrow a very apt expression of Max F. Balcom, President of the Radio Manufacturers Association, in a recent talk:

"It means that the radio technician will be working on a much more costly product (televisers) than he has been in the radio field. . . . *It is like turning from repairing bicycles to servicing automobiles.*" The italics are ours.

With television now firmly established it would seem that great and profitable days are ahead for the servicing trade. Indeed it will be a small miracle if there can possibly be enough radio technicians to service all the new televisers by 1952. Here is the reason we see it that way:

There are now approximately 75,000 established radio technicians in this country. In many localities they have difficulty in servicing the 67 million radio sets now in use, *plus the over two million television sets* already installed. By the end of this year there will be at least three million television receivers in use. By the beginning of 1952, it is not only possible but very probable that there will be

between 12 and 15 million televisers in the public's hands.

Unless there is a steady influx of new radio technicians, who is going to service all of these receivers?

What is needed at the present time—needed desperately—are trained—really trained—radio technicians who know television from A to Z. Look into any newspaper in the country where television programs are now being broadcast and note the help-wanted advertisements. These advertisements show that there is, even now, *a scarcity of good radio technicians who know their business.* This situation is certain to become more acute as time goes on.

The radio and television set manufacturers are fully aware of this situation and are now taking active steps to promote service meetings for radio technicians all over the country. They, however, deplore the fact that they are meeting with resistance and indifference from many radio technicians who do not attend these meetings in force. Regardless of who the manufacturer is, the service technician can gain a tremendous amount of knowledge by attending these meetings as they take place. No matter how busy he is, he should find time to attend these meetings which are now increasing rapidly in number all over the land.

Service technicians must follow certain routines in servicing televisers. These routines save a great deal of time. In other words, it is the old "know how." All these points are discussed in great detail at these service meetings, and any radio technician—no matter how good his knowledge—can enhance his standing by attending them. *They cost him nothing except his time.*

Another important matter that should be mentioned here is the following:

According to a countrywide survey made by the Broadcast Measurement Bureau, there were early this year 5,177,100 radios in the U. S. not in operating condition. That is a lot of receivers.

What have the radio technicians done to obtain this lucrative business now lying dormant? Apparently nothing.

Several radio manufacturers have investigated this condition and are ready to give the radio service technician not only hints, but also advertising suggestions that can be used locally to induce the owners of these old receivers to have them repaired and put into use again.

There is little question in our mind that there will be an extended radio servicing boom in the very near future. Are you ready for it?

Announcing

\$100 PRIZE CONTEST

TELEVISION receivers can be made simpler. The number of tubes used in a modern televisor is reminiscent of the number of controls on broadcast receivers in the early '20's, when some of the best sets had close to a dozen knobs and dials.

The problems of simplification are complex, and well worth the attention of the most advanced experimenters in the art. To stimulate interest in this project, RADIO-ELECTRONICS is publishing below a description of a successful French televisor which uses only eight tubes besides the cathode-ray tube.

RADIO-ELECTRONICS now offers a cash prize of \$100 for the best simple American televisor to be constructed under the following rules:

1. No fixed number of tubes is prescribed; but because the prize contest stresses simplicity, the receiver which uses the fewest number of tubes to accomplish given results will be rated highest. Televisors with more than 12 tubes (excluding rectifiers) will not be considered in this contest.

The cathode-ray tube and rectifier tubes (or selenium rectifiers) will not be considered tubes for the purpose of this count, but any crystal diode used in detector, limiter, and other circuits where a tube is commonly employed will be counted as half a tube.

2. Only photographs and description of the televisor are to be sent to RADIO-ELECTRONICS. If the editors wish to inspect the set, they will request it. Express charges both ways will then be paid by RADIO-ELECTRONICS.

3. To make construction simpler, and to focus attention on the main problem of simplification, it is not necessary that the televisor cover both television bands. A set which covers one band only will be judged against its competitors on the same band.

However, since the American tradition (unlike the European) has been to have the sound and vision receivers in one unit, *all receivers submitted must be capable of receiving both television sight and sound.* Loud-speaker results are not necessary; headphone output may be used.

4. All descriptions and photographs of the winning receiver will become the property of

RADIO-ELECTRONICS, which will publish a descriptive article on the set at regular space rates. The set itself will remain the property of the builder.

5. If two or more televisors are judged worthy of a prize, identical \$100 awards will be made for all accepted entries.

6. As it is the purpose of this contest to stimulate actual building of a special televisor, mere ideas and proposals, special circuit diagrams, patents, etc., are excluded from this contest.

7. Excluded from this contest are all employees of RADIO-ELECTRONICS and their relatives.

8. This contest closes at noon, September 1, 1949 (Eastern Standard Time), at which time all entries must have been submitted to RADIO-ELECTRONICS.

9. The judges of this contest will be the Editors of RADIO-ELECTRONICS and their findings will be final.

10. Announcement of the prize awards will be made in the January, 1950, issue of RADIO-ELECTRONICS. The prize or prizes will be paid on the publication date of the January issue of RADIO-ELECTRONICS.

Eight-Tube Televisor

THE construction of a television receiver is said to require time, a calibrated signal generator, and plenty of money, declares a writer in a recent French radio magazine. But he believes—and has constructed a televisor to prove his belief—that a set that does not cost an unreasonable sum can be built, and that its construction is not especially difficult.

The total number of tubes in the set, built by Pierre Roques—the French engineer who set out to prove that television sets can be simple—is eight! With this small number of tubes, the quality of pictorial reception is excellent, stability is satisfactory, and the sensitivity such as to receive transmissions from the Paris station in all parts of that city with an ordinary dipole antenna. The sole drawback, according to the constructor of this unique televisor, is the small image size. The tube is the equivalent of the American 3-inch size. The set does not have a sound channel.

While there are many differences be-

tween American and French television problems, notably the positive transmission and the fact that there is only one French station on the air, the Editors of RADIO-ELECTRONICS feel that there is much worthy of study in this simplified television circuit, and it is therefore reproduced below.

French television receiver

The televisor has eight tubes (plus the cathode-ray tube) which have the following functions:

1. A radio-frequency amplifier using two high-transconductance tubes, type EF51;
2. A detector using half of a 6H6;
3. A video frequency stage using an EF51;
4. A sync separator stage using the other half of the 6H6;
5. A line sweep comprising a triode-pentode ECF1 as multivibrator and half a 6N7 as a sweep amplifier;

6. A frame sweep using the other half of the 6N7 as a blocking oscillator synchronized by the 50-cycle line;
7. A low-voltage supply (300 volts) with a 5Y3-GB;
8. A high-voltage supply (1,000 volts) using a 6H6 as a voltage doubler;
9. A 7.5-centimeter (3-inch) cathode-ray tube.

The r.f. amplifier

The hookup of this section is very standard. The input circuit is designed to match a 72-ohm co-axial cable. The gain (contrast) control is the 5,000-ohm, wire-wound potentiometer P1, which varies the bias of the first r.f. tube.

Detection

The winding L4 inputs to the cathode of the 6H6, and the detected video signal appears between its plate and

Schematic of the French experimental television receiver which obtains excellent results with eight tubes (plus cathode-ray tube).

ground. This is applied to the video-frequency stage through a resistance of 500 ohms, which, with the input capacitance of the video tube, forms a filter which removes any residual radio frequency.

Video-frequency amplifier

Again we have a standard schematic. A high-frequency compensation coil is not used; with the small picture tube it is not necessary to amplify a wide band of frequencies.

The amplified video-frequency signal is then applied to the cathode-ray-tube control grid through a 0.1- μ f capacitor of very high quality (1,500-volt test at least) and through another capacitor of the same quality to the sync separator half of the 6H6.

Sync separation

The signal on the cathode of the 6H6 is such that the sync pulses go negative and the video-frequency signals go positive. Thus no current passes through the diode except during synchronization. We find, then, at the plate negative pips which are sent on to the multivibrator.

To improve the output of this separator stage, the 6H6 plate is given a slight positive polarization.

Line sweep

The ECF1 is hooked up as a cathode-coupled multivibrator. The frequency is controlled by the 500,000-ohm potentiometer P2. The amplitude can be controlled by changing the resistance of the resistor shown as 100,000 ohms in the plate lead of the triode section.

A capacitance-type voltage divider (.0005 and .01 μ f) permits obtaining the necessary voltage to apply to the

sweep amplifier (one-half of a 6N7). The high grid resistance of this tube permits automatic biasing by inserting resistance in the cathode. The gain of the amplifier is controlled by adjusting the plate resistor (20,000 ohms) to a suitable value (see "Putting into Operation").

The cathode-ray-tube deflection plate D1 is connected to the plate of the triode section of the ECF1 through a capacitor of .005 μ f. The plate D2 is also connected to the 6N7 plate through a capacitor of the same value.

Frame sweep

The second half of the 6N7 is hooked up as a blocking oscillator. The transformer has the following characteristics:

- Secondary: 1,000 turns No. 30 enamel
- Primary: 500 turns No. 30 enamel
- Core: 2 x 4 centimeters square (small filter choke or loudspeaker transformer).

The frequency is controlled by the 1-megohm potentiometer P3. Synchronization is effected by bringing the transformer to chassis through the intermediary of a resistance bridge connected between the filament (6.3 volts) and chassis. It is put into phase by varying the frequency potentiometer slightly, once it has been adjusted to 50 cycles per second.

The sweep amplitude is regulated by changing the value of the resistor (shown as 1 megohm) in the 6N7 plate. The sawtooth waves obtained are applied to the deflection plate D2 through a .01- μ f mica condenser.

Medium-tension supply

An indirect heater tube 5Y3-GB is used, with a 300-0-300-volt transformer

feeding its plates. The center point is returned to the chassis through a resistance of 300 ohms, thus supplying a voltage of -20 for the brightness control.

High-tension supply (1,000 volts)

The transformer has an output of 450 volts which is supplied to the 6H6, connected as voltage doubler. The rectified voltage of 900 is connected in series with the medium voltage supply of 300 volts, providing 1,200 volts. After filtering through the 100,000-ohm resistor, about 1,000 volts remains. The multivibrator and blocking oscillators are also supplied with this voltage.

Cathode-ray tube

A Philips tube of 7.5-cm diameter (DG 7) with green phosphor, its characteristics are:

- Filament: 4 volts, 1 ampere
- Second anode: 600 volts
- First anode: 150-200 volts, variable (focusing)

Control grid: variable, never positive (brightness).

The second anode voltage is obtained with a voltage divider which serves the vertical and horizontal hold-control system at the same time (P6 and P7 are two 2-megohm potentiometers). The focusing control is the potentiometer P4 (100,000 ohms) and the brightness control is P5 (100,000 ohms with switch), the switch being the on-off switch of the set.

Putting into operation

Putting the r.f. section into operation is a quick process. All that is needed, after checking the wiring and the voltages, is to attach the antenna.

If the windings are correct, images

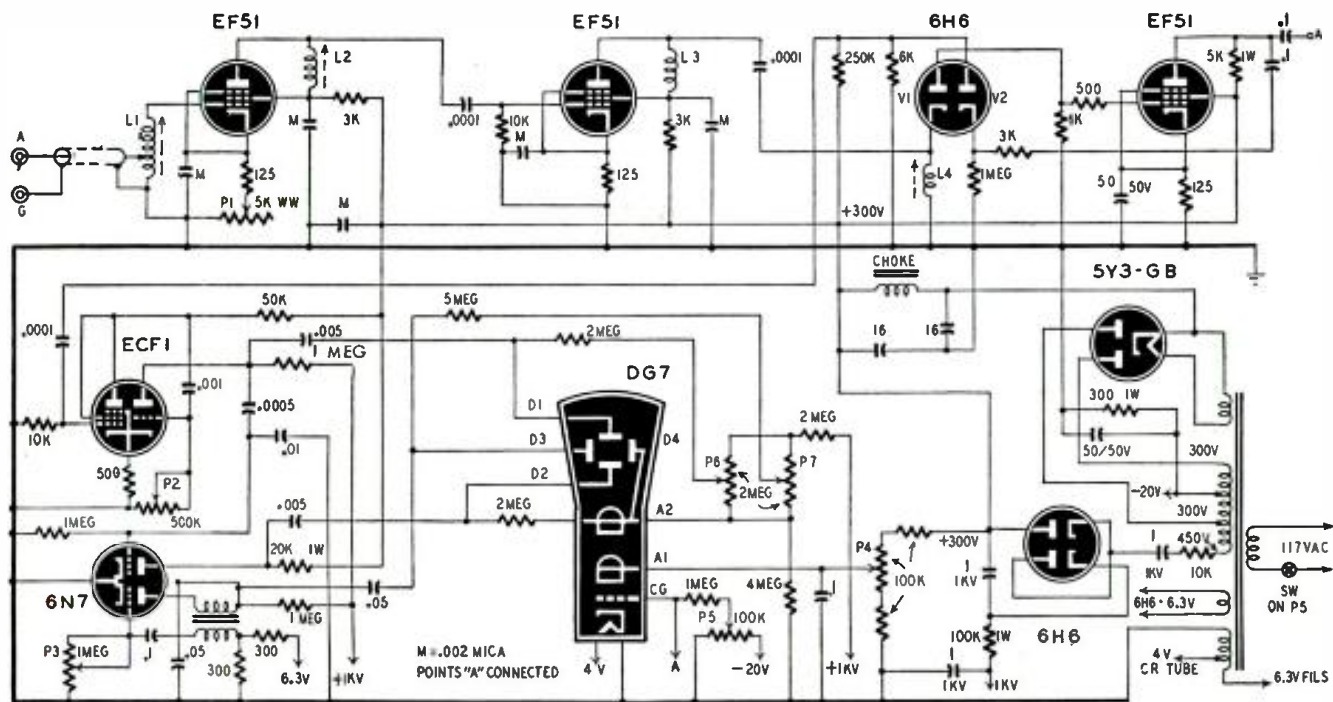

should be received immediately (check with an oscilloscope connected to the control grid, for preference). Then adjust the cores of the r.f. coils for maximum reception, with potentiometer P1 in the position of maximum gain (shorted).

Flashes may then be seen in all directions on the tube screen. Working with the potentiometers P2 and P3 brings out the image and stabilizes it. The dimensions are regulated as follows:

1. Vertically (frame): Change the 1-megohm resistor in the 6N7 plate circuit.

2. Horizontally (line): Disconnect the capacitor in the D2 circuit and bring the sweep to half the desired dimension by changing the 1-megohm resistor in the ECF1 triode circuit. Reconnect the capacitor and adjust the 20,000-ohm resistor in the 6N7 plate circuit until the normal size is obtained.

The antenna recommended is a doublet with unbalanced lead-in. The co-ax should have an impedance of about 75 ohms.

Here, to conclude, are the power transformer specifications:

Primary: 110 volts, 0.5 ampere

Sec. 1: 5 volts, 2 amperes

Sec. 2: 300-300-450 volts (100 ma)

Sec. 3: 6.3 volts, 0.3 ampere (for 6H6 doubler)

Sec. 4: 6.3 volts, tapped at 4 volts, 3 amperes (filaments, including DG7).

Changes for U. S. standards

A few modifications may permit this circuit to be used as the basis for an experimental video receiver for use in this country. The first step is to revise the t.r.f. circuit. The EF51 is a variable- μ pentode designed for high-frequency service. This tube has a transconductance of 9,500 micromhos. No American tube can be used as a direct replacement, but the circuit can be modified to fit a number of our tubes. A 6AC7 can

be used in this circuit (with a 300-volt B-supply) if a dropping resistor is used to limit the screen voltage to 150 when the plate is drawing 10 ma at 300 volts. This resistor will be in the order of 60,000 ohms. The cathode biasing resistor should be about 160 ohms, and the suppressor should be grounded directly to avoid instability and feedback. (For high-band use, a 6AK5 might give more gain than a 6AC7.) Coils L1-L4 for low band may be air-wound with about 3 turns of No. 14 wire with an inside diameter of $\frac{1}{2}$ inch. The spacing between turns should be adjusted so the coils cover the desired range when tuned with 5-50- $\mu\mu\text{f}$, miniature air trimmers. The location of the antenna tap on L1 should be found by experiment. Commercial permeability-tuned coils such as the National AR-2 and AR-5 may be used.

The video detector V1, one half of the 6H6, develops a positive-phase output signal. This signal is reversed 180 degrees in its passage through the EF51 video amplifier. If this signal is applied to the grid of the C-R tube, the image will look like a photographic negative (the dark areas will be light and the light ones dark). This can be avoided by using two video amplifiers in cascade instead of a single stage. The same results can be obtained by reversing the connections to the video detector plate and cathode, though the first method has the advantage of providing extra amplification. The picture phase at the input of the sync clipper should be opposite to that at the input to the grid of the C-R tube, so the connections to the plate and cathode of V2 will also have to be reversed.

The ECF1 is a variable- μ pentode and triode similar to the 6F7 or 6P7. The pentode section of this tube is operated as a triode; therefore any number of dual triodes may be made to work equally well. The constants of the differentiating circuit, 10,000-ohm grid resis-

tor, and .001- μf coupling capacitor may have to be juggled to provide proper separation of the horizontal sync pulses so they can control the horizontal multivibrator. Remember that the resistor in the differentiator circuit is also the grid leak of one section of the multivibrator.

The design data for the blocking transformer may prove suitable for constructing a unit to work at 60-cycles. However, it will probably be best to use a commercial vertical blocking transformer since they are available for less than \$2.50.

The high-voltage power supply will depend on the C-R tube used. Such tubes as the 2AP1, 3BP1, 3EP1, 3KP4, etc., can be used. It is doubtful that the average builder will find a power transformer like the one shown in the diagram, but it is possible to connect the voltage doubler to one of the plates of the low-voltage rectifier rather than to a tap on the winding. A number of surplus radar and oscilloscope transformers are available and the experimenter will be able to find one of these to suit his needs. A small replacement power transformer may be used. One side of its high-voltage secondary may be grounded and the other end connected to the plate of a rectifier tube. The positive high voltage may be taken off its filament or cathode.

It may be necessary to bypass the r.f. amplifier filaments to ground with .0005- $\mu\mu\text{f}$ mica or ceramic capacitors and to insert small u.h.f. chokes in the hot leads. These chokes may consist of 20-25 turns of No. 22 enamel wire wound on a 1-megohm, 1-watt resistor or other suitable form.

The 5Y3-GB is a Mazda tube directly replaceable, in this circuit, by a 5Y3-G or 5Y3-GT. Any rectifier tube having similar characteristics can be used.

This article, up to "Changes for U.S. Standards," was based on a translation of an article in the December 1948 issue of *T.S.F. pour Tous* (Paris).

BRIGHTER TELE IMAGES NOT ALWAYS BETTER

The answer to better video images is not to be found in merely increasing the brightness of the image, it was indicated by a paper presented at the Winter General Meeting of the American Institute of Electrical Engineers in New York, by Dr. P. C. Goldmark of the Columbia Broadcasting System.

Reporting on research into brightness and contrast in television, Dr. Goldmark said, "Contrast range is more important than mere brilliance, and contrast at moderate brightness is far more important to the eye than brightness applied indiscriminately. Increased brightness is of use to the eye only if it brings with it increased contrast."

"It is this increased contrast which assists the eye to see fine detail. If one wishes to see greater detail in a picture, one may increase the contrast, if possible, or move closer to it for a more detailed examination. The limit is set by the maximum possible picture brightness and the eye's resolving power.

"Several inherent properties of television make it difficult either to increase the brightness or view the picture from a closer range. The most basic limitation is that television's pictures are made up at approximately 500 horizontal scanning lines. Each line can show no detail along its height, but can show variations along its length. No matter how closely one looks at a television screen, or how bright it is, no detail smaller than a square area whose height is roughly that of a line can be perceived.

"One of the proposed solutions for producing adequate contrast range in television pictures suggested increasing the picture highlight brightness to a value many times above that of the surrounding brightness. This solution does not solve the problem because local illumination which is much higher than the general ambient illumination produces a sensation of glare, and glare reduces visual effectiveness. Experi-

ments with visual acuity and with contrast recognition have shown that both reach their optimum for a given brightness when the surrounding illumination is about the same as the locally illuminated area.

"Many present day receivers," said Dr. Goldmark, "should not be viewed in rooms where the surrounding illumination is much in excess of 1 foot-lambert, otherwise the picture will suffer from inadequate contrast range. It is conceivable that commercially competitive direct-view receivers will some day be capable of furnishing a high-light brightness of 450 foot-lamberts. It is doubtful, however, that this would be a satisfactory solution, since viewing such a bright image without a correspondingly bright surrounding would be uncomfortable. Assuming that the presently used field repetition rate of 60 per second were employed, such a picture would also display objectionable flicker."

TELEVISION'S TRENDS

By DR. LEE deFOREST

THE first question I meet everywhere is: Do present tendencies indicate a material and permanent drop in receiver prices?

No marked falling off in the general price level need be expected so long as the present demand continues. As each new TV transmitter goes into operation, a new audience arises, of a size proportionate to that of the city or district involved. Until every town in the nation of 50,000 or more has its transmitter, any approach to saturation, with a resultant falling off of receiver demand, is most unlikely. Such considerations seem to postpone any very great price reduction for a long time to come.

Naturally the 7-inch and 3-inch sets will be even cheaper than they are today, because the relative merits of the 12-inch and 16-inch tubes are so convincing that the demand for the smaller sets, even with prices reduced, will diminish. And until the projection set has been materially improved, the brilliant, direct-view, large-tube set will continue in top demand.

We need not apprehend any changes from present RMA TV standards for a long time to come, such as may be required for the yet ill-explored u.h.f. bands. The industry today is too firmly founded, the television audiences already too vast and ever growing to permit the FCC to recommend or impose confusions of that nature.

This argues against expecting any radical changes in circuits. Simplified printed-circuit elements may be expected, and will somewhat reduce labor costs and speed up production. Multi-unit chassis will simplify service.

I think we shall see, ere long, rectangular, metal, pyramidal tube structures, involving, incidentally, a flatter glass screen surface. Without doubt, tube makers will solve the (apparently) difficult problem of the glass-metal rounded-corner seals which today are unsure against crack-strains. Such a tube, of 16 × 12-inch dimensions, giving us approximately 190 square inches of brilliant picture, and avoiding all huddling, should prove ideal.

For theater television, the FCC has found no specific place in the spectrum, but will give co-operative consideration to applications for experimental research involving intracity transmissions on frequencies between 480 and 920 mc, an allocation however, which can "be discontinued when needed for broadcasting!" In addition, experimentation with intra- and intercity relay of theater television programs may be authorized on six hyper-high bands, extending



TV set is focal point of many present-day living rooms, will appear in most in the future.

from 1,900 to 30,000 megacycles. Here, surely, is abundant opportunity for endless experimentation, with microwaves from 19 to 3 centimeters—not to mention the intricacy possibilities of infra-red or ultra-violet light transmissions *without* consent of the FCC.

It is clear that theater television in general will have no rosy path of progress, beset as it will be by unsolved problems of desirable tele programs, split-second time schedules, as well as mighty tough engineering. One basic change will be requisite: to double at least the present number of picture lines. A 525-line picture when blown up even to 18 × 12 feet resembles too unpleasantly a peepshow through a Venetian blind.

And after all, save for outstanding athletic events or a presidential inauguration (which we can all see in our homes), why should television attempt to compete with photographic projections which will always be inherently far superior? This talk of supplementing theater film reels by broadcast television pictures is the veriest twaddle, a fatuous dream.

In closing, a word regarding color. Elaborate and exceedingly costly experimentation, notably by CBS and

RCA, has demonstrated that, given sufficiently high-frequency carriers and adequately wide video bands, good natural-color subjects can be transmitted. The appeal of such pictures in comparison to black and white is as compelling, as exciting, as that witnessed today in every cinema when a technicolor film is shown.

Unquestionably, therefore, we shall have color television. How soon is anyone's guess. Certainly not in two years, perhaps five. Whether this will be by so-called mechanical methods or "all-electronic" is still debatable. My own current experiments along these lines, while as yet not sufficiently far advanced to be definitely conclusive, give encouragement to the prospect of three-color-transmission *using our present black-and-white frequencies*. As of today, therefore, I see no necessity for restricting color to the u.h.f. ranges, with all the uncertainties involved—short transmission range, multiplied ghosts, obstructions, signal inaccessibilities, and so on.

Certain it is that the future, immediate and remote, of television is unlimited, eventful beyond our present imagination—and *glorious*, if we care to build it so.

All Channel TV Tuner

A TV front end can be constructed without any of the usual specially made coil or bandswitch assemblies

By E. J. SCHULTZ

ALTHOUGH there are a number of good television receiver kits and components available on the market, there are numerous constructors who, like the author, take pride in constructing their equipment without using manufactured assemblies. The average constructor will find that design and construction data on video i.f. amplifiers, detectors, sweep circuits, and video amplifiers have been published in a number of technical magazines and papers. Unfortunately, for us, little or no material is available on constructing or designing a TV front end for all channels. A number of commercial tuners have been described, but all these rely on special switches, turrets, or other components not readily available to the ordinary radio constructor.

Tuners usually present two problems: one is to make the oscillator work over the entire range, and the other is to track the mixer and antenna stages once the oscillator is working properly. The tuner described here was developed after weeks of experimenting with all types of circuits. Simple, it can be duplicated by almost anyone experienced with high-frequency circuits. It uses a channel-switching tuning system that

can be made to work into almost any existing video i.f. circuit. It will work nicely with the video i.f. amplifier described on page 110 of the March, 1949, issue.

The circuit consists of a 6J6 broadband, grounded-grid amplifier with a cathode coil that is broadly resonant over the entire TV band. Its input circuit has an impedance of approximately 300 ohms on all TV channels. The plate circuit of the 6J6 is tuned and capacitance-coupled to the grid of the 6AG5 mixer. The oscillator is a 6C4 with its grid circuit tuned above the signal frequency and its cathode circuit loaded with an inductance. The plate is at ground potential for r.f. The oscillator and mixer grids are coupled to each other through stray capacitance and inductance.

The channels are selected with a 2-circuit, wafer-type rotary switch. One wafer switches small preset trimmer capacitors across the coil in the plate circuit of the 6J6, and the other shunts the oscillator coil with preset trimmers or small inductors. The capacitors lower the resonant frequency of L4 and the inductors raise it. Switch-tuning is advantageous in that it permits each channel to be aligned without disturbing the

settings for other channels. A 2-plate midget and a 10- μ f capacitor are in series across the oscillator coil for fine tuning.

Construction

The channel-selector switch should be well constructed with good high-frequency insulation and good, clean, low-resistance contacts. A 7-position switch was selected for channel-switching since this is the maximum number of channels that will be assigned in any one area. If a builder is midway between the primary service areas of stations in two cities, a switch with more positions can be used. The position of the components is shown in the photographs. The oscillator grid and 6J6 plate circuits should be as close to the switch as components permit. In cases where leads must be long, make them out of heavy wire, as is usual in v.h.f. work.

The under-chassis photograph shows placement of the parts in the tuner circuit. The oscillator socket is hidden by components mounted on its terminals. It is mounted just back of the 2-plate midget capacitor used for fine tuning. The oscillator grid coil, L4, is the large one between L8 and L9. The shunt inductors L5, L6, and L7 are mounted directly on the channel-selector switch. L3, the tuned coil between the amplifier plate and mixer grid, is the heavy winding close to the antenna coil. Circuit operation may possibly be improved by locating this coil at the socket of the 6AG5.

L1 has 6 turns interwound with L2, which has 12 turns on a $\frac{3}{8}$ -inch form. Both coils are closewound with No. 32 s.s.e. wire. L3 has 3½ turns of No. 14 enamel wound with an inside diameter of $\frac{1}{2}$ inch and spaced to 1 inch long. The oscillator coil L4 consists of 2½ turns of No. 14 enamel wire spaced to $\frac{1}{2}$ inch with a $\frac{1}{2}$ -inch inside diameter. L5, L6, and L7, the shunting inductors, are for channels 7, 11, and 13, respectively. They are self-supporting coils wound with No. 20 enamel wire to a $\frac{1}{4}$ -inch inside diameter. L5 has 5 turns spaced to $\frac{1}{2}$ inch, L6 has 3 turns spaced to $\frac{3}{8}$ inch, and L7 has 2 turns spaced to $\frac{1}{2}$ inch. L8 is a self-supporting coil made from 25 turns of No. 20 enamel wire close-wound on a $\frac{1}{4}$ -inch form. L9

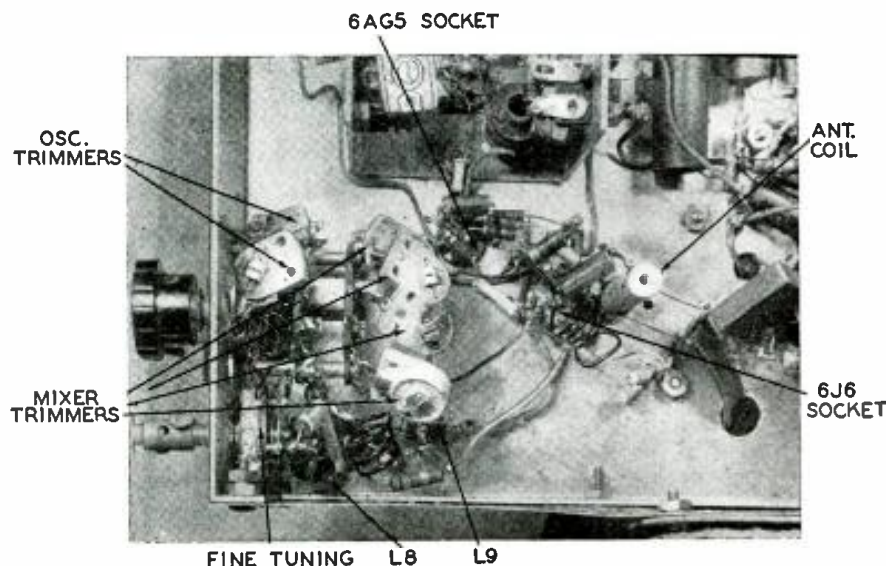

The parts are assembled in a compact mass under the chassis to eliminate long-lead trouble.

is 30 turns of No. 30 enamel wire close-wound on a $\frac{3}{16}$ -inch form. The specifications for L5, L6, and L7 are approximate. The exact number of turns and spacing will have to be determined for each individual layout. Coils can be wound for other channels by using cut-and-try procedure based on the data which has been given for channels near them.

Aligning the tuner

The tuner should be completed and connected to the i.f. system of a receiver before beginning the alignment procedure. Cut-and-try adjustments can be minimized by calculating the lowest oscillator frequency and adjusting L4 to approximately this frequency with an absorption frequency meter. The oscillator operates *above* the signal frequency, so its frequency can be found by adding the sound i.f. to the sound carrier frequency or by adding the video i.f. to the video carrier frequency.

The tuner can be aligned on a television signal or with an accurate signal generator. Set the channel-selector switch to the channel to be tuned in. Adjust the appropriate oscillator trimmer so the sound and picture come in together. Adjust the mixer trimmer for the best compromise between picture quality and maximum volume. If a high-band channel is being aligned, resonate the oscillator by varying the spacing between the turns of the shunt inductors. A tuning wand is useful in this operation because it indicates whether the turns should be squeezed together or spread apart. The vernier tuning control should be set at its mid-point when aligning each channel.

If it is impossible to peak the mixer coil on the highest channel, its trimmer may be replaced by a parallel inductor similar to the ones in the oscillator circuit.

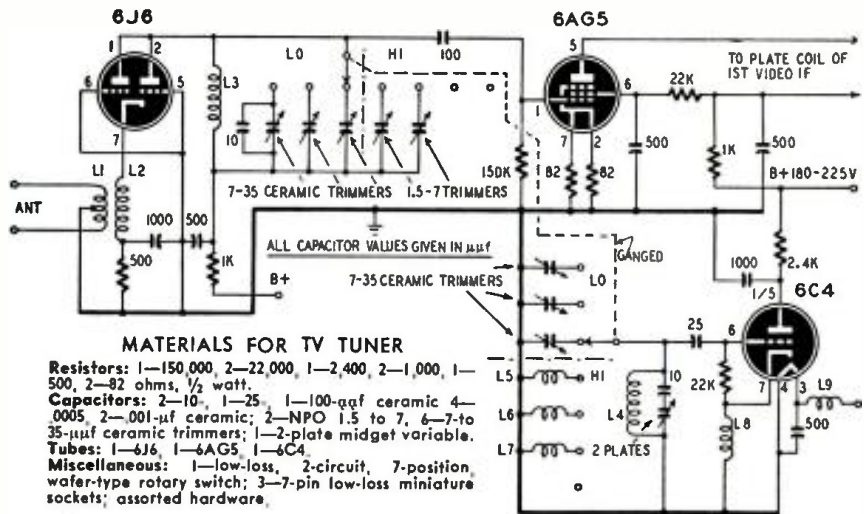

The tuner precedes a 3-stage video i.f. amplifier followed by a detector and video amplifier driving a 7-inch picture tube. The set receives all New York City channels with satisfactory signal strength and picture quality when using an indoor antenna at Bayside, Long

Island, approximately 15 miles from the stations.

Although not the ultimate in design, this tuner gives good results and will serve as a foundation for those constructors who design and build their own television receivers.

TELEVISION NOTES OF THE MONTH

Channels for TV may number 50 to 70 if a u.h.f. band is adopted, FCC chairman Wayne Coy told a group of radio and advertising executives recently. "I hold the need [for additional channels] to be self-evident," Mr. Coy said in a speech in Boston. "How many channels it takes to satisfy that need I do not know. My present thinking is that 50 to 70 channels may be required." Adding his own predictions to those current recently about the fight for audiences between radio and television, Mr. Coy said, "As I see it, broadcasters who own television stations will gradually dispose of their radio stations and concentrate on television." This, he added, will be because advertisers do not like to spend their money with an organization which operates another simultaneous service competing for the same audience. He foresees, however, that aural broadcasting will remain important for specialized programs and that networks will soon be sending one type of program schedule to areas served by television and a different service to those where there are no television stations.

Six rules for visual comfort in viewing television were issued recently by the American Optometric Association. They are:

1. Make sure that your set is properly installed, with particular attention to the antenna, for clearest possible reception.
2. In tuning, adjust audio tone setting before turning the picture up to desired brilliance. Strike a comfortable balance between steadiness of image

and brilliance. Either an unsteady image or too much light will result in visual discomfort.

3. Avoid both intense darkness and bright light in the room in which television is viewed. If the room is totally dark there will be too much contrast between the bright screen and its surroundings. If there are bright lights they will distract you from the screen. Mild, indirect light in the room is preferable.

4. Sun glasses should not be worn for televiewing because they adapt vision to unnatural conditions.

5. Avoid excessively long periods of close concentration on the television screen.

6. In case of discomfort, have your vision examined by a competent vision specialist and follow his advice. Many older persons who wear bifocal glasses may find neither segment suited to television viewing. They may be helped by special lenses prescribed for the proper distance.

Color television's usefulness in teaching medicine and surgery will be demonstrated at the annual meeting of the American Medical Association in Atlantic City in June, under a plan of Smith, Kline and French, Philadelphia pharmaceutical firm, and the University of Pennsylvania. Pickups will be made by CBS in cooperation with Zenith and Webster-Chicago. For four days, surgery and other procedures at the Atlantic City Hospital will be scanned and transmitted in color to 20 receivers in Convention Hall. The system used will be the CBS color-disc.

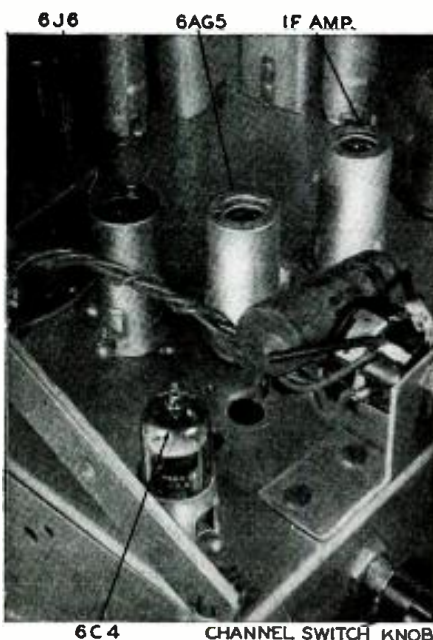

Top-chassis photo shows how tubes are placed.

Students Build TV Transmitter



Full operation is expected late in the year.

By **STEVE LAMOREUX**

IDAHO STATE COLLEGE, by solving the TV parts bottleneck, is also solving that other television stickler—lack of trained men. And in so doing they have demonstrated that TV is still in the amateur's domain.

Plans drawn by a former civilian Navy electronics specialist, William Shiflett, have resulted in what would ordinarily be a million-dollar TV broadcasting setup. It is now being completed at the college for about \$25,000 actual cost, including studio construction.

War-surplus radar parts, rebuilt by students to TV specifications, have been used for the college's 2P23 image orthicon cameras and estimated-100-watt-output transmitter. Completion is scheduled for June, 1949.

TV broadcasts are not the goal, although an experimental wired-TV show

was produced in April, 1948. Trained technicians, scarce anywhere and especially in the West, are the school's product. About 20 per year are being turned out.

Some major components, such as the image orthicon tube, were bought commercially. The all-important tube was received in November, 1947, and the first experimental picture was produced a month later.

Shiflett's three-year course covers radio, electronics, and TV construction. Radio mathematics through calculus covers most of the book work.

In the third year, actual construction is undertaken. The experimental camera and transmitter are used for this purpose.

The gamble taken in attempting high-fidelity construction out of surplus materials has panned out. In April, 1948, the experimental camera produced a picture deemed the equal of that produced by most commercial stations now operating on the West Coast. Immediate construction of the operating station resulted. A thousand TV-hungry Westerners saw the one experimental showing.

The camera and assorted circuits—the sync board, shapers, and control amplifiers—were the first units built. A piece of cavity tuner was used as a window to hold the lens of the tube. Mounting and tripods for the cameras came out of radar sets. All camera-tube sockets and about 120 potentiometers were surplus. About 80% of tubes used were surplus, including high-gain 6AC7's and 6AG5's.

Resistors, capacitors, co-axial lines, and other shielded couplings all came from two carloads of "junk" received in 1945 and 1946 for no more money than freight cost.

Timers, furnishing the six major pulses for control of all equipment, are completely GI, except for the chassis. Coils for broadband amplifiers were wound from what was at one time radar gear.

The shaper cost nothing except hours of hard work. Pulses do not vary over six parts in a million in width, or over six-millionth of a second in timing. Special oscillograph circuits were built to check pulses.

Rebuilt oscillator sections of the BC-688-A receiver, BC-689-A transmitter and other 500-mc gear form a good part of the video and sound transmitters.

Although present students are all veterans, the course will be open in 1949 to others. Shiflett thinks his successful experiment in salvage, science, and human relations shows that the war wasn't a complete loss.

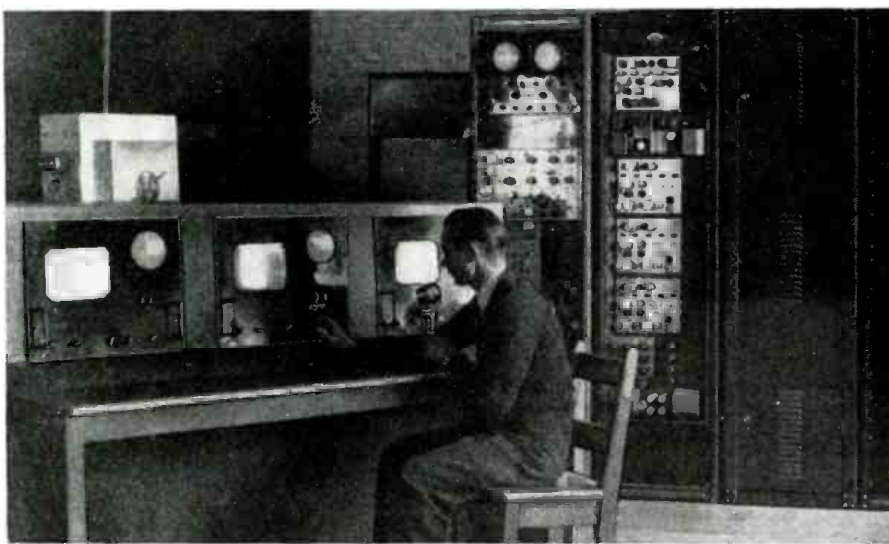

William Shiflett, designer of the station, runs tests on the three-unit monitoring table.

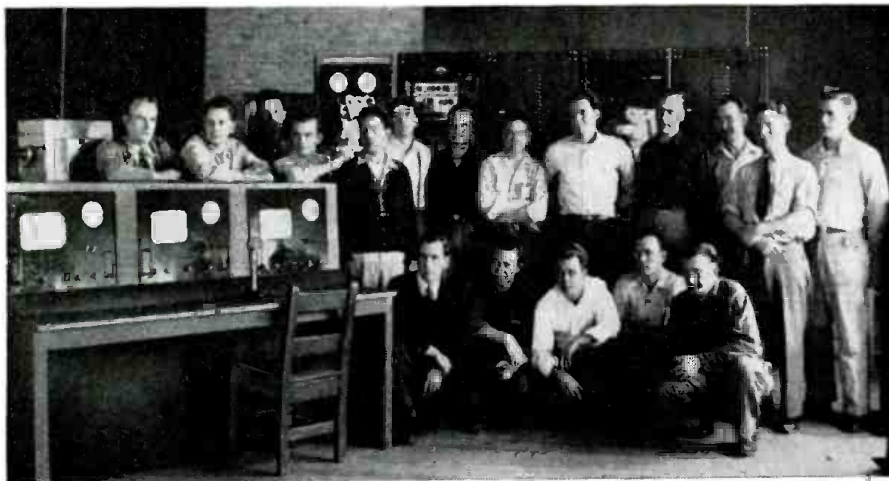

Graduating electronics students at Idaho State College shown with the equipment they built.

Experimental TV Relay

Enthusiasts organize to help viewers

LANCASTER, Pennsylvania, is only 65 miles from Philadelphia. But it is in a valley with a range of hills (the Welsh Mountains) between it and the city. What would be a "fringe area" is thus almost a "null area" because of these hills, and the few experimenters who purchased televisions and erected tall antennas reported the situation to be absolutely hopeless.

But the television experimenters refused to give up and sit quietly waiting for television to come to Lancaster. They went out and got it. Reception from Philadelphia is excellent on the Welsh Mountains. Television enthusiasts began to wonder about bending the rays from Philadelphia's television stations over the mountains and down into Lancaster.

Lancaster has plenty of television enthusiasts. One of the large plants of Radio Corporation of America is located there, and the town has a very high percentage of radio engineers and technicians in its population. A group of them met in April, 1945, to "find ways and means to bring television to the homes of Lancaster." They decided that a relay station on the Welsh Mountains, 15 miles away might be the best answer.

Inquiries showed that Philadelphia television stations would grant permission to relay their programs. The group of enthusiasts organized the Conestoga Television Association in September, 1945, and have worked steadily ever since "to bring television to the homes of Lancaster."

Result of the effort is experimental television station W3XBR, shown on our cover this month. During the winter of 1948-49 it made programs available on a more or less regular basis four nights a week. Quality of picture is usually equal to that in the best receiving locations, stability is excellent and there is little or no trouble from "snow" or man-made noise.

All work has been done on a strictly amateur basis. Members of the Association take turns in operating the station. But the Conestoga group do not use the word "amateur" in describing their activities. They point out that the word



R. E. Barrett of the Conestoga Television Association at the W3XBR controls.

has a very definite meaning in the radio world, and that they are not hams, nor is their station licensed for operation on an amateur frequency. W3XBR is an experimental station, and the members who operate it have commercial licenses.

Transmitting equipment

The video transmitter operating on 600 mc uses four 2C43 10-watt light-house triodes, two in the oscillator and two in the final amplifier. The output is about 7 watts. The tubes are connected in a tuned-line circuit as shown in Figs. 1, 2, and 3. The lines are resonated by the shorting bars which slide along the plate and cathode lines. In addition, small split-stator capacitors, consisting of plates mounted on a shaft so they may be moved toward or away from the plate lines, act as vernier tuners on both the oscillator and the amplifier stages.

Oscillator and amplifier are identical with the exception of the oscillator feedback stubs, which extend from the cathode toward the grid of each oscillator tube through the copper chassis, which acts as a shield. Fig. 2 is a plan of the oscillator and Fig. 3 one of the amplifier. Thus the stubs appear in Fig. 2 only.

A number of modulation systems were tried. The transmitter was first grid-modulated with a low-power, 4-tube modulator which used receiving-type tubes and which connected to point B in Fig. 1. Modulation was about 50%. To approach 100% modulation, a much more ambitious circuit had to be designed. The present modulator has 5 stages feeding a power stage which consists of six 4E27/8001's in parallel. Their output goes to point A in Fig. 1. The circuits of the modulation amplifier appear in Fig. 4, and one of the six identical parallel sections of the modu-

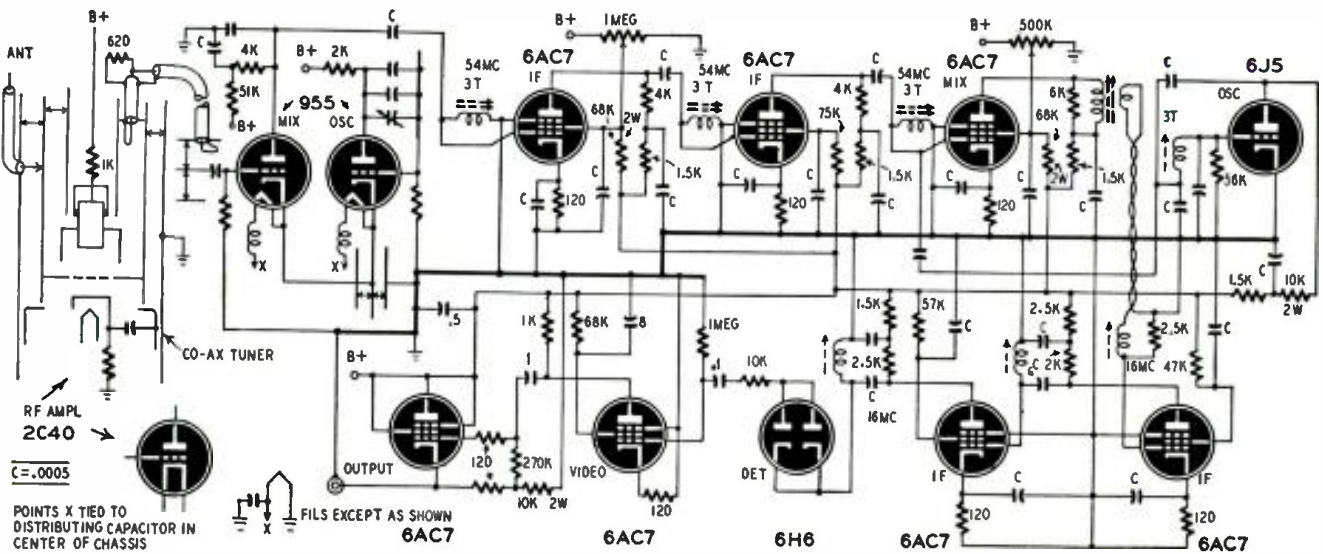

Fig. 6—A surplus ASB-6 radar receiver is used by most viewers to convert the 600-mc signal of W3XBR to one suitable for the TV receiver.

used for reception from WPTZ and one for WCAU. The two corner reflectors immediately below were originally for the sound and vision transmitting antennas. Now the video channel is transmitted from the large parabola below the reflectors, while four stacked vertical dipoles in one of the reflectors transmit the audio channel.

The television situation in Lancaster is a triumph of organized effort. Though any person who desires to receive the signals could do so simply by constructing a converter, without taking on the burdens of membership in the Association, there are no "pirates" and every televiewer is an active worker in the

organization, doing such duties as his qualifications permit. The encouragement of outside organizations, notably the television stations in Philadelphia who permitted their programs to be relayed, and RCA in Lancaster, who loaned the new station much necessary material which might have been too costly to buy, also played an important part.

Lancaster expects a local commercial television station whose programs will probably start in June. How the long-distance relay will be affected is not known, but Association members are looking forward to the changed situation with interest. Will members who

have been accustomed to receiving two stations be content with the single home-town program? And will the operators who have been spending their evenings on Welsh Mountain feel it worth while to continue to do so if television programs are otherwise available? Will W3XBR continue, cease, or change its form of operation? No one knows the answers, but all members of the Conestoga Television Association agree that the work up to the present has already paid off in satisfaction over a job well done, and in television training that could not have been so well obtained in any other, less practical way.

TV SALES TO REACH NEW HIGH IN 1949

TV RECEIVER SALES may bring as much income to radio manufacturers as sales of sound sets in 1949, according to a report released last month by the U. S. Department of Commerce. Written by James B. Forman and Charles P. Redick of the Department and entitled "Trends and Prospects in Radio and Television Receivers," the report relates that TV retail dollar volume amounted to less than 7% of total industry sales in 1947, but jumped to 30% in 1948. If the industry's objective of producing two million TV receivers in 1949 is realized, say the authors, the decline of radio sales and the growth of the television market may well cause a meeting or even crossing of the radio and TV lines on the sales chart shown. Aggregate sales of radio and TV receivers in 1949 is expected to approach the \$1.2 billion reached in 1948, despite the approach to saturation in table-model radio receivers and the slump in radio-phonograph combinations caused by confusion over phonograph records.

The increase in the number of TV set makers is very marked. Before the war only one company was manufacturing

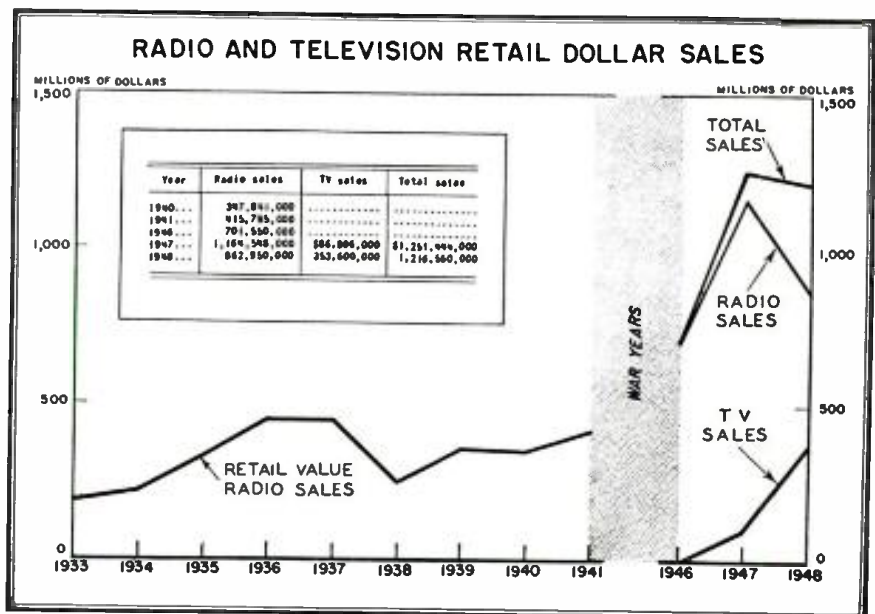

Dept. of Commerce Chart. Source: Electrical Merchandising

televiewers; forty were in the business (or preparing to enter) in mid-1946 and 76 in mid-1948, all but 18 of whom are also active in radio.

Antennas For Television*

Part V—Higher gain and more directive patterns may be obtained by using parasitic arrays and stacking the elements

By
EDWARD M. NOLL
and
MATT MANDL†

THE presence of additional antenna elements increases the gain of simple and folded dipoles. Not only can the antenna system be made more sensitive in the direction of the station but also less sensitive in other directions, reducing the effects of noise and multipath signals. The poor sensitivity to waves arriving at odd angles improves the signal-to-noise and signal-to-interference ratios. It is important to realize, however, that the benefit of a higher-gain antenna can be realized only if antenna is properly matched to transmission line, transmission line matched to receiver (and of proper over-all length), and antenna positioned in the maximum field intensity of a

each other. These so-called *stacked elements* determine the vertical directivity of the antenna system. Vertical and horizontal directivity patterns are shown in Fig. 1.

The vertical directivity of TV receiving-antenna systems should be practically parallel to the earth because television and FM waves are propagated as nearly parallel to earth as possible. The stacked system reduces the sensitivity of the antenna to noises which arrive from beneath the antenna. Thus the stacked antenna is, not only a bit more sensitive in the direction of the station, but assists in the rejection of high-angle radiation from below.

Parasitic elements

A properly matched dipole or folded dipole intercepts a specific section of the propagated wavefront and therefore receives a definite amount of energy. If the antenna has a resistive termination equal to its own radiation resistance, maximum energy will be transferred from it to the receiver. When the antenna is ideally matched, half of the total power intercepted is transferred to the load while the second half is re-radiated from the antenna.

Another antenna element is often introduced to intercept this re-radiated energy. This parasitic element, if spaced properly with respect to the driven element, transfers additional energy to the driven element in proper phase to reinforce the initial power intercepted. Under ideal conditions the presence of a driven element plus either a director or reflector increases signal intensity from 50% to 100%. The additional gain depends on the length of the parasitic element and a correct impedance match between the transmission line and the driven antenna, considering the effect of the parasitic element on the resistance of the driven antenna.

A reflector is 5% longer than the driven element and is placed a certain distance in back of it. Arriving waves strike the driven element which accepts part of the energy. A portion of the energy is re-radiated and moves on to the reflector. At the reflector there is almost complete re-radiation because the reflector is not terminated in a load;

additional energy is transferred back to the driven element in the correct phase to reinforce the initial signal.

The director is shorter by 4% than the driven element and is a certain distance in front of it, that is, between the station and the antenna proper. The arriving wavefront strikes the director first. Again the combination of the arriving wavefront plus the re-radiation from the director produces an increased signal at the transmission line.

Element spacing

The spacing of the director and reflector from the driven element determines the gain and impedance of the antenna. For maximum gain it is customary to space a reflector 0.15 wavelength in back of the antenna and a director 0.1 wavelength in front of it (see Fig. 2). With this close spacing the antenna resistance is lowered substantially. When it is necessary to keep the antenna impedance relatively high, it is possible to space each parasitic element $\frac{1}{4}$ wavelength from the dipole. The gain is brought down somewhat, but reduction of impedance is not great.

Spacing	0.25 λ	0.15 λ	0.1 λ
Reflector	82%	34%	19%
Director	71%	30%	19%
Both	41%	28%	7%

These figures show the resistance of a parasitic array as a percentage of the impedance of the dipole alone, for three different element spacings.

It is very important that the driven element be matched *exactly* to the transmission line if the full benefits of a directive antenna are to be obtained. Obviously, if multi-element arrays are to be used, a folded dipole is preferred over a straight dipole because of the much higher final resistance in the presence of parasitic elements, permitting the antenna to be matched more readily to a 300- or 75-ohm line. The resistance of a plain dipole drops to an exceedingly low value, which increases losses and complicates the matching problem. Furthermore, because of the inherently larger bandpass of a folded dipole, the array retains a substantial bandwidth despite the narrowing effects of the parasitic elements.

When a folded dipole is used, the

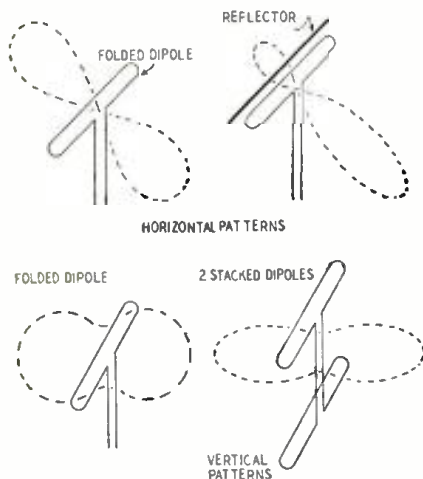

Fig. 1—Vertical and horizontal directivity.

space loop (see Part III, March issue).

Two factors which determine the gain and effectiveness of a directional antenna are horizontal and vertical directivity. Additional antenna elements, reflectors and directors, behind and in front of the dipole cause improved sensitivity in a given direction. There is less sensitivity to signals which arrive from other angles.

Limited improvement can also be obtained with elements positioned above

*From a forthcoming book: *Reference Guide For Television Antennas*.
†Television Instructors—Technical Institute, Temple University.

parasitic elements may still be simple, straight rods. They need not have the folded form. Element length is critical.

In checks made by the authors it was found that with reflector or director correctly cut (reflector 5% longer and director 4% shorter than driven element) some increase in signal strength was apparent when the parasitic element was spaced a quarter-wave, without giving consideration to impedance match. However, for the utmost improvement, the impedance match of antenna to transmission line was every

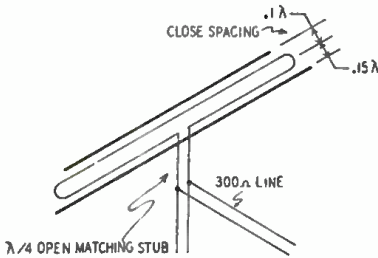

Fig. 2—Standard parasitic element spacing.

bit as important as the presence of the reflector or director.

Complete utilization of the gain added by the parasitic elements can be realized if a quarter-wave matching stub is used, as shown in Fig. 2. In this system an open quarter-wave stub is attached to the antenna and the transmission-line connections are moved up and down the stub until the peak signal point is obtained. If this method is used, a 300-ohm line can be matched to a dipole or folded dipole having one, two, or more parasitic elements. The system, of course, should be matched best for the weakest-signal frequency. A good match will then exist at the third-harmonic frequency.

In summary, the full effectiveness of the parasitic elements is obtained only with correct spacing, careful cutting of elements to correct lengths, and, above all, proper matching of the driven element to the transmission line, considering the change in antenna resistance caused by the parasitic elements.

To assist in finding the correct dimensions for the elements, and the spacings between them, a table has been compiled. It gives information for each channel as well as for compromise systems for high and low bands. Dimensions given for folded dipoles indicate the total length between one terminal and the other. Free-space dimensions for various parts of a wavelength are also given for use in obtaining proper stub lengths and spacings between elements. All of these dimensions are based on an air dielectric. When other than air is used (as in transmission through sections of line) the dimension given should be corrected by multiplying it by the velocity constant of whatever dielectric is used (see manufacturer's specifications).

Stacked arrays

If driven antenna elements are stacked vertically, antenna gain is somewhat increased because sensitivity

ANTENNA DESIGN TABLE

Chan-nel	Center fre-quency	Di-pole length	Re-lector length	Di-rector length	Folded dipole	Coni-cal element	Free-Space Dimensions of Waves						Channel limits	
							λ	λ/2	λ/4	0.1λ	0.15λ	3λ		10λ
2	57	97.2	101	93.3	207	73.7	202	101	50.5	20.2	30.3	51.9	173	54-60
3	63	88	92.3	84.4	181	66.7	182.8	91.4	45.7	18.3	27.4	46.8	156	60-66
4	69	80	84.3	77	166	60.9	166.8	83.4	41.7	16.7	25	42.9	143	66-72
5	79	70	73.6	67.3	145	53.2	145.6	72.8	36.4	14.6	21.8	37.2	124	76-82
6	85	65.2	68.2	62.5	134	49.4	135.6	67.8	33.9	13.6	20.3	34.8	116	82-88
7	177	31.2	32.8	30	64.7	23.7	64.8	32.4	16.2	6.48	9.72	16.7	55.6	174-180
8	183	30.2	31.8	29	62.6	22.9	62.8	31.4	15.7	6.28	9.42	16.1	53.7	180-186
9	189	29.2	30.8	28.1	60.6	22.2	60.8	30.4	15.2	6.08	9.12	15.6	52	186-192
10	195	28.4	29.8	27.2	58.7	21.5	58.8	29.4	14.7	5.88	8.82	15.1	50.4	192-198
11	201	27.6	29	26.4	57	20.9	57.2	28.6	14.3	5.72	8.58	14.7	49	198-204
12	207	26.8	28.2	25.7	55.3	20.3	55.6	27.8	13.9	5.56	8.34	14.3	47.5	204-210
13	213	26	27.3	24.9	53.8	19.7	54	27	13.5	5.4	8.1	13.9	46.2	210-216
Low Band	71	78	81.9	74.9	161	59.1	166.3	83.2	41.6	16.1	24.2	41.7	138	
High Band	185	28.4	29.8	27.2	58.7	21.5	58.8	29.4	14.7	5.88	8.82	15.1	50.4	

All frequencies in megacycles; all dimensions in inches except 3λ and 10λ, which are in feet.

to waves traveling parallel to the earth is increased. Stacking two dipoles one-half wavelength apart increases voltage delivered to the transmission line by 40%, provided the system is properly matched. If the terminals of two driven elements are paralleled, net antenna resistance is halved.

Stacked antennas connected in phase have maximum sensitivity broadside, just as a single dipole. However, phase relation is affected by the feed system.

The two basic methods of feed are shown in Fig. 3. With the method of a, the signals picked up by the two dipoles are in phase, but the upper-dipole signal is reversed after it passes through the half-wave section of line. To correct this, the feeders must be transposed as shown. At b, signals from both dipoles travel the same distance before they meet and no correction is necessary.

A most important characteristic of the stacked antenna is its ability to reject noises arriving at other angles than broadside. For example, a signal arriving from beneath the antenna (street noises, etc.) would induce out-of-phase signals into the two elements (longer path to top antenna element) and signals would cancel at the point where the transmission line is attached. Thus the stacked antenna is particularly helpful in noisy locations.

The stacked array, in addition to contributing more gain, remains bidirectional, an advantage when reception from opposite directions is desired. Reflectors and directors can be used for each element of the stacked system, however, to make it unidirectional, with still higher gain in the chosen direction. Again proper impedance matching is essential, a matching stub doing wonders for any one stubborn station. Actually, because of the very limited additional gain acquired by stacking (only 40% for two stacked elements ideally matched), the rejection of noise should be the only reason for doing it. It was noticed that with a number of stacked systems, due to mismatch and nearness of the antenna to ground, signal strength increased when one driven element was removed. The effects of ground are evident when we consider that the nearer the stacked antenna is to ground (or to the grounded struc-

ture upon which it is mounted), the greater the ratio between signal contributed by the top element and that of the lower one.

A very simple system for approximately matching two stacked folded dipoles is the transposed-feeder method (Fig. 3-a). In a typical case, 300-ohm line was run to the lower element, connected, given a half-twist, and continued on to the top element. Spacing between the stacked elements should be 85 to 90% of a half-wave because of the velocity constant of the line. This system delivered a bit higher signal level than a center-feed system. Various element spacings—half-wave, quarter-wave, and eighth-wave—were tried with no apparent improvement.

Best results with a center-feed system (Fig. 3-b) were obtained when the

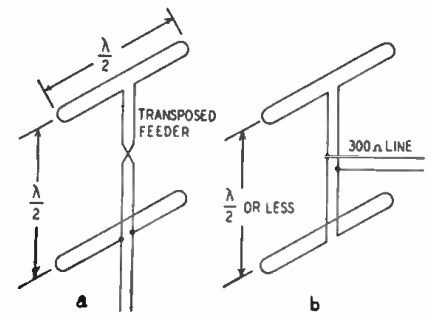

Fig. 3—Two way of joining stacked elements.

section of line between driven elements had a surge impedance which approximately matched the antenna to the center point of feed. For example, if two stacked folded dipoles are used, each has a 300-ohm resistance which should be transformed to 600 ohms at the point where the 300-ohm transmission line is attached. If the section between each antenna and the center feed point has a surge impedance of $\sqrt{300 \times 600}$ or about 420 ohms, it will act as a quarter-wave matching section. Element spacing did not appear critical from the signal-strength standpoint, although half-wave spacing gives the best noise cancellation.

In the next article of this series special antenna types will be discussed and comparisons made with conventional dipoles. An unusual high-directivity, high-gain antenna will be shown.

Electret Behavior

It is possible to evaluate electret behavior in spite of the dearth of theoretical knowledge prevailing

By EDWARD D. PADGETT

TO develop new industrial uses for the electret, the electronic technician should become acquainted with the properties of and the compounds that form electrets. As first shown by Mototaro Eguchi of the Higher Naval College of Tokyo, an electret is formed when certain dielectric materials solidify in a strong, externally applied electric field. The electric field causes the molecules of the dielectric to become oriented or polarized in the direction of the field. As the mixture solidifies, the polarized molecules are frozen into a fixed position. Events that occur inside the polarized dielectric cause the free charges that characterize an electret. At room temperature one electret surface has a positive electric charge and the other surface is charged negatively. Covering the electret with a metal-foil keeper preserves the charges indefinitely.

This electric charge property is related to the polar groups ($-\text{OH}$, $-\text{COOH}$) that occur in certain high-melting-point compounds. (Polar groups are groups of atoms with positive and negative electrical poles.) Mixtures of Carnauba wax and hydrogenated rosin (Hercules Staybelite resin) have polar groups and form electrets. Paraffin waxes have no polar groups and, in themselves, do not form electrets. However, paraffin waxes in mixture with Carnauba will form electrets because the Carnauba has polar groups.

Despite a lack of basic knowledge about the behavior of oriented polar compounds, practical information about electrets can be obtained from a number of experiments that can be made on

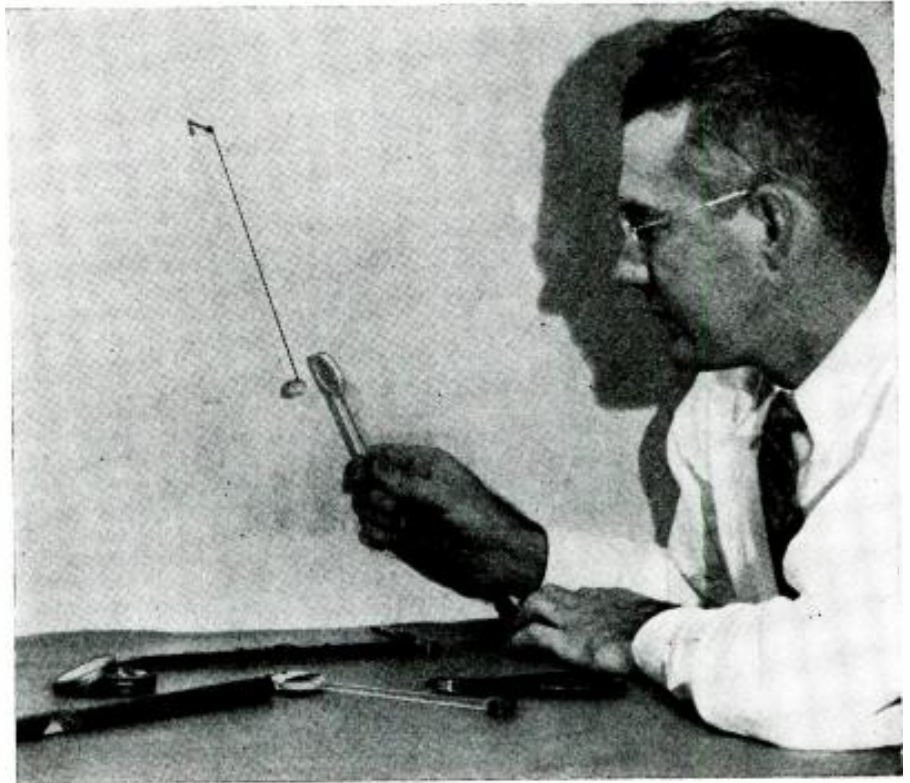

Edward Padgett, the author, shown experimenting with one of his electrets.

the dielectric mixtures. Among the tests and analyses are potential-distribution curves inside the electret, x-ray diffraction patterns, cooling curves, and ammeter tests. The experimental results suggest the interesting hypothesis that the free charges on the surfaces of wax electrets are the result of *ionization* of some of the constituents in the wax. However, until new information about oriented polar compounds is available to support the experimental evidence, this hypothesis must not be regarded as a theory of electret behavior.

Andrew Gemant, one of the early electret workers, was the first (1935) to propose an ionization explanation. He inserted probes in the cooling Carnauba wax as an electret was being made. From the data he prepared curves of potential distribution inside the wax *versus* electrode distance (Fig. 1). He found that potential distribution was nonsymmetrical with respect to the two electrodes. The graph shows that the nonsymmetry becomes more pronounced as the wax temperature decreases. Gemant said this was due to different *ion mobilities* inside the wax; cation (positive ion) mobility was greater than anion (negative ion) mobility when the

wax was in a molten or plastic condition (for wax temperatures down to 70 degrees C).

Professor Gemant hinted that this explanation might hold when the polarized dielectric was cooled to room temperature; for the solid wax he found a

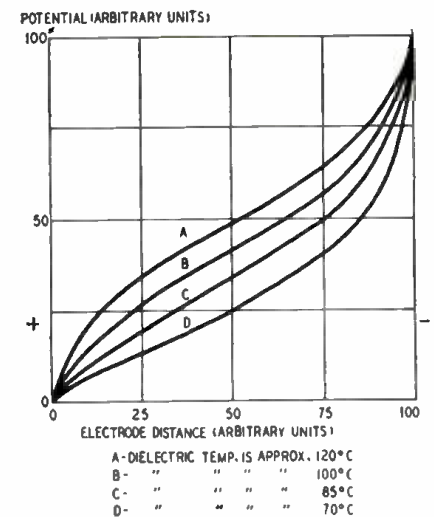

Fig. 1—Curves show potential distribution. RADIO-ELECTRONICS for

positive space charge at the cathode. Independent tests indicate that his explanation will hold when the wax is at room temperature. An X-ray analysis proves that when it is allowed to solidify in an externally applied electric

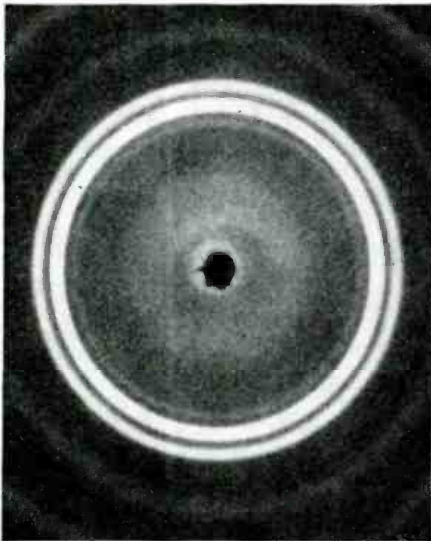

Fig. 2—Diffraction pattern of Carnauba wax.

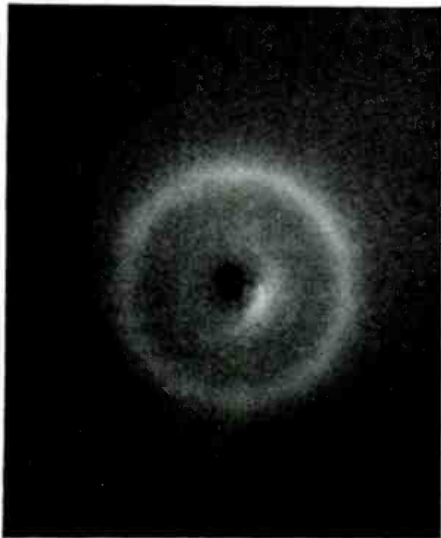

Fig. 3—Halo pattern from hydrogenated rosin.

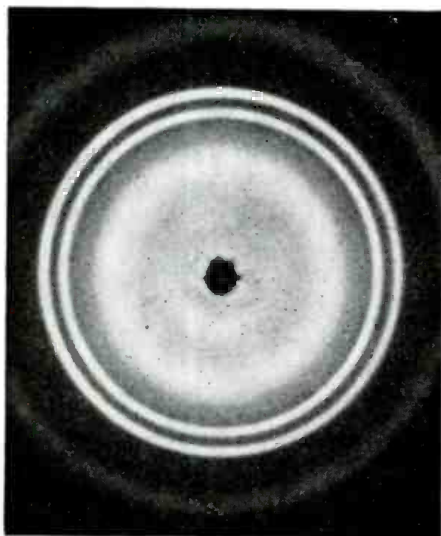

Fig. 4—Composite pattern of Figs. 2 and 3.

field, Carnauba wax becomes polarized. In other words, the wax acquires an internal electric field of its own during the polarization process. When the wax is hard enough (cooled to room temperature), this internal field is retained indefinitely and can manifest itself long after the electret is removed from the making electrodes. If large enough, the internal field can ionize (or excite) certain constituents in the wax. The ions can migrate toward the polarized surfaces and form the free surface charges on the electret because of the internal field and a certain amount of ion mobility tends to manifest itself inside the wax.

The electret is the electrical analog of the so-called permanent magnet. A keeper on a magnet maintains the direction of the internal magnetic field inside the iron, and the magnet keeps its pole strength indefinitely. The keeper on an electret maintains the direction of the internal electric field inside the polarized dielectric, and the electret keeps its free surface charges indefinitely. The precise mechanism of what happens inside the electret involves controversial and theoretical questions that will be answered when more information is obtained on the various phenomena involved.

If the keeper is removed from the electret, there is a reversal of the internal electric field. Experimental evidence indicates that this reversal is not instantaneous, but occurs instead in a series of jumps. This means that the decrease in the magnitude of free surface charge occurs in a series of jumps. The type of decrease indicates that there is either a rotation of the molecules, or changes in the distance between molecules or ions inside the electret. This is not a piezoelectric effect in the strict sense of the word—waxes are too soft, relatively, to show appreciable piezoelectric effects. Rather, it is an internal effect caused by oriented polar compounds. Additional knowledge about polar groups, concepts of quantum theory, and the number of degrees of freedom of atoms and molecules must be used to explain these jump effects more fully.

X-ray analysis

An externally applied electric field of between 5,000 and 10,000 volts per centimeter must be applied to the molten dielectric to produce satisfactory electrets. X-ray diffraction patterns prove the dielectric is polarized by this strong field. The patterns shown in this article were made with the k-alpha doublet from a copper-target X-ray tube operating for 20 minutes at 40 kv peak and 20 ma. The spot in the center of the pictures is due to the blocking out of the primary X-ray beam. These pin-hole patterns were taken by the writer in the X-ray laboratory of the University of Illinois.

The distance *d* between layers of a crystal is of the order of Angstrom units (1 A.U. = 10⁻⁸ cm). Since the wavelength *L* of X-rays is of the same

order, a crystal acts on X-rays as a diffraction grating acts on light. Diffraction of X-rays is governed by the well-known Bragg equation, $nL = (2d) (\sin \theta)$. If a substance has a definite, repeating crystalline structure, X-rays will be diffracted in certain directions only, resulting in an X-ray pattern on a photographic film that is characteristic of the structure or substance. Organic compounds like Carnauba wax yield diffraction patterns that are clearly defined, smooth rings (Fig. 2). If the crystallites of a substance are very small and distributed in a random, non-repeating manner, the X-rays will be scattered in all directions, resulting in diffraction patterns that are broad, diffuse halos. Compounds like glass and hydrogenated rosin yield these broad halos. Fig. 3 shows a halo from hydrogenated rosin. Note how it conforms to the description.

Any substance can be identified or "fingerprinted" by X-rays because it has its own characteristic diffraction pattern. If two substances are mixed together and there is a chemical reaction, an X-ray diffraction pattern will show new rings or lines because of the new compound formed by the reaction. Unpolarized mixtures of Carnauba wax and hydrogenated rosin show no new

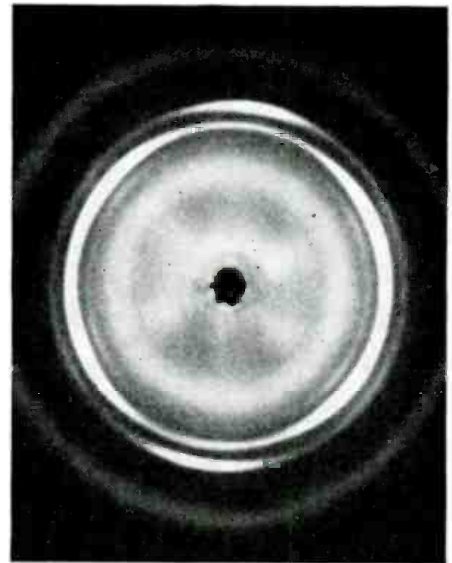

Fig. 5—Diffraction pattern of an electret.

rings, hence, no chemical change is caused by mixing these two substances together. X-rays prove that mixtures of Carnauba wax and hydrogenated rosin

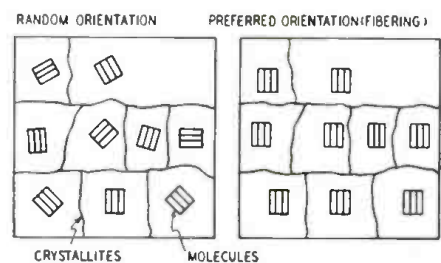

Fig. 6—Schematic illustration of fibering.

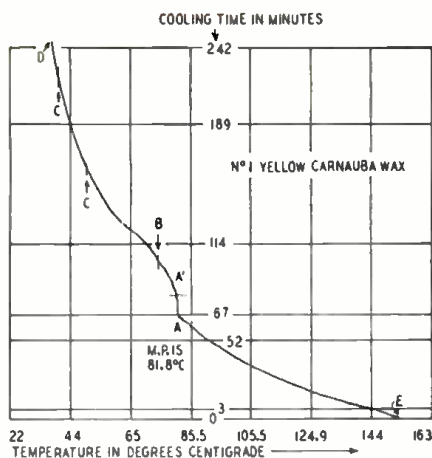

Fig. 7—Cooling characteristic of Carnauba.

are physical mixtures, not a new chemical compound. The diffraction pattern of the mixture merely shows a superpositioning of the individual patterns of the two substances. If Fig. 3 were added to Fig. 2, the resulting pattern would be identical to the diffraction pattern of the mixture (Fig. 4). In this photograph note the uniform photographic density of the closely spaced rings and the broad inner halo.

Fig. 5 is a diffraction pattern of an electret. Note the nonuniform photographic density of the rings and the broad inner halo. Such diffraction rings are characteristic of materials that show "preferred orientation" or fibering. In this instance the fibering is due to the polarization or orientation of the dielectric caused by the previously applied electric field from the power supply. Fibering means that an electret has a higher degree of orientation or organization than the unpolarized dielectric. Fig. 6 is a schematic illustration of fibering.

Other electret tests

In addition to the knowledge from the X-ray analysis, further information about electrets can be obtained from cooling curves of the dielectric mixtures. A copper-constantin thermocouple is inserted in the molten dielectric in a test tube. The thermocouple is connected to a recording potentiometer. The pen of this instrument draws cooling curves which show the time *versus* temperature relationships as the dielectric cools. (Discussions of the equipment used in testing electrets and photographs of the Leeds and Northrup recording potentiometer appeared in the April issue.)

Carnauba wax is crystalline in structure and is a unique solid solution of a homologous series of esters. Esters can have one or more *crystal transition* states. This means that at a certain temperature all the wax molecules are lined up in a certain direction and at a certain angle with respect to the vertical. In the region of the melting point the molecules line up vertically, like the pile in a rug. A change in crystal transition means that at a certain temperature all the molecules suddenly tip over

at an angle with respect to the vertical. In the tipping over process heat energy is lost by the molecules. The energy loss is detected by the thermocouple and causes slight dips or bulges in the cooling curves. Thus point B in Figs. 7 and 8 is the center of a region of *crystal transition*. To see the bulges clearly, hold the paper parallel to the eye and sight along the curve. Irregular points like C on the graphs are due to the adjustment of the recording potentiometer.

When No. 1 yellow Carnauba wax cools in an oven, the curve of Fig. 7 is obtained. As the wax cools, it goes from a molten state (above 81.8 degrees C) through a vertical inflection point at 81.8 degrees (point A on the graph) into plastic and solid states (below 81.8 degrees C). In other words, from E to A on the cooling curve the wax is molten. At point A the wax cools through its melting point and begins to



This test tube was cracked when Carnauba wax was cooled in intense electric field.

solidify. At A' most of the wax is in a soft, plastic state. From A' to D the wax cools to solidification.

When Carnauba wax cools in an electric field, the curve is similar to that of Fig. 7 except for one important difference. This difference is that there is a slight lowering of the melting point of the wax. The electric field causes either preferred orientation of the wax or ionization of some of the constituents in the wax or both. In either case the wax takes energy from the applied electric field. Energy is taken gradually and in the melting point and crystal transition regions. This latter effect shows on a cooling curve only when the applied voltage is slightly greater than the breakdown strength of the dielectric. In this event arc-overs occur between the parallel-plate electrodes in the test tube. The voltage breakdowns in the wax occur with almost explosive noise and violence when the temperature of the cooling wax, as indicated by the

lines drawn by the potentiometer pen, passes into the melting-point and crystal-transition regions. A test tube containing a thermocouple, brass electrodes, and Carnauba wax cracked by the application of the intense electric field during these tricky tests is shown in a photograph.

When Hercules hydrogenated rosin (Staybelite resin) is added to the Carnauba wax, the melting point of the mixture is lower. Also, the center of the crystal transition region (point B in the graphs) is at a lower temperature. This is shown in the cooling curve of a mixture of equal parts of Carnauba wax and hydrogenated rosin (Fig. 8).

Ammeter tests on wax electrets give useful information. Interestingly enough, pure hydrocarbons are essentially nonconductors of electricity in the molten state. A microammeter in the high-voltage circuit, when making an electret, shows currents of surprisingly large magnitude (approximately 400 microamperes or greater when the wax is at 90 degrees C). The specific resistance of Carnauba wax (considered as a mixture of hydrocarbon derivatives) is approximately 60×10^{13} ohm-centimeters at 30 degrees C. According to Ohm's law, currents measurable in micromicroamperes should flow through the dielectric. In practice, microamperes are observed. The large currents are due either to strong polar properties or to ionization of some of the wax components. These components are mixtures of esters of higher alcohols and acids, and impurities, such as inorganic salts, that are inherent in the wax. Undoubtedly, the ion currents contribute to the magnitude of the free surface charges on wax electrets.

In summation, then, a series of independent tests indicates that the electric charges on wax electrets are associated with the orientation of polar groups that occur in certain compounds. Unpolarized mixtures of Carnauba wax and hydrogenated rosin are physical mixtures. X-ray diffraction patterns prove that wax electrets consist of certain polarized dielectric materials.

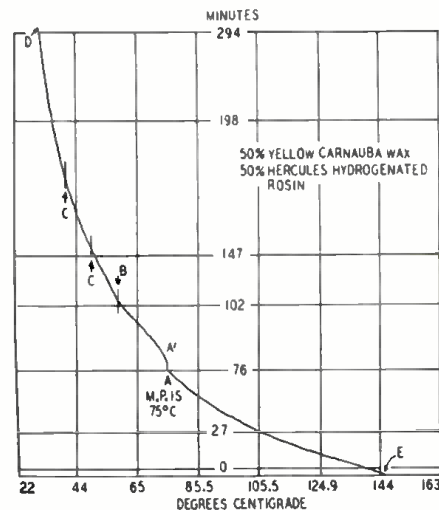
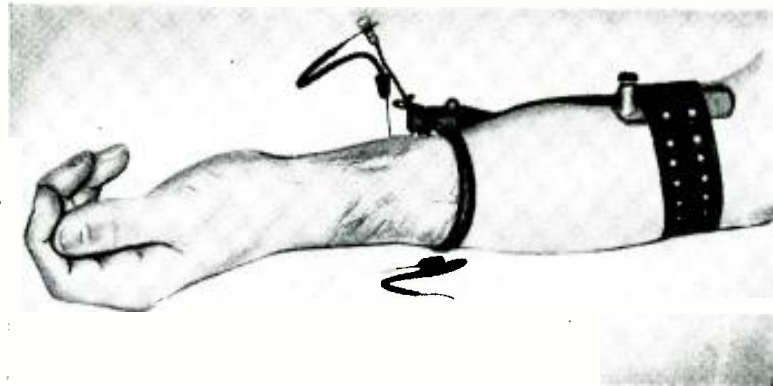

Fig. 8—How a Carnauba-rosin mixture cools.

ELECTRONICS IN MEDICINE

Part VII—Devices to measure the activity of the muscle fibers

By EUGENE J. THOMPSON



The insulated metallic needle is thrust into the arm. The bare tip picks up impulses.

ELECTROMYOGRAPHY is an electronic method of recording the electrical activity of muscles. Developed during the last war to study nerve injuries, it is now used to study diseases such as infantile paralysis.

The action potentials are picked up with a fine, metallic needle, thrust through the skin and into the muscle as in Fig. 1. The shaft of the needle is insulated, only the extreme tip remaining bare. This makes it possible to contact individual muscle fibers or collections of fibers known as a motor unit, which are controlled by only one nerve fiber.

The action potentials are measured with respect to a reference electrode placed on the skin nearby. A third, grounded electrode is attached to a distant, neutral part of the body to reduce stray electrical interference. The needle and reference electrode are connected to the input grids of a push-pull amplifier.

The action potentials are then amplified sufficiently to be seen or photographed with an oscilloscope and camera attachment and to be heard on a loudspeaker. The appearance and sound of the waveforms can be analyzed by an experienced electromyographer.

Individual muscle fibers emit small monophasic and diphasic transient discharges lasting 1 to 1.5 milliseconds at .01 to 0.3 millivolt. They appear in trains when the nerve supply to a muscle is destroyed, and have a crackling sound when heard on the speaker.

Motor-unit potentials last 5 to 7 milliseconds, range between 1 and 10 millivolts, and are di- or triphasic. A combination of motor units discharging simultaneously may produce amplitudes of 30 to 40 mv. Motor-unit potentials appear only when the muscle contracts, with a few exceptions. They sound like machine-gun fire.

The electromyograph recorder is composed of three major components:

1. A high-gain, low-noise-level, wide-range, calibrated, balanced, push-pull preamplifier, with built-in calibrator (Fig. 2);

2. A cathode-ray oscilloscope with photographic attachment, incorporating a nerve and muscle stimulator with variable duration and intensity (Fig. 3);

3. A combination mobile loudspeaker cabinet and table including the speaker, power amplifier, battery, and battery charger.

The preamplifier (Fig. 2) comprises three stages of push-pull, resistance-capacitance coupled voltage amplification. The advantages of the push-pull circuit in medical electronic equipment have been discussed in earlier articles. It is possible to obtain linear amplification of all input voltages between 10 microvolts and 100 millivolts by means of the balanced, tandem, 10-step attenuators R7, R8, R13, R14. Each attenuator

has a loss of 3 db per step, making a total of 6 db per step for both stages. The frequency response is flat ± 1.5 db from 10 to 4,000 cycles. The time constant is 0.1 second.

Extraneous electrical interference is

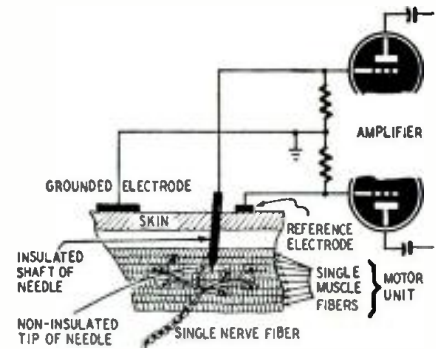

Fig. 1—Bare needle tip touches muscle fiber.

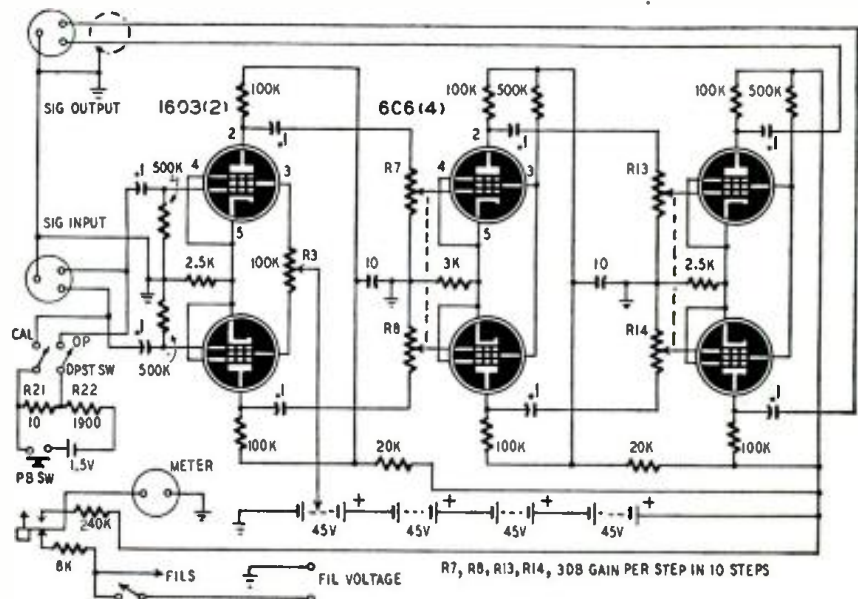

Fig. 2—This high-gain, low-noise, wide-range amplifier magnifies muscle action potentials.

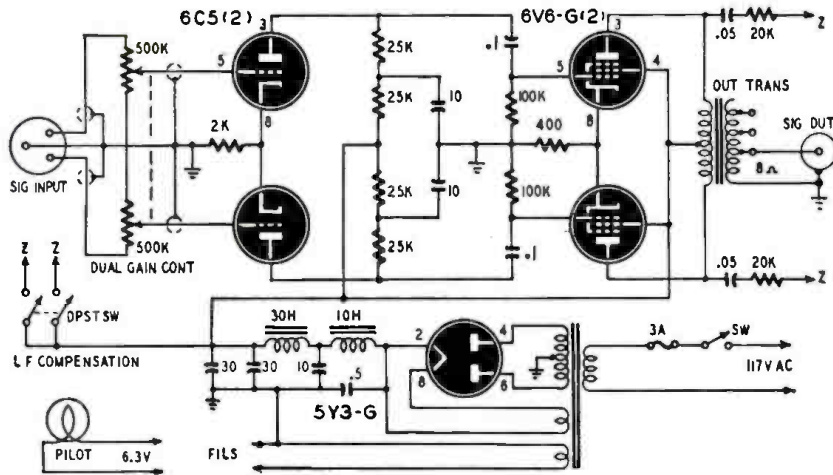
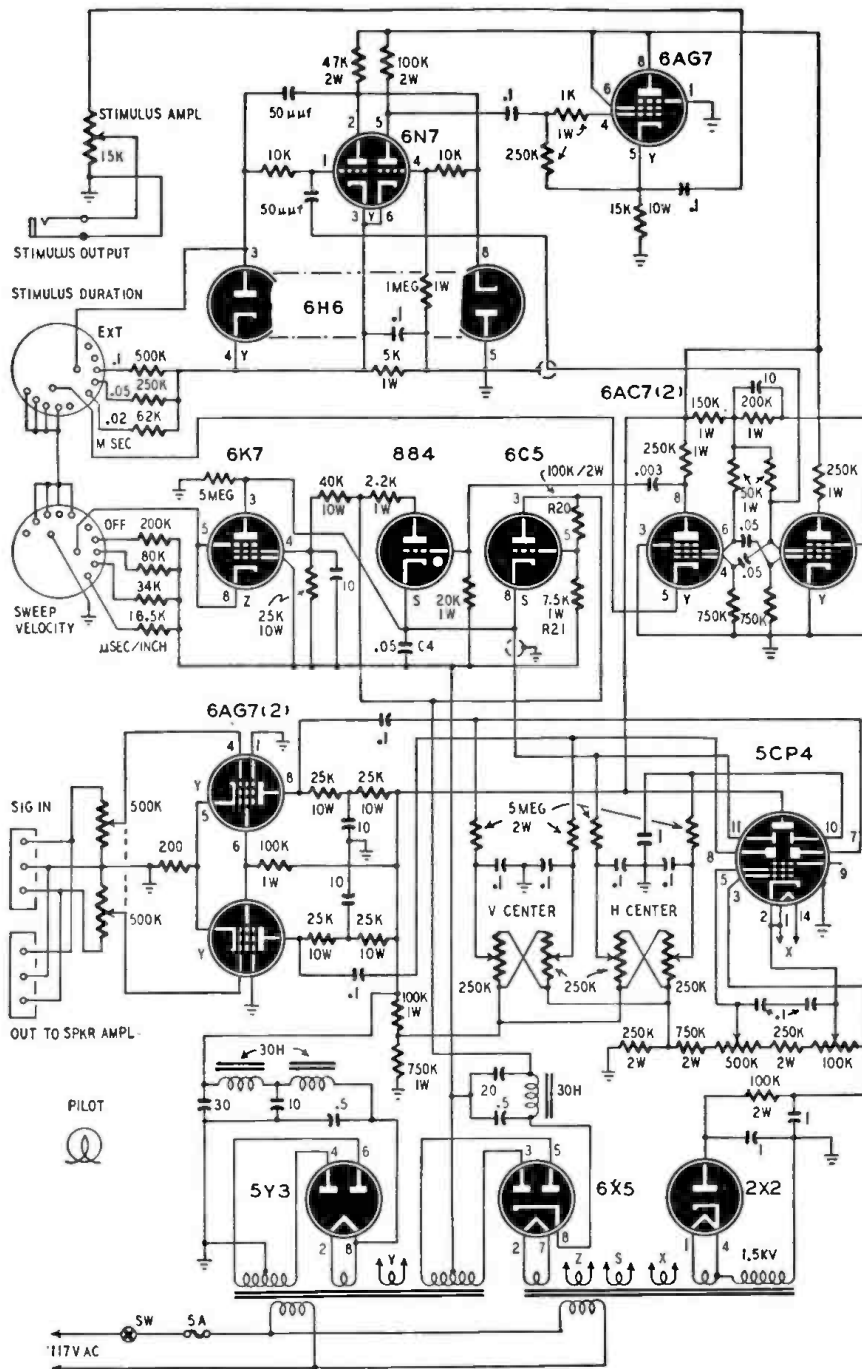

Fig. 4—The power amplifier. Listening to the impulses, the physician's diagnosis is aided.



reduced without shielding by the screen-grid-balancing potentiometer R3. Inasmuch as such interference appears principally as a grid-ground signal, R3 can be varied to make the undesirable signals of equal amplitude. Since they are already 180 degrees out of phase, they cancel. Mechanical tube noises are reduced by using 1603's (non-microphonic 6C6's) in the first stage. These are mounted in rubber-cushioned ceramic sockets. Precision wire-wound resistors in the first stage plus careful shielding reduce inherent noise still further.

The calibrator circuit consists of a 1.5-volt battery, R21, R22, and a push-button. When the OP-CAL switch is thrown to CAL, depressing the CAL button introduces an 0.8 mv square-wave pulse. The oscilloscope vertical gain control can then be adjusted to secure the desired deflection.

The output of the preamplifier is fed into the vertical deflection amplifier of the cathode-ray oscilloscope (Fig. 3). This consists of two 6AG7 beam-power tubes which, because of their high trans-conductance and high plate current, deliver a high voltage across a low plate-load impedance. This produces linear deflection, because the beam goes off the face of the 'scope before the tubes are driven past the linear portion of the characteristic curve.

The sweep generator employs an 884 thyatron, 6K7 constant-current pentode, and a 6C5 limiter. Normally, the 884 thyatron is biased to cutoff, and is prevented by the 6C5 limiter, connected in parallel with it, from flashing or conducting. However, a simple positive pulse from the multivibrator raises the grid bias of the thyatron, causing it to conduct, charging C4. This is then discharged at a linear rate through the 6K7 constant-current pentode. When the potential across C4 drops to a low value, the grid of the 6C5 limiter is driven positive with respect to the cathode (since the cathode is made more negative than the bias impressed on it by R20 and R21). As a consequence, the 6C5 conducts heavily, preventing further conduction of the thyatron until the next positive trigger pulse arrives from the multivibrator.

The multivibrator consists of two 6A7 pentodes in which the screen grids are used as plates for the switching action. The circuit provides positive pulses for triggering the sweep generator and negative pulses to trigger the muscle and nerve-stimulator circuit. The frequency is set at 7.5 cycles.

The square-wave pulse from the appropriate plate of the multivibrator is passed through a differentiating network to produce the sharp, positive trigger pulse for the sweep generator. The negative trigger pulse is obtained from the grid of the nonconducting tube of

Fig. 3—The muscle impulses show up on this oscilloscope for visual evaluation. The same unit furnishes potentials for stimulating the nerves and muscles with currents of variable intensity in pulses of adjustable duration.

the multivibrator as its voltage suddenly swings negative.

The output of the stimulator circuit is a negative square-wave pulse with a recurrence frequency of 7.5 cycles. The duration may be set at 1, 0.5, and 0.2 millisecond, and the amplitude varied from zero to -90 volts.

The stimulator is composed of a 6N7 one-shot multivibrator triggered by the negative pulse described above. The output, a negative square wave, is passed through the 6AG7 cathode follower. This arrangement minimizes distortion of the square-wave stimulus.

The 6AG7, which is normally conducting heavily, is made to conduct less by the negative square-wave input from the 6N7. The fall in current in R41 results in a negative square-wave output. The duration of the stimulus is kept constant by the 6H6 duration limiter which stabilizes the grid-voltage excursions of the two triode sections of the 6N7.

The power amplifier (Fig. 4) is a two-stage, resistance-capacitance-coupled circuit, with frequency compensation in the plate of the first stage. The output is flat from 10 to 10,000 cycles, but the lows may be accentuated and the highs attenuated by switching in the low-frequency booster. The output is 6 watts undistorted. Careful attention to power-supply design is responsible for the extremely low hum level of the instrument.

With the exception of Fig. 1, all illustrations for this article are presented by courtesy of Dr. H. H. Jasper.

NEW RADIATION DETECTOR

A new electronic scintillation counter was developed recently by Dr. George B. Collins, head of the Physics Department of the University of Rochester, N. Y.

Scintillation was the first method used by atomic physicists to count radioactive particles. Using a microscope, the scientists counted the tiny flashes of light that are made by the particles as they hit a fluorescent screen. When the Geiger counter and other detectors were invented, the scintillation method, which was extremely tedious, was dropped.

Dr. Collins, however, has made the scintillation counter completely automatic. A small block of anthracene (a coal-tar product) is placed on the end of a quartz or Lucite rod. The flashes of light produced by the anthracene when it is bombarded by radioactive particles are "piped" through the rod to a multiplier phototube which produces electrical impulses and passes them along through an appropriate amplifier to a counter.

According to Dr. Collins, scintillation counters can count faster than Geiger counters. They are more sensitive to hard gamma rays and the choice of phosphor (anthracene or other) can determine the device's relative sensitivity to alpha and beta particles. The light-conducting rod allows the phosphor to reach into tight places.

MAY, 1949

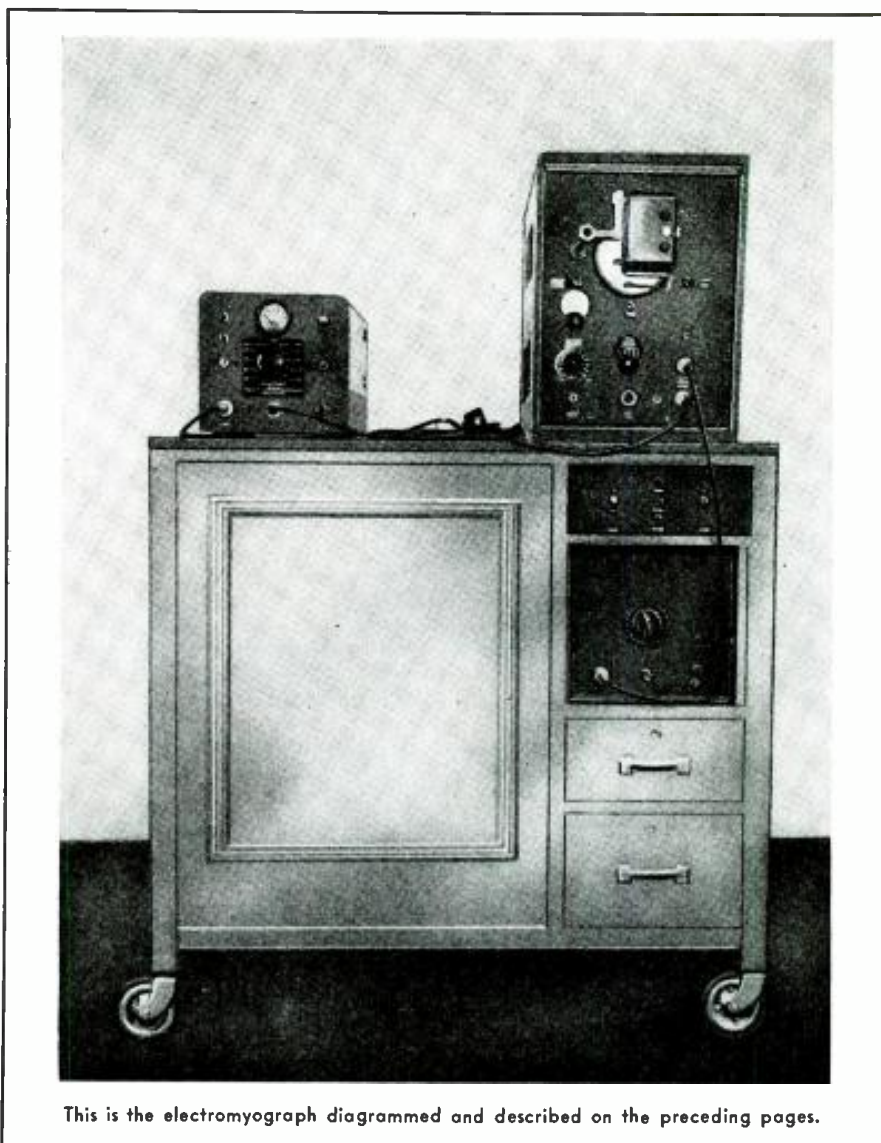

This is the electromyograph diagrammed and described on the preceding pages.

FIRST AMERICAN PORT TO GET RADAR

THOUGH England is the world's first nation to have installed a port radar system ("Radar Eyes Bring Safety to Fog-Bound Liverpool," RADIO-ELECTRONICS, December, 1948), the U.S. will not be far behind in furnishing radar protection to marine traffic. This country's initial installation was authorized recently by the Board of Harbor Commissioners of Long Beach, Calif. Equipment for the installation will be furnished by the Sperry Gyroscope Co.

A radar scanner atop a 120-foot steel derrick at the end of a pier in Long Beach's Outer Harbor will transmit to the operator in the pilot house the position of every ship in the San Pedro Bay area within a distance of 10 miles. The radar operator will inform ships of their exact positions by two-way radio, even in the midst of the heavy fog banks which roll in from the sea. Harbor pilots will carry portable equipment for communication with the radar operator, and pilot boats will have permanent installations. With radar and the two-way radios, it will be possible

to direct any vessel safely through the entrance in the breakwater system to any desired berth.

The procedure employed during bad weather will be similar to the Ground-Controlled Approach method used with aircraft. With the aid of a mobile radar station, aircraft are "talked down" in the GCA system—ground observers watching the radar 'scope know the plane's position and tell the pilot by radio every few seconds exactly what to do to maintain proper approach.

The Long Beach ship radar will operate with approximately the same procedure, except that the radar station will be fixed. Like GCA, the port radar will be accurate to within 50 feet. The shore operator will be able to act only in an advisory capacity, as all responsibility for control and direction of the ship rests with the pilot.

Because of its novelty, the system will be operated at first on an experimental basis, but it is expected to prove so vital that all major American ports will follow Long Beach's pioneer example.

Build A TRANSISTOR

Experiments show that the average experimenter can construct a crystal amplifier from parts of 1N34's

By RUFUS P. TURNER, K6AI



End plug at right holds the two catwhiskers.

SINCE the sensational announcement of the crystal triode, or transistor, several months ago, radio experimenters have been waiting impatiently for manufactured versions of this device. We have communicated with several manufacturers known or expected to be planning transistor production, but have obtained no commitments as to a date on which crystal triodes might be expected to appear on the market. In the meantime, a few brave souls have made simple experimental transistors for the prime purpose of doing a little advance playing with the gadget; most builders, however, have complained of electrical instability and lack of mechanical ruggedness.

The author has constructed several transistors employing various mechanical arrangements. Although the electrical behavior of some of the models was interesting and quite satisfactory, all suffered more or less from mechanical delicacy. In each case, the germanium wafer and the two S-shaped, pointed, tungsten whiskers required were obtained by disassembling two 1N34 crystal diodes. One whisker is obtained from each diode, and one germanium wafer is left over for experimentation. The 1N34 undoubtedly has been the source of parts for all home-made transistors built up to this time.

Without going into the theory of transistor operation in this article, we show the basic arrangement of a crystal triode as an amplifier in Fig. 1. An oscillator circuit also can be made by introducing feedback between the output and input portions of the triode circuit. From this drawing, it may be seen that the transistor is simply a two-whiskered crystal unit. The emitter whisker is biased with a low positive voltage and is comparable to the control grid of a

triode tube. The collector whisker receives a much larger negative voltage from a B-battery and is comparable to the plate of a tube. The germanium wafer, commonly referred to as the crystal, is comparable to the cathode of a tube. In order to obtain transistor action (that is, to have the emitter voltage control the collector current in much the same fashion as the grid voltage of a tube controls the plate current), the two whiskers must touch the germanium surface firmly at points ex-

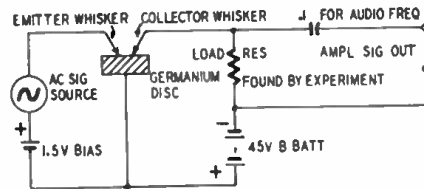

Fig. 1—This is a basic transistor amplifier.

tremely close to each other (.002-inch separation is the figure that has been published widely). The job of mounting the two whiskers as close together as this, so that their tips do not touch each other but still press down upon the germanium surface, is the formidable mechanical obstacle which most experimenters have found.

Recently, Ralph Jacobson, WØYEE, produced a mechanically rugged transistor for the author's experiments, using 1N34 parts. It is the novel, easily duplicated construction of this unit which is described here.

Construction

Fig. 2 is an exploded view, showing how the various parts of a 1N34 have been utilized in construction of the crystal triode.

The 1N34 consists of two threaded brass end plugs which are screwed into opposite ends of a small ceramic tube. The tungsten whisker is soldered to one of these plugs and rests upon the surface of the germanium wafer. The wafer is soldered to the end of a brass pin passed through a central hole in the other end plug and held by a setscrew. These parts are all shown, ready to go together, in Fig. 2. After adjustment at the factory, the ceramic tube is filled with wax. This wax has been injected through a hole in the side of the ceramic tube; this hole served previously for an access point through which the whisker could be moved about to various spots on the germanium surface during electrical adjustment.

After obtaining two 1N34's, the first step in the construction of the triode is carefully to pick out the sealing material which plugs the hole in the ceramic tube of each unit. This may be done with a needle, being cautious not to dig any deeper into the unit than the thickness of the ceramic wall. The next



Five simple tools used in making transistors.

step is slowly to melt out the wax by heating the entire unit. Hold it high over a low flame. Make no attempt to rush this operation. The wax will run out through the side hole. After the wax has been expelled, the tinned ferrules which hold the pigtails may be peeled off the end of each unit with the aid of diagonal cutters. This will expose the two brass end plugs which then may be unscrewed.

After removing the end plugs, unsolder the whiskers from their plugs and bathe them in carbon tetrachloride. The next step requires painstaking care: saw one of the whisker plugs vertically in half, using the thinnest obtainable jeweler's saw blade, to obtain the two separated halves shown as parts A and C in Fig. 2. Solder one whisker to each half. The tungsten wire is a little tricky to solder and may require acid soldering flux. If the latter is used, wash the finished job thoroughly in strong soapy water, give several rinsings in clear water, then dry the parts and bathe them in carbon tetrachloride. Next, using Duco cement, fasten the two halves of the split end together with an insulating separator (part B in Fig. 2) made from Lucite or Plexiglas $\frac{1}{16}$ inch thick. Be careful to keep the threads of the split plug aligned. Then, with a needle, toothpick, or slender tweezers, bend the tips of the whiskers together until they have the smallest separation without actually touching each other. It will help to use both a magnifying glass and continuity meter in this operation.

Screw the two-whiskered plug back into one end of the ceramic tube, and the germanium-holding plug F into the other end. Using a magnifying glass

(or the naked eye if yours is that good), look through the tube hole to see whether the whiskers are both in contact with the germanium surface and also whether threading in the germanium plug has twisted them. If the whiskers are twisted or are touching each other, separate them with a needle or toothpick inserted through the hole. If they are spread too far apart, push them closer together with the needle. If the whisker tips are not in contact with the germanium surface, loosen the setscrew in the germanium end plug and cautiously push the end of the germanium pin inward by means of a pin inserted into the center hole of the plug, until contact is made. Then retighten the setscrew.

The final step is to solder a wire pigtail lead to each half of the split whisker plug (A and C in Fig. 2) and also to the germanium plug F. The soldering operation must be completed quickly in order not to melt the solder holding the whiskers or damage the germanium wafer.

Throughout the construction, take care not to handle the germanium wafer or the whiskers with the fingers any more than is absolutely necessary. If there has been excessive handling, both the whiskers and the germanium wafer should be bathed in carbon tetrachloride or lacquer thinner.

Fig. 3 shows how the completed transistor assembly appears in cross section. Letter symbols are the same as those in Fig. 2. The photographs also show constructional details.

Adjustment

After the unit has been assembled, set up the test circuit shown in Fig. 4, and test the crystal triode according to the following procedure. Either half of the split end plug may be chosen as emitter or collector.

1. With switch S2 open, close switch S1. The emitter current, read with milliammeter M1, should not exceed 20 ma and undoubtedly will be in that neighborhood at the outset.

(The 20-ma emitter current is very much greater than the figures commonly published. These range from a fraction of a milliampere to 1 or 2 ma. Transistors made by different experimenters vary widely for reasons still unknown. The performance of transistors made by readers therefore may be entirely different from that of the one described here; the difference should be no cause for discouragement or alarm but should, instead, prove to be a strong incentive for experimentation.—Editor)

2. Open S1 and close S2. The collector current, read with milliammeter M2, should not exceed 0.5 ma.

3. If emitter or collector current is in excess of the values given, reverse the emitter and collector terminals and repeat steps 1 and 2. If the currents still are excessive, unscrew the germanium end plug, loosen the setscrew, and rotate the germanium pin to expose new surface points to the whiskers. Reinsert the end plug, respace the whisk-

ers if necessary, and repeat the tests.

4. When approximately correct emitter and collector currents are obtained, label the emitter and collector terminals by marking the whisker end of the ceramic tube.

Check the transconductance of the triode in this manner:

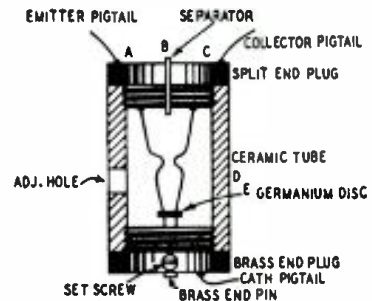

Fig. 3—Cross-section of finished transistor.

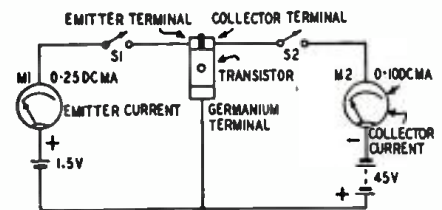

Fig. 4—Test circuit reveals characteristics.

1. Close switch S2 and record the reading of milliammeter M2 as I1.
2. Leaving S2 closed, close S1, noting the new reading of milliammeter M2. Record this second M2 deflection as I2.
3. The transconductance in micromhos is

$$\frac{1,000 (I_2 - I_1)}{1.5}$$

The builder should aim for the highest transconductance he can obtain with a given germanium wafer. Magazine articles have reported transconductances as high as 15,000 micromhos. The author has found that transconductances of 1,000 to 3,000 (comparable to such tubes as the 6J5, 6SQ7, 6T7, etc.) may be obtained readily with little or no adjustment on a transistor of the type described in this article. Rotating the germanium wafer to expose better spots to the two whiskers has yielded transconductances a little higher than 5,000, but the author has not exceeded that figure.

After all adjustments are completed, the side hole in the ceramic tube should be closed with a small piece of Scotch tape. We do not recommend filling the interior of the unit with any of the waxes ordinarily available to the home experimenter.

Some question is apt to arise as to capacitance between the two halves of the split whisker plug. The author checked this and found it to be 2.45 $\mu\mu\text{f}$ in his unit at a test frequency of 1 mc. This is comparable to the grid-plate capacitance in a corresponding triode tube, smaller, in fact, than in such triodes as 6J5, 6SL7, 6SN7, etc. It should cause no trouble.

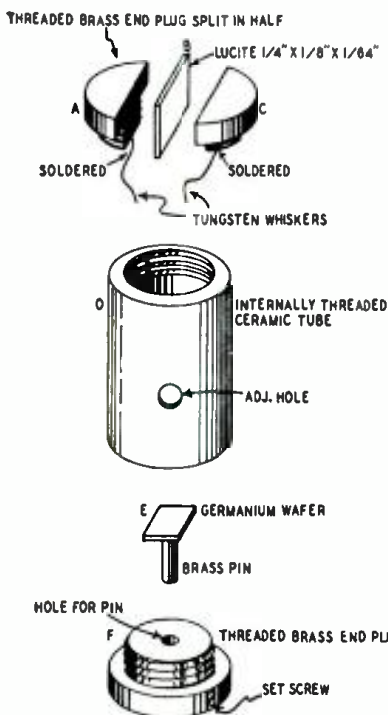

Fig. 2—Exploded view shows transistor parts.



Photoflash Unit For Your Camera

A voltage-doubler saves space and weight in this useful photographer's aid

By W. C. BROWN *

SEVERAL years ago the writer built an electronic flash outfit for his own use. While it gave excellent service, it was far bigger and heavier than necessary, and as time went by the desire for a more convenient unit grew.

No small amount of thinking and innumerable paper sketches finally resulted in a mental picture of what the new unit should be like. Remembering that electronic components are almost always rated for continuous duty and that the duty cycle in electronic flash service is very low, a few rough calculations showed that components with very low ratings were ample. This reasoning even applied to capacitors, although not to the same extent as to transformers, rectifiers, and resistors.

War-surplus components are generally of excellent quality and attractively priced. But they are heavy. All the transformers listed in advertisements and having the desired secondary voltage delivered 100 ma or more. You simply don't carry such a transformer around in your pocket; and since light weight was a requirement, these transformers were ruled out. Further meditation provided more answers: If a light-weight transformer delivering 2,000 volts d.c. at the rectifier output is not available, why not voltage-double from a light-weight, lower-voltage transformer?

A capacitor connected across an unloaded d.c. circuit will charge to the full peak voltage across the circuit, and an unloaded voltage doubler will have exactly $2\sqrt{2}E_{rms}$ across its output. In a photoflash unit previously sketched out, the flashing capacitors also served as part of the voltage doubler so they would charge to twice the transformer

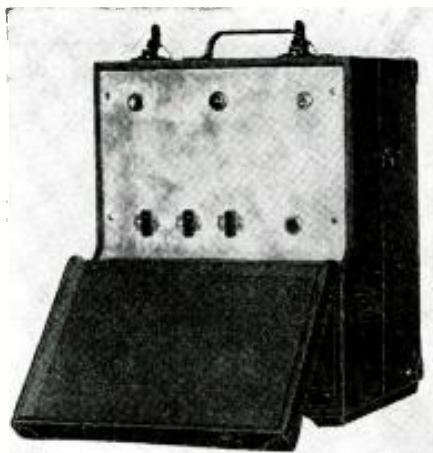

Frequency meter case contains the power supply for the flash unit. Three receptacles for flash guns are shown; the author later added two more, as the circuit diagram shows. The panel is mounted on $\frac{3}{4}$ -inch spacers to make room for the energy-storage capacitors within.

peak secondary voltage. Using a 900-volt transformer this gives $2(1.414 \times 900) = 2,545$ volts.

Now the foregoing is true only where there is no loading on the circuit and the back-resistance of the rectifier is infinite. Neither condition applies in the unit described here; and since the back-resistance of dry-disc rectifiers is relatively low, the voltage across the capacitors in this unit turns out to be only about 2,000. But that is plenty.

If thermionic rectifiers are used, the output voltage will approach the 2,500-volt figure because of their high back-resistance. In such a case, for the welfare of the capacitors, it is suggested that a 700- or, at the most, a 750-volt transformer be used.

Having decided upon a voltage doubler, the next question was the type of rectifier to be used. After considering all the factors of weight, cost, and life, dry-disc rectifiers were selected over

vacuum tubes with the necessary two filament transformers. There is very little choice, however, and two tubes (2X2's) and two filament transformers may be used in place of the dry-disc rectifiers used by the writer. It might be added that the thermionic-rectifier system will cost a little less and weigh a little more than the dry-disc type. The schematic is shown. The next problem was where to obtain the parts. The advertisements of dealers in surplus materials revealed that almost all of the needed components were listed. The writer used two 15- μ f and two 10- μ f capacitors wired to give two 25- μ f units for the energy-storage capacitors. These fit very nicely into the case used. Subsequently, regular 24- μ f photoflash capacitors were found in the surplus market. While these are made for 2,000-volt photoflash service, they have stamped on the case "24 MFD—1500 VDC Work—3000 VDC Peak." The dealers apparently feel that it would be unethical to advertise them for 2,000-volt photoflash service when they are plainly marked for 1,500 working volts. So they won't be found in the adver-

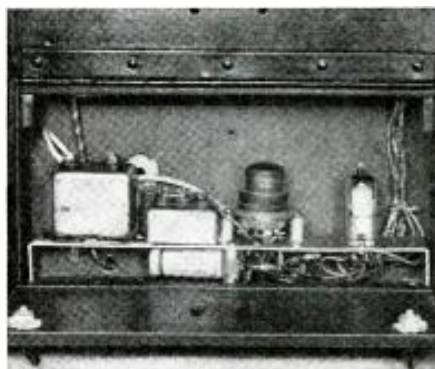

The trigger circuit installed in the lower front compartment of the case. The 6H6 was later replaced with two selenium rectifiers to give enough capacity for five flash tubes.

*Signal Corps Engineering Laboratories, Fort Monmouth, N. J.

tisements as photoflash capacitors, but they are intended for such service and will last for a long time.

The case used was intended for the BC-221 frequency meter. The canvas cover and all internal fittings and hardware except three items were removed. The angle brackets in the upper compartment for mounting the panel were left in, as was the partition separating the upper and lower compartments and the partition separating the lower compartment into two parts. The outside of the case was given a coat of flat black lacquer and waxed when dry. The result was a neat and attractive unit.

The power supply was mounted on a U-shaped chassis and fitted into the large lower compartment. This chassis contains the power transformer, the 10- μ f voltage-doubler capacitor, the rectifier, the 6.3-volt transformer for all heaters and the pilot light, and a terminal strip for connection to the other chassis. The writer fastened the power transformer and the 10- μ f capacitor by using a length of flexible No. 14 wire with spade bolts on each end. This makes a flexible U-clamp, and two of these for each component will hold it very firmly to the chassis. The chassis was held in by drilling and tapping 8-32 holes in the lips of the chassis and then drilling matching holes in the side of the case. Flat-head 8-32 screws were used to hold the chassis positively in place.

The trigger circuit is also mounted on a U-shaped chassis with 1-inch lips. The 2D21 was chosen instead of the 0A5 solely because of cost. The 2D21 and its filament transformer are surplus items, and together cost less than the non-surplus 0A5.

In operation this circuit is simple. The grid of the 2D21 is normally biased beyond cutoff; but when the synchronizing contacts on the camera are closed, the grid is made positive. The tube immediately fires and capacitor C discharges through the tube and the trigger transformer T in the cathode circuit. This pulse in the trigger-transformer primary induces a 12-15-kc pulse in its secondary, which is connected to the flash-tube grid, and causes the flash to fire.

C is, of course, essential, and without it, the circuit won't work. This is due to the high IR drop that would exist across R the instant the 2D21 started to conduct. This drop would be so high that the plate voltage on the tube would immediately drop below the firing voltage when the tube started conducting. C thus provides a low-impedance power source for the 2D21 during the short period of time necessary to generate the trigger pulse. It, of course, recharges between flashes.

The trigger transformers used are model-gas-engine ignition coils. Several manufacturers are now building small transformers for this service and they will serve just as well as the small ignition coils. Shown alongside the main unit schematic is a schematic of one flash-tube unit with its wiring. The

trigger transformer is mounted directly on the back of each reflector.

The plate voltage for the 2D21 could be taken from a voltage divider across the B-supply. This would load the doubler still further and lose a few more volts in the output. With 117-volt, 50-ma selenium rectifiers and electrolytic capacitors as cheap as they are, it was decided to double the 117-volt supply and provide a separate power supply for the trigger circuit. As indicated in the diagram, the trigger circuit will simultaneously fire as many as five flash tubes. The circuit is, of course, a simple voltage doubler; but remember—the selenium stacks are insulated for only approximately 130 volts, and in this circuit voltages as high as 250 appear between the rectifier plates and ground. Be sure to insulate the rectifiers from the chassis when mounting them. Small ceramic standoffs are suggested. The photograph of the trigger circuit components shows the 6H6 originally used; the selenium rectifiers were added later to increase the number of flash tubes that could be triggered.

The four units comprising the 25- μ f energy-storage capacitors (which are also part of the voltage-doubling circuit) are mounted in the upper compartment of the case. We do not know whether two of the regular photoflash capacitors available as surplus will fit in, but one of them definitely will. If two will not fit, the reader can mount one or both right on the light standard. The diagram shows that while only two capacitors are in the circuit, three extra outlets are provided on the panel for remote flash lamps with their own 25- μ f capacitors. This procedure eliminates the IR drop of a long lead to the flash tube and avoids the inductance and capacitance effects of a 10- or 15-foot piece of co-axial cable.

Remember that all exposed high-voltage leads should be of flexible co-axial cable. An insulation breakdown will result only in a short across the

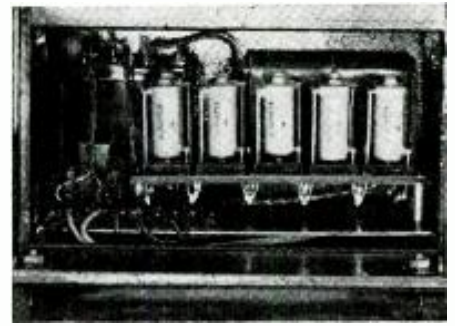

Dry-disc rectifiers in lower rear compartment. output of the unit and never endanger anyone coming in contact with the leads. All wire carrying high voltage within the unit should be made with hookup wire insulated for 5,000 volts.

The photographs show the completed unit in operating condition. Note that the panel is flush with the face of the top compartment. The panel-mounting brackets left in the case will recess the panel if it is mounted directly on them. With the panel recessed, there is not enough clearance between it and the capacitor bank for the panel-mounted components. Using a 1/8-inch aluminum panel, 3/4-inch spacers will bring it exactly flush and provide sufficient clearance for the switch, pilot light, receptacles, and so on.

This equipment has been in use for some time, and its performance equals any seen by the writer from commercial units costing \$150 to \$250. It will handle five lights giving 12,000,000 peak lumens each. And the total cost is less than \$30.00.

- MATERIALS FOR PHOTOFASH UNIT**
 Resistors: 3—100,000, 1—200,000, 2—220,000 ohms, 1/2 watt; 1—750-1,500 ohms, 5 watts.
 Capacitors: 3—8 μ f, 450 volts, electrolytic; 1—10 μ f, 1 kv, oil-filled; 2—25 μ f, 2 kv.
 Tubes: 1—2D21, 1—6H6, 1—GE FT-14.
 Transformers: 1—6.3-volt, 1-ampere; 1—900-volt, 25-ma or equivalent.
 Miscellaneous: 1—model-gas-engine ignition coil; 12—117-volt, 50-ma, dry-disc or selenium rectifiers; 1.5—flash-lamp assemblies; 1—miniature 7-pin tube socket; 1—s.p.s.t. toggle switch; 3—3-connection female, polarized panel receptacles, insulated for high voltage; 1-3—male plugs to fit; 1—6.3-volt pilot-lamp assembly; 1—case; necessary hardware.

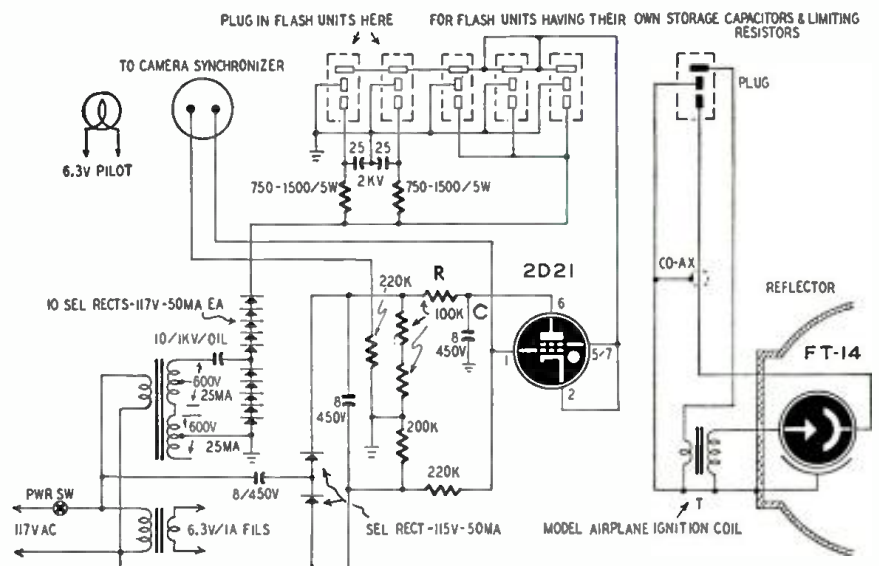

Complete schematic diagram of the flash unit. Use high-voltage cable for ignition circuits.

Telephone Lines in Broadcasting

By LEIGH L. KIMBALL*

Part II — Maintenance, attenuation, noise, and communication problems

THE first part of this article (April issue) explained methods of equalizing telephone lines used for carrying broadcast programs. The broadcast engineer must also be familiar with the techniques of measuring noise and loss on these lines and with maintenance procedures.

Line loss depends on loop makeup (sizes of wires used), equalization applied, and length. It is more easily measured than calculated. It is also affected by line terminal impedance, which may or may not be equal to the input and output impedances of the loss-measuring equipment. Therefore, a definition of line loss which takes operational mismatch into account must be used. It is as follows for 600-ohm program equipment:

The difference between the reference power level which a generator of 600 ohms internal resistance will deliver to a 600-ohm resistive load, and the level received in a 600-ohm measuring set at the line output terminals when the generator is connected to the line input terminals, is the line loss.

Note that any impedance mismatches are conveniently taken care of by such a definition. It is important to eliminate impedance mismatch as a factor in loss measurement because line terminal impedances vary widely. The arrangement used for frequency-response measurement (Fig. 2 in April article) is also ideal for loss measurement. The measuring set may simply be a calibrated amplifier used for presetting programs.

Noise

All telephone lines are subject to a certain amount of induced cross-talk interference. Cross talk may come from several sources—dial systems, teletype machines, tone and d.c. telegraph, special high-frequency ringing systems, and faulty voice circuits, to list a few. Objectionable hum on the line is usually an indication of an unbalance or a long, unterminated branch somewhere in the circuit.

Unusually long lines are, of course, especially subject to cross talk. As the audio signal travels down a long line, it may be attenuated to a relatively low level. However, the induced noise tends

to remain more or less constant along the line. The result may be a small signal-to-noise ratio. To combat this situation, the highest permissible power level should always be delivered to the line. The maximum levels which have been agreed upon¹ are:

Program material 8 VU
Sustained test tones 0 VU
400- or 500-cycle tone for program level setting 8 VU
 (VU=db above 1 mw.)

The +8-VU level for program transmission has been set as high as possible to give the broadcaster the best signal-to-noise ratio consistent with proper cross-talk protection to other services handled through the telephone exchanges.

Other solutions are available to the broadcast engineer having trouble with line noises. An audio booster or repeater amplifier may be installed at an intermediate point on the line to restore the program level before it drops down into the noise. Where the line length is not excessive, but noise is giving trouble, it may be necessary to move the radio-loop pair to another point in the telephone cable (or cables) of which it is a part. The usual practice is to move it 25 pairs away from the point where it is giving trouble.

The VI pad

An attenuation pad is not necessary between the amplifier and the line to maintain frequency response; it would have absolutely no effect on the over-all response if the pad were the same as the amplifier's internal impedance.

However, the pad is necessary to make the volume indicator at the line input read accurately and to provide the correct meter damping on program material. The damping factor is especially important when several V.I.'s in a system must be co-ordinated. An attenuation pad between the amplifier and line as shown in Fig. 1 will reduce V.I. error which could result from connecting the V.I. directly across the line. This is important because telephone-line terminal impedances vary over a wide range and the standard V.I. is designed to have the proper damping and power calibration when connected across an amplifier and load, both of which have an impedance of 600 ohms. The pad is

also extremely important if a bridging amplifier is connected across the output of the line amplifier, as line capacitance will probably reduce the high-frequency output of the line amplifier even if the line is perfectly equalized at the far end. The capacitance effect at the sending end can be eliminated from the bridging amplifier by isolating the line by means of a 600-ohm pad. A 6-db pad usually gives sufficient isolation to make the amplifier load look like 600 ohms over the audio range, but 8 to 10 db may be desirable when equalizing by method 1 in Fig. 6 of the April article, in which case the input impedance of the line may be several thousand ohms at medium audio frequencies. However, excessive attenuation only increases amplifier distortion if the correct power level to the line is maintained.

Telephone communication

Communication between the remote point and the studio is essential for program production. There are several ways of maintaining it. Telephone com-

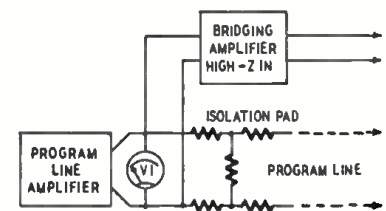

Fig. 1—Isolating pad for volume indicator.

munication may be carried on *via* the program loop itself. This is certainly desirable economically, and is often sufficient for small stations. Modern control consoles of the type usually employed by small stations have elaborate provisions for talk-back and cueing to remote points, and these should be used whenever possible.

When a greater degree of reliability and flexibility is required, a PL (private line) to the remote point may be hired to parallel the program loop. The PL may be another loop of the same high quality as the radio circuit, or it may be (and usually is) a less expensive line designed primarily for telephonic communication. In the latter case, there may be loading coils left in the line, but even so, the PL will put the show on the air (which, after all, is the main

* Chief Engineer, WASH-FM.

Coupling Capacitors Can be Troublemakers

By JOHN T. BAILEY

commercial consideration) should the regular program loop fail.

Several telephone arrangements are possible for PL work, and the best one depends upon the individual case.

Line maintenance

Certain procedures of routine line maintenance will pay big dividends as program insurance.

1. An early-morning check of all lines which will be used during the day.
 - a. Resistance and noise check is sufficient on most lines. In this case, all lines are permanently terminated in 100,000 ohms, used only for the resistance check.
 - b. A round-robin check is most satisfactory when a one-way amplifier has been installed on the program line at an intermediate exchange because of extreme line length. In this case, the PL and radio circuits must always be connected together by the remote operator after finishing his program. A standard tone or program material may then be fed down the PL from the studio to return *via* the program loop.
2. A complete check of frequency response, loss, and noise should be made on all lines once a month, especially those lines which are seldom used but may be called up on short notice. A calibrated amplifier or standard transmission set is invaluable in making these checks.



Fig. 2—Form for telephone line information.

3. Loop numbers are very important to the broadcast engineer. They should always be obtained at the time of line installation, as the loop number designates the whole circuit in the records of the telephone company. Should there be trouble on a circuit, the Wire Chief in the first exchange on the faulty loop should be called. The first piece of information he will require is the *loop number*. As some lines may pass through several exchanges, any information about a line is very helpful in an emergency. A sample form page for keeping line records is shown in Fig. 2. One such page should be kept for each line; the result will be a whole notebook full of valuable information.

MANY readers may have wondered why the writer felt it necessary to include a 200-megohm range in the novel ohmmeter described in the April issue of RADIO-ELECTRONICS. There are many important reasons why no modern service shop is complete without such a high-range instrument.

In present-day circuits 10-megohm resistors are commonly used as grid resistors in low-level audio stages, with tubes such as the 12SQ7, 12AT6, and many others. The resistors develop bias, and they cannot be measured without a high-range meter. Even higher-value resistors are used for grid bias in hearing-aid and subminiature-tube circuits.

Probably the most extensive use of a 200-megohm range is for checking d.c. leakage resistance of capacitors other than the electrolytic types. A good paper capacitor will have a resistance above 300 megohms, though in many applications a lower resistance is immaterial. However, there are numerous instances where high resistance is required.

Coupling between audio stages is one important instance, as shown by C in Fig. 1. This capacitor sometimes gets fouled with dust and dirt and develops a low resistance over its exterior surface. Extremes of temperature as encountered in auto radios cause expansion and contraction of the inside foils and eventually low-resistance paths, besides other defects. Since these coupling capacitors have high d.c. potentials across them at all times, they act as bleeders when low in resistance and divert small currents through the following stage's grid resistor, thus producing a voltage opposite in polarity to that stage's grid bias. Hence, the following stage's grid bias is reduced and more plate current flows, causing the tube to operate under incorrect conditions. Many a tube has gone soft and had to be replaced because of a leaky capacitor coupling its grid to the plate of a preceding stage.

Furthermore, the increased plate current causes the tube to operate at a higher temperature and this increases the amount of grid current flowing, which also reduces the negative grid bias. Therefore, when using output tubes such as the 25L6, 50L6, 117P6, and so on, a low-value grid resistor is

recommended to limit the undesirable accumulated voltages developed by the faults just mentioned.

Another capacitor which has no plate voltage across it, but which can cause plenty of trouble, is the coupling capacitor C in Fig. 2, from the volume-control tap to the grid of a 12SQ7 tube in a typical diode-detector-a.v.c.-first-audio circuit. When this capacitor's resistance drops, even if it is no lower

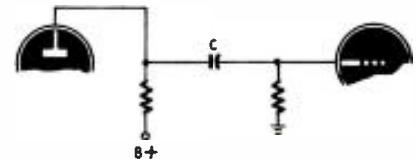

Fig. 1—Capacitor C becomes voltage divider.

than 50 or 75 megohms, the set will overload on strong signals. This is because the volume control will have an a.v.c. potential of possibly -25 volts d.c. across it on a strong signal. This 25 volts is shunted by the leaky capacitor of, say, 50 megohms in series with the following tube's grid resistor of 10 megohms, with the grid connected to the common junction. Hence, the grid gets a negative bias equal to $\frac{1}{6}$ of 25 volts ($10/10 + 50 = \frac{1}{6}$) which is sufficient to cut off the plate current of a high-mu triode.

A word of advice: check all coupling capacitors with a *high-range* ohmmeter and replace all which test under 100 megohms. It is amazing how many capacitors in midget sets have low re-

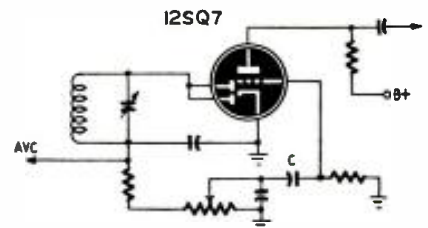

Fig. 2—Troubles start when C gets leaky.

sistance values. And how the distortion can be cleaned up and the output increased by replacing them! But don't expect to find these offenders with an ohmmeter range of less than about 200 megohms because 100 megohms, even on a 200-megohm range, is in the crowded portion of the scale.

Survey of Multitesters

By RUFUS P. TURNER
and
ROBERT F. SCOTT



The Mickok Model 435 measures a. c. at 5,000 ohms per volt.

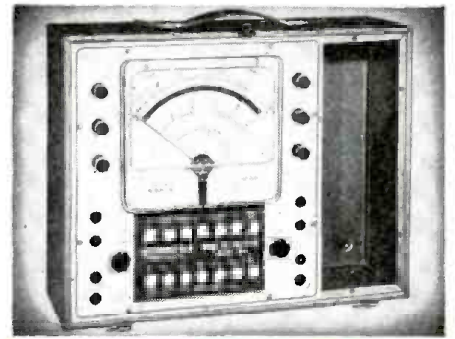

Supreme 644, a deluxe instrument with 98 different ranges.

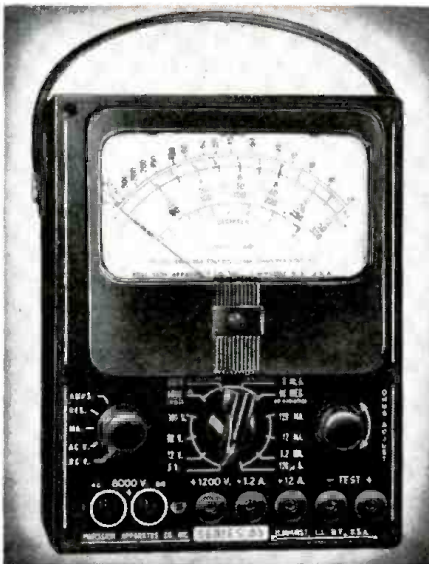

The Precision Series 85 is a good all-purpose instrument.



The Model 630 (Triplet) measures currents as low as 1 μ a.



Superior's Model 670 is popular with radio service technicians.

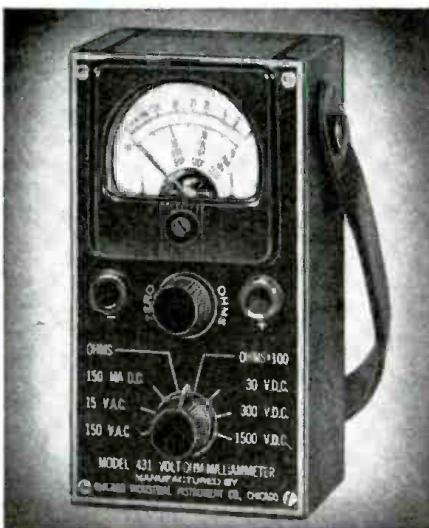

A low-cost meter is Chicago Industrial Instrument's 431.



Popular with hams and service technicians — the Simpson 260.



A common sight on many service benches is Radio City's 488.

Electrical specifications of popular multimeters—still the most valuable radio service instruments

THE nonelectronic volt-ohm-milliammeter, commonly called the "v.o.m.," long has been considered the foundation instrument for all radio test benches. This meter is the basic test tool which the new radioman buys first and is apt to use more frequently than any other piece of gear in the shop. It is versatile and can be used under a variety of work conditions. It is especially long-lived—as long as the user does not set it on the 10-ma range and put 100 volts across it!

Modern volt-ohm-milliammeters provide a.c. and d.c. voltage coverage sufficient for all usual receiver and transmitter measurements. The average resistance range is somewhat better than in pre-war models. Very nearly all the new meters check d.c. amperes, as well as milliamperes and—in some cases—microamperes. Only a few measure a.c. milliamperes and amperes, but this is not ordinarily necessary in radio servicing.

The prices range somewhat higher than in earlier models. (The average

price of thirty current models is \$39.)

The accompanying table lists information on most of the popular models. Technicians can use the data for guidance in selecting a new meter.

SYMBOLS

- *—Alternating current ranges
- 1—Resistance range can be extended with external batteries
- 2—Same ranges available at 1,000 ohms/volt
- 3—1.2-, 30-, 60-, and 120-ohm external shunts available
- 4—1-, 5-, 10-, 25-, 50-, 75-, and 100-ampere shunts available
- 5—25-, 50-, 75-, and 100-ampere shunts available
- 6—Meter has output ranges same as the a.c. volts ranges

Manufacturer and Model	D.c. volts	A.c. volts	Direct current	Resistance	Other functions	Case (in.) weight	Scales	Control
Chicago Industrial Instrument Company Model 421 ⁶	0-7.5-15-150-750-1,500 1,000 ohms/v	0-7.5-15-150-750-1,500 1,000 ohms/v	0-7.5-75 ma	0-5k-500k ohms		H: 5 ⁷ / ₁₆ W: 3 ⁹ / ₁₆ D: 3 4 lbs	3 2.2 in.	toggle switch; jacks
Model 431	0-30-300-1,500 2,000 ohms/v	0-15-150-1,000 ohms/v	0-150 ma	0-3k-300k ohms		H: 5 ⁵ / ₁₆ W: 2 ¹³ / ₁₆ D: 2 ¹ / ₂ 4 lbs	3 1.6 in.	rotary switch; jacks
Model 450A	0-5-10-50-100-500-1,000 1,000 ohms/v	none	0-1 ma	0-5k-50k-500k ohms		H: 3 ⁵ / ₁₆ W: 2 ⁷ / ₈ D: 2 ¹ / ₂ 12 oz	2 1.7 in.	rotary switch; jacks
Model 458	0-5-10-50-500-2,000 1,000 ohms/v	0-12.5-25-125-250-1,250 1,000 ohms/v	0-1-10-100 ma; *0-2.5-25-250 ma	0-1k-200k ohms; 0-2 megohms	-5 to +55 db	H: 10 ¹ / ₈ W: 6 ³ / ₄ D: 5 ¹ / ₂ 8 lbs	5 3.1 in.	rotary switch; jacks
General Electric Company Model UM-3	0-2.5-10-50-250-1,000-2,500 2,000 ohms/v	0-2.5-10-50-250-1,000-2,500 1,300 ohms/v	0-1-10-100 ma; 0-1-10 amps	0-1k-100k ohms; 0-1 megohm ¹	-12 to +55 db (5 ranges)	H: 9 W: 10 D: 4 ⁵ / ₈ 9 ¹ / ₄ lb	5	rotary switch; jacks
Model YMW-1A ⁶	0-2.5-10-50-250-1,000 20,000 ohms/v	0-2.5-10-50-250-1,000 1,000 ohms/v	0-50 μa; 0-0.5-5-50-500 ma	0-2k-200k ohms; 0-20 megohms	-4 to +62 db (5 ranges)	H: 10 ¹ / ₄ W: 9 ³ / ₄ D: 4 9 lbs	5 4 ¹ / ₂ -in. meter	rotary switch; jacks
Hickok Electrical Instrument Company Model 435 ⁶	0-2.5-10-50-250-1,000-5,000 20,000 ohms/v	0-2.5-10-50-250-1,000-5,000 5,000 ohms/v	0-50 μa; 0-2.5-10-50-250 ma; 0-1 amp	0-10k-100k ohms; 0-1-10 megohms	-30 to +55 db (5 ranges)	H: 6 W: 8 ¹ / ₄ D: 4 ¹ / ₄ 6 ¹ / ₂ lb	5	rotary switch; jacks
Precision Apparatus Company, Inc. Series 40 ⁶	0-3-12-60-300-1,200-6,000 1,000 ohms/v	0-3-12-60-300-1,200-6,000 1,000 ohms/v	0-0.6-6-60-600 ma	0-5k-500k ohms; 0-5 megohms	-26 to +70 db (6 ranges)	H: 6 ¹ / ₄ W: 3 ³ / ₄ D: 2 ¹ / ₂	4 3-in. meter	rotary switch; jacks
Series 80 ⁶	0-6-12-60-300-1,200-6,000 1,000 ohms/v	0-6-12-300-1,200-6,000 1,000 ohms/v	0-0.6-6-60-300 ma; 0-1.2-12 amps	0-1k-100k ohms; 0-1-10 megohms	-20 to +70 db	H: 7 ¹ / ₈ W: 5 ¹ / ₂ D: 3	4 4 ⁵ / ₈ -in. meter	rotary switch; jacks
Series 85 ⁶	0-3-12-60-300-1,200-6,000 20,000 ohms/v	0-3-12-60-300-1,200-6,000 1,000 ohms/v	0-120 μa; 0-1.2-12-120 ma; 0-1.2-12 amps	0-6k-600k ohms; 0-6-60 megohms	-26 to +70 db	H: 7 ¹ / ₈ W: 5 ¹ / ₂ D: 3	4 4 ⁵ / ₈ -in. meter	rotary switch; jacks
Series 847-P ⁶	0-3-6-12-60-300-600-1,200-6,000 5,000 ohms/v	0-3-6-12-60-300-600-1,200-6,000 1,000 ohms/v	0-0.3-1.2-3-30-300-600 ma; 0-1.2-12 amps	0-2k-20k-200k ohms; 0-2-20-200 megohms		H: 8 ¹ / ₂ W: 7 ¹ / ₂ D: 3	4 4 ⁵ / ₈ -in. meter	P.B. switch; jacks
Series 858-P ⁶	0-3-6-12-60-300-600-1,200-6,000 20,000 ohms/v	0-3-6-12-60-300-600-1,200-6,000 1,000 ohms/v	0-60-120 μa; 0-1.2-12-120-600 ma; 0-1.2-12 amps	0-6k-60k-600k ohms; 0-6-60-600 megohms	-26 to +70 db	H: 9 W: 10 D: 4 ¹ / ₂	4 4 ⁵ / ₈ -in. meter	P.B. switch; jacks
Series 866	A panel-mounting instrument with electrical specifications of Series 847-P. 9-inch meter and controls on 19-inch panel.							

Manufacturer and Model	D.c. volts	A.c. volts	Direct current	Resistance	Other functions	Case (in.) Weight	Scales	Control
Radio City Products Model 447A ⁶	0-5-50-250-500- 2,500 1,000 ohms/v	0-10-100-500- 1,000 1,000 ohms/v	0-1-10-100 ma; 0-1-10 amps	0-10k ohms; 0-1 megohm ¹	-8 to +55 db	H: 5 ⁷ / ₈ W: 8 ⁵ / ₈ D: 3 ¹ / ₈ 2 ³ / ₄ lbs	4 3-inch meter	rotary switch; jacks
Model 449 ⁶	0-5-50-250- 1,000 5,000 ohms/v	0-5-50-250- 1,000 1,000 ohms/v	0-0.5-50-250 ma; 0-1 amp	0-2k-20k-200k ohms; 0-2 megohms	-6 to +52 db	H: 6 W: 3 D: 2 ¹ / ₄ 2 lbs	4 3-inch meter	jacks
Model 488A ⁶	0-3-12-60-300- 600-1,200-6,000 20,000 ohms/v	0-3-12-60-300- 600-1,200- 6,000 1,000 ohms/v	0-60-300 μ a; 0-3-20-120-600 ma; 0-12 amps; *0-3-6-12 amps	0-3k-300k ohms; 0-30 megohms		H: 11 ⁵ / ₈ W: 9 ³ / ₄ D: 6 ¹ / ₈ 10 lbs	4 4 ¹ / ₂ -in. meter	rotary switch; jacks
Simpson Electric Company Model 221 (Roto-Ranger)	0-2.5-10-50- 250-1,000-5,000 20,000 ohms/v	0-2.5-10-50- 250-1,000- 5,000 1,000 ohms/v	0-100 μ a; 0-10-100-500 ma; 0-10 amps	0-2k-200k ohms; 0-20 megohms	-10 to +52 db	11 ¹ / ₂ lbs		rotary switch; jacks
Model 240	0-15-75-300- 750-3,000 1,000 ohms/v	0-15-150-750- 3,000 1,000 ohms/v	0-15-75-300- 750 ma	0-3k-300k ohms		H: 5 ⁷ / ₈ W: 3 D: 2 2 ¹ / ₂ lbs	3 3-inch meter	rotary switch; jacks
Model 260 ⁶	0-2.5-10-50-250- 1,000-5,000 20,000 ohms/v	0-2.5-10-50- 250-1,000- 5,000 1,000 ohms/v	0-100 μ a; 0-10-100-500 ma; 0-10 amps	0-2k-200k ohms; 0-20 megohms	-10 to +52 db (5 ranges)	H: 7 W: 5 ¹ / ₄ D: 3 ¹ / ₈ 3 ¹ / ₂ lbs	5 4 ¹ / ₂ -in. meter	rotary switch; jacks
Supreme Instruments Corp. Model 542 ⁶	0-6-50-150- 300-1,500 5,000 ohms/v	0-6-30-150- 600 5,000 ohms/v	0-0.3-6-30-150 ma	0-2k-20k-200k ohms; 0-2 megohms	-6 to +50 db (4 ranges)	H: 5 ⁷ / ₈ W: 3 ¹ / ₈ D: 2 ¹ / ₈ 2 lbs	3 3-inch meter	slide switch; jacks
Model 632 ⁶	0-5-25-100-250- 500-1,000- 5,000 1,000 ohms/v	0-5-25-100- 250-500-1,000- 5,000 1,000 ohms/v	0-5-25-100-250- 500 ma; 0-1 amp	0-2k-20k-200k ohms; 0-2-20 megohms	-10 to +49 db (5 ranges); 0.1 to 400 μ f	H: 11 ³ / ₄ W: 8 ¹ / ₂ D: 4 ³ / ₄	5	rotary switch; jacks
Model 640 ⁶	0-5-25-100-500- 1,000-5,000 20,000 ohms/v ²	0-5-25-100- 500-1,000-5,000 1,000 ohms/v	0-100 μ a; 0-10-100-500 ma	0-2k-200k ohms; 0-20 megohms	-10 to +49 db (4 ranges)	H: 7 ¹ / ₂ W: 5 D: 3	4 4-inch meter	rotary switch; jacks
Model 644 ⁶	0-5-25-100-500- 1,000-5,000 20,000 ohms/v ²	0-5-25-250- 500-1,000-5,000 1,000 ohms/v	0-5-25-100-500 ma; 0-1-10-50 amps; *0-1-10-50 amps	0-0.5-5-500- 5k-500k ohms; 0-5-50 meg- ohms	-10 to +69 db (6 ranges)	H: 11 W: 15 D: 6 ³ / ₄	4 7-inch meter	P.B. switch; jacks
Superior Instruments Company Model 670 ⁶	0-7.5-15-75- 150-750-1,500- 7,500 1,000 ohms/v	0-15-30-150- 300-1,500-3,000 1,000 ohms/v	0-1.5-15-150 ma; 0-1.5 amps	0-500-100k ohms; 0-10 megohms	-10 to +58 db; .001 to 4 μ f; 1.75 to 8,000 henries	H: 7 ¹ / ₂ W: 5 ¹ / ₂ D: 3	7	rotary switch; jacks
Model 770	0-7.5-15-75-150- 750-1,500 1,000 ohms/v	0-15-30-150- 300-1,500 1,000 ohms/v	0-1.5-15-150 ma; 0-1.5 amps	0-500 ohms; 0-1 megohm		H: 5 ⁷ / ₈ W: 3 ¹ / ₈ D: 2 ¹ / ₄	3	rotary switch; jacks
Triplet Electrical Instrument Company Model 625-NA ⁶	0-1.25-5-25-125- 500-2,500 20,000 ohms/v; 0-2.5-10-50-250- 1,000-5,000 10,000 ohms/v	0-2.5-5-10-50- 250-1,000-5,000 10,000 ohms/v	0-50 μ a; 0-1-10-100 ma; 0-1-10 amps (all ranges at 250 mv) ⁵	0-2k-200k ohms; 0-40 megohms	-30 to +70 db (6 ranges)	H: 5 ¹ / ₂ W: 6 D: 2 ¹ / ₈ 3 lbs	4 (mirror) 6-inch meter	rotary switch; jacks
Model 630 ⁶	0-3-12-60-300- 1,200-6,000 20,000 ohms/v	0-3-12-60-300- 1,200-6,000 5,000 ohms/v	0-60 μ a; 0-1.2-12-120 ma; 0-12 amps (at 250 mv) ³	0-1k-10k ohms; 0-1- 100 megohms	-30 to +70 db	H: 7 ¹ / ₂ W: 5 ¹ / ₂ D: 3 ³ / ₄ 4 lbs	5 5 ¹ / ₂ -in. meter	rotary switch; jacks
Model 666-HH	0-10-50-250- 1,000-5,000 1,000 ohms/v	0-10-50-250- 1,000-5,000 1,000 ohms/v	0-50 μ a; 0-10-100-500 ma; 0-10 amps (at 250 mv) ⁴	0-2k-400k ohms		H: 5 ⁷ / ₈ W: 3 ¹ / ₈ D: 2 ¹ / ₈ 1 lb	3 3-inch meter	rotary switch; jacks
Model 2405-A ⁶	0-10-50-250- 500-1,000 20,000 ohms/v	0-10-50-25- 500-1,000 1,000 ohms/v	0-50 μ a; 0-1-10-50-250 ma; 0-10 amps *0-500 ma; 0-1-5-10 amps	0-4k-40k- ohms; 0-4- 40 megohms	-10 to +55 db (5 ranges)	H: 10 W: 10 D: 5 ³ / ₄ 11 lbs	4 6-inch meter	rotary switch; jacks
Weston Electrical Instrument Company Model 772	0-2.5-10-50-250- 1,000; 20,000 ohms/v ²	0-2.5-10-50- 250-1,000 1,000 ohms/v	0-0.1-1-10-50- 250 ma; 0-1-10 amps	0-3k-30k ohms; 0-3- 30 megohms	-14 to +54 db (5 ranges)			

Novel Bridge Rectifier Circuit

by H. B. CONANT *

FOR many years, two-section instrument rectifiers have been used with two resistors in a bridge circuit to produce full-wave rectification. To my knowledge, however, no one has ever suspected that a *single*-section rectifier and *three* resistors could also be made into a full-wave rectifier.

Thinking about rectifier circuits in general one day, I found myself considering the single-rectifier, three-resistor scheme. I drew the diagram shown here.

Because current relationships in bridge circuits are complex, I omitted the meter at first and calculated the potential difference developed between points B and D during each alternation. According to theory, if a potential difference exists and a meter is connected between two points, current must flow through the meter.

A value of 1,000 ohms was given to each resistor. The resistance of the rectifier was taken as 200 ohms in the forward direction and 30,000 ohms in the inverse direction. An a.c. voltage is applied to terminals A and C. For clarity of explanation, consider this to be 10 volts and terminal A to be the reference or "ground" point of the circuit throughout the discussion.

Taking the first alternation, during which terminal A may represent the negative and terminal C the positive side of the input signal, terminal D has a potential of +5 volts because R2 and R3 are equal. Since current is passing through the rectifier in the forward direction, its resistance is effectively 200 ohms. The voltage at terminal B is then $\frac{200 \times 10}{1,000 + 200} = +1.67$ volts. Obviously, terminal D (at +5 volts) is more positive than terminal B with respect to the reference point, terminal A. The voltage difference between terminals B and D is 3.33 volts. No matter what the a.c. input voltage, terminal D, on this alternation, will always be 33.3% of the input voltage *more positive than terminal B*.

Now let us consider the opposite alternation. This time terminal C is negative and A is positive. Terminal A is still the zero reference point to which all voltages are referred.

Again D is at 5 volts, but this time it is *negative* with respect to A. Since the inverse resistance of the rectifier is 30,000 ohms, the voltage at terminal B is now $\frac{30,000 \times 10}{30,000 + 1,000} = -9.67$ volts with respect to terminal A. With terminal D at -5 volts, terminal B is ob-

viously much more negative than D. In other words D is *still positive with respect to B!* The difference is 4.67 volts, meaning that, on this alternation, D will always be 46.7% of the input voltage more positive than B.

The voltage differences between B and D on the two alternations, as has been shown, are not alike—46.7 volts in one case and 33.3 volts in the other. This will, of course, give a distorted rectified d.c., but the interesting point is that the d.c. is actually greater when current is passing through the rectifier in the *inverse* direction. The same d.c. can be obtained on both alternations if the values of the resistors are changed appropriately.

After all these calculations were made, an actual circuit was connected up and the output of terminals B and D was fed to a 'scope. The full-wave pulsating d.c. showed up clearly, with alternate half-waves slightly different in height.

Next a 1-ma meter was connected across B and D, as shown by dotted lines in the diagram. A sensitivity of 400 ohms per volt was obtained.

Further calculations showed that for optimum results R1 should be equal to 12 times the rectifier's forward resistance, and R2 and R3 should be five times the rectifier resistance.

Two important apparent advantages are: No inverse current can flow through the meter (this is not the case

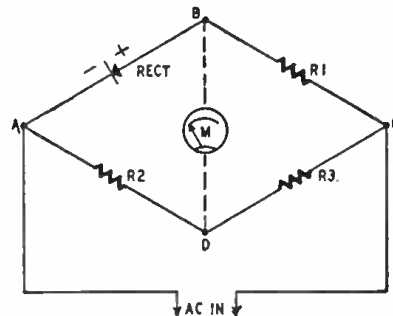

This bridge operates with just one rectifier.

with a four-rectifier bridge), and the rectifier is so placed that damaging it with voltage overloads is extremely unlikely.

(The only possible objection to this ingenious circuit is that its resistance will undoubtedly be higher than that of a four- or even two-rectifier arrangement. It is, of course, less sensitive. These points may or may not be important in any particular application.—*Editor*)



*Conant Electrical Laboratories, Lincoln, Nebraska

Radio Set and Service Review



This 21½-pound recorder is well-balanced and easy to carry.

**The Air King A725
wire recorder has
many applications**

THE development and production of low-cost wire recorders has done much to popularize the use of these devices in business, industry, schools, and homes. Most of the machines can record for periods up to an hour on a single spool of wire so the number of applications is limited mainly by the imaginations of the users.

Invalids, shut-ins, and other persons who would normally have "pen pals" have begun to use wire recorders as a means of communication. They record their messages on spools of wire and mail them to the addressee. After playing the recording on his machine, the addressee erases the wire and records his own message before returning the spool. This method of communication has become so popular in some circles that the word *wiresponding* has been coined to mean communication by magnetic wire.

Many shut-ins find wire recordings have a much more personal touch and are less tiring than writing letters, so the use of wire recorders has enabled them to enlarge their circle of friends. There are some shut-ins who, unable to leave their homes, have a friend or member of their family take the wire recorder to various parties, banquets, and other festive occasions. The recorder is set up in some out-of-the-way place and the microphone placed where it will have the greatest pickup. In this way, the shut-in is able to gather from the recordings much more of the festive gaiety and feeling than he possibly could from a verbal report.

The new Air King Model A725 wire recorder, designed for home and semi-professional use, is one of the few complete units costing less than \$100.00 (slightly more west of the Rockies). It handles standard spools of wire for recording up to 1 hour. The wire speed

is approximately 2 feet per second for recording and playback. The rewind ratio is about 6 to 1.

There are only three controls. They are the combined volume control and on-off switch, the RECORD-PLAY switch, and the SELECTOR switch. The recorder is equipped with a hand-held crystal microphone with a 10-foot cable that plugs into the center of the control panel (see front-view photograph). A jack on the left side of the panel is for connecting a radio tuner, phonograph, or other high-level signal source. A neon recording-level indicator is on the right side of the panel. It operates when the machine is recording. The SELECTOR in the upper right-hand corner controls the speed and direction of the wire during record, playback, and rewind operations by varying the ratio of the friction-drive drums in the mechanism. The SELECTOR is coupled to two slide switches; one applies power to the drive motor in the PLAY, RECORD, and REWIND positions. The other turns on the bias-erase oscillator when the selector is in the RECORD position. A simple press-to-release lock prevents the operator from unintentionally throwing the selector to RECORD while playing a record.

The circuit of the recorder appears in Fig. 1. It consists of a 1280 (non-microphonic 14C7) microphone amplifier, 6AQ6 voltage amplifier, and two 50L6-GT's as power amplifier and oscillator.

The unit has an interesting compensating circuit that attenuates the bass during recording and attenuates the highs during playback. This circuit and that of the level indicator are shown in Fig. 2. The RECORD-PLAY switch S1 is a 6-circuit, 2-position unit. Three of its sections are used in the circuit of Fig. 2. In RECORD, the voice coil (terminals 2 and 4 on the recording head) is capaci-

tance-coupled to the plate of the 50L6-GT power amplifier through C9 and R13. C9, R13, and the low-impedance voice coil form a voltage divider with the maximum voltage being developed across the voice coil at the higher frequencies.

In the PLAY position, one section of S1 grounds C9 through R13 while another section shunts C8 across R13, reducing the high-frequency response.

The level indicator is biased almost to the ignition point by a voltage developed across R11 when S1 is set to RECORD. Audio voltage from the power amplifier is sufficient to make the lamp light on modulation peaks when the volume control is set to the correct level. The lamp is shorted by a section of S1 on PLAY.

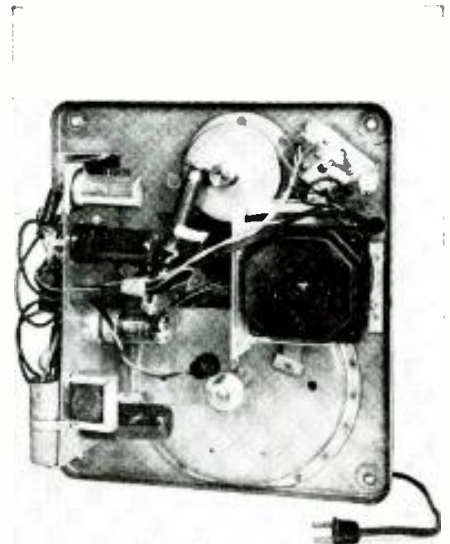

A view of the chassis and driving mechanism.

When S1 is in the RECORD position, it also:

1. Disconnects the loudspeaker and loads the secondary of the output transformer T1 with a 3.2-ohm dummy-load resistor;
2. Connects the microphone to the input of the 1280;
3. Completes the cathode return of the 50L6-GT oscillator through S5 (when the selector is rotated to RECORD);
4. Grounds one side of the output winding of the oscillator transformer T2 to complete the path to the erase and bias coil (terminals 2 and 3) in the recording head.

When the recorder is used for playback, S1, in addition to the functions mentioned, also:

1. Connects the voice coil of the speaker to the secondary of output transformer T1;
2. Connects the voice-coil in the recording head to the input of the 1280 voltage amplifier;
3. Opens the cathode circuit of the 50L6-GT oscillator.

This recorder is easy to thread and simple to operate. One of the most annoying characteristics of it—and other wire recorders—is that the wire tends to break at the slightest provocation. When it does, it is likely to tangle and kink badly. In such cases, it is difficult to gather the loose ends of the wire and tie them without getting more knots and kinks into the wire. An automatic shut-off S3 stops the motor at the end of the play, record and rewind operations but does not operate when the wire breaks.

The quality of reproduction is by no means high but is suitable for many purposes. Amateur radio operators can make records of rare dx contacts and play them for skeptical visitors and members of the local radio club. Par-

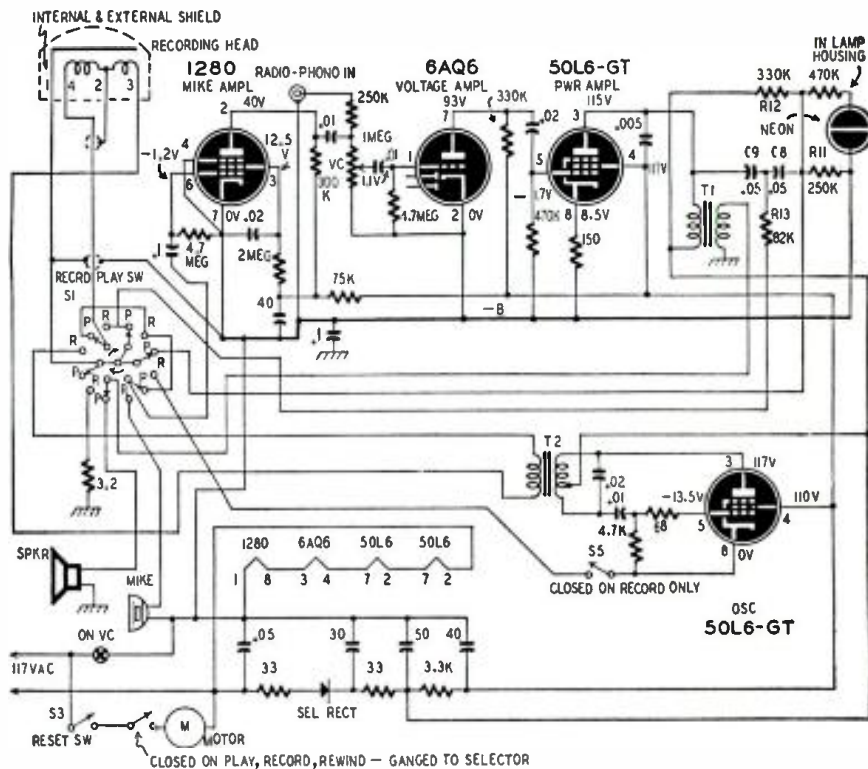

Fig. 1—The circuit of this recorder is simple when compared to some professional models.

ents sometimes find it difficult to get children to study their lessons when study-hours conflict with a favorite broadcast. These parents can record the programs and permit the children to play them at a more convenient time.

The A725 uses a transformerless power supply with one side of the line and B-minus connected to the chassis through a 0.1- μ f capacitor. Although there is no direct connection between the line and chassis, the chassis is hot when the ungrounded side of the line is connected to B-minus.

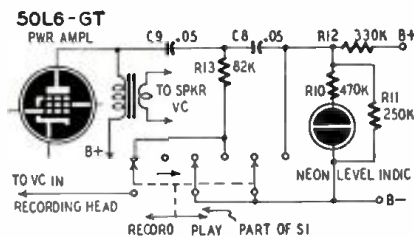

Fig. 2—A novel tone-compensating network.

SERVICE NOTES ON SOME PHILCO SETS

By W. G. ESLICK

Here are some hints for technicians on repairing and improving several frequently encountered models of Philco receivers.

Models 46-1201, 1203, 48-1253, 1260: Replace the oscillator coil with one not having a capacity winding. Use a 47- μ f capacitor between the coil and the 7A8 oscillator grid. Shunt a 10- μ f negative-temperature-coefficient capacitor across the oscillator tuning capacitor.

Models 46-200, 201, 202, 203, 420, 421, 250: If the oscillator is not stable at the low frequencies, change the oscillator grid-leak resistor from 47,000 to 120,000 ohms.

Model 46-480: If there is oscillation when the set is switched to FM, install a 240- μ f capacitor across C316, which can be found by tracing the wire from pin 3 of the 6H6 socket, through a 33,000-ohm resistor, to pin 1 on the band-

switch. From here C316 (.01 μ f) goes to ground.

To prevent oscillator drift on the same model when the push-buttons are used, replace C412 (485- μ f silvered mica capacitor) with a ceramic capacitor of the same value. Replace C413 (285 μ f) in the same manner. Both are across push-button oscillator coils.

To prevent drift and failure of the 7F8 in the 46-480, remove the 1-megohm resistor which goes from the 7F8 mixer cathode to B+. Change R300 (4,700 ohms, in the 7F8 plate circuit) to 47,000 ohms.

Model 46-120: If the set lacks pep, the second i.f. transformer may be bad due to heat from the tubes. Replace it with a Philco part No. AD-1024.

Model M8 Record Changer: If the changer keeps cycling, check the spring on the retractable segment of the cam

gear. If the spring is broken, replace the whole gear. If not, and if the segment is not binding, bend the little "ear" that stops the trip plate; it probably does not come over far enough to lock the segment. Be sure the little copper vane is at about a 40-degree angle when on trip.

Sets using 50A5 and 50X6: Replace the 50A5 if the tone is "mushy." If the 50A5 was shorted, replace the 50X6 as well. Check both voltage-doubling capacitors in the 50X6 circuit and all bypass and coupling capacitors.

1941 models using "beam-of-light" phonograph, 7B5 oscillator, and 7Y4 rectifier: Replace the 7B5 with a 7A5 and the 7Y4 with a 7Z4. This will make the beam light brighter and give more volume. Replace the two .01- μ f coupling capacitors in the circuit of the 41 output tubes, regardless of test results.

Fundamentals of Radio Servicing

Part IV—Capacitance

By JOHN T. FRYE

EVERY electrical circuit, whether it be a 1-inch length of wire or a cross-country telegraph line, has three "built-in" electrical properties: resistance, inductance, and capacitance. The first two of these we have already encountered in previous chapters; now we are ready to grapple with the third.

Capacitance is like discarded chewing gum; you may find it almost anywhere. Any time you have two electrical conductors separated by a nonconducting medium, you have a capacitor; and a capacitor is to capacitance what a doghouse is to a dog; it is where you normally expect to find it. By the light of this definition, you can see that your pocket watch and the furnace in the basement below form a capacitor; so does a clothesline and the antenna

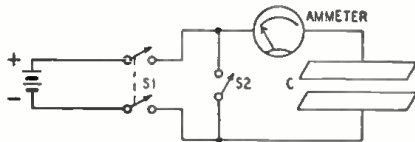

Fig. 1—Test setup shows capacitance effects.

stretched above it; so does a moisture-bearing cloud and the earth beneath.

In this free or "stray" state, capacitance is of little or no value; in fact it is often a nuisance. But when it is controlled and "lumped" in definite units, it is every bit as important to electricity as are resistance and inductance.

In its "cultured" state, capacitance comes in the packaged form of *condensers*, the common name for *capacitors*. There is a wide variety in the form and material used in such condensers; but before we start studying these practical units, let us see how a simple basic capacitor operates. Once we grasp how it works, we shall know how all capacitance units function.

Take a good look at Fig. 1. Here we have a capacitor C, consisting of two parallel flat metal plates with an air space between them. Switch S2 connects across these plates. The double-pole switch S1 permits us to connect the battery directly to the plates. An ammeter, an instrument for indicating

both the intensity and direction of any electrical current passing through it, is inserted in the lead going to the top plate of the capacitor.

To begin, let us say that S1 is open and that we have momentarily closed S2 and then reopened it.

Now, suppose we close switch S1. As we do so, the ammeter pointer flips over and then drops back to zero, indicating that a momentary current passed through it. Next, let us open S1 so as to disconnect the battery. What happens? Nothing; the ammeter pointer does not budge. But, suppose we now close S2. As we do so, the ammeter needle flicks again, but in the opposite direction, indicating a reverse flow of current.

Paradox or sense?

Several questions should be pulsing through your head at this point: Why did current flow in this circuit when we connected the battery? There was no complete circuit, for the plates of the condenser were separated by insulating air. After the current started flowing, why did it stop? Where did the current come from that caused the meter to flick when we closed S2? It could not come from the battery, for that had already been disconnected.

The explanations, as usual, go back to electron theory. The momentary closing of switch S2 before we connected the battery allowed any excess of electrons on either capacitor plate to flow through the switch and balance the electron distribution. At the instant the battery was connected, however, the positive terminal put a strong "come hither" on the negative electrons of the top plate, and they surged through the wire and the ammeter to that terminal, causing the ammeter to register their passage as they did so. At the same instant, the pent-up excess of electrons on the negative terminal of the battery rushed out on to the bottom plate of the condenser like school kids spilling out on the playground at recess. The result of this simultaneous "push-pull" action was to leave the top plate with a deficiency of electrons, giving it a strong positive charge, while the lower plate was strictly "Standing Room Only" with electrons and so had a negative charge.

As more and more electrons left the top plate and crowded on the lower plate, the charges on the two plates increased in opposite directions until the difference between them was exactly equal to the difference in potential between the two terminals of the battery. At this point, the electrons stopped flowing, because the pushing and pulling force of the charged plates exactly balanced the equal and opposing forces of the battery terminals.

Nothing happened when we opened S1, for there was no path by which the excess of electrons on the lower plate could reach the electron-hungry upper plate. Since this state of unbalance still existed, a voltage equal to that of the battery still was present between the plates, even though the battery itself had been disconnected.

The instant we closed S2 we provided the needed connecting path, and the displaced electrons rushed through it and through the ammeter to the upper plate. Since this time the electrons were flowing to the upper plate instead of away from it—as they were when the battery was first connected—the ammeter pointer moved in the opposite direction. As soon as the electrons were once more evenly divided between the two plates, they ceased to flow; and we were right back to the point we were before we started charging and discharging the capacitor.

We might have made one other experiment: When we had the battery connected to the capacitor (S1 closed), if we had slid a sheet of glass between

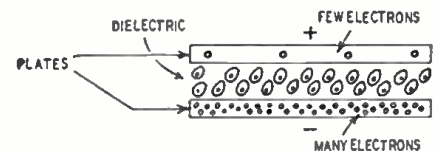

Fig. 2—Capacitor plates after being charged.

the plates, we should have noticed that the ammeter pointer flicked again, indicating that more charge was moving into the capacitor. When we removed the glass, the pointer would have moved in the opposite direction, showing that this new additional charge had moved

back out of the capacitor. An explanation of why the material used as the insulating medium of a capacitor (it is called the capacitor dielectric) affects the charge the capacitor will take will be given a little later.

It is apparent that a capacitor is a device for storing an electrical charge. The measure of its ability to do this storing is its *capacitance*. The amount of the charge stored depends upon how many electrons we can force to leave the top plate and congregate on the bottom plate. We know that the more voltage we have in our charging battery, the more power we have to do this forcing; so it should not come as a surprise that the unit used to measure the capacitance depends both on the number of electrons stored and the voltage necessary to do the storing. This unit is called the *farad*. One farad is the capacitance of a capacitor in which a coulomb (6.28×10^{18} electrons) of electricity is stored when an e.m.f. of 1 volt is applied. This unit is too large for practical use; so the *microfarad* (μf), a millionth part of a farad, and the *micromicrofarad* ($\mu\mu\text{f}$), a millionth part of a microfarad, are always used in radio.

The "why" of capacitance

We have explained *what* happens when a condenser is charged, but we have not explained *why*. Truth to tell, the pundits of electronics tend to take refuge in such phrases as "it is believed," "the theory is held," and "we may assume" when they go to talking about this subject; but here is what is generally thought:

A charged capacitor looks like Fig. 2, in which the ellipses between the plates represent, in a greatly exaggerated form, the out-of-round orbits of the electrons of the dielectric atoms in their paths about their respective positive nuclei. The orbits are out-of-round because of the attraction of the positively charged upper plate and the repulsion of the negatively charged lower plate. Were the electrons of the dielectric free to move, they would go straight to the positive plate; but since they are tightly bound, the best they can do is deviate slightly from their normal circular path.

When these orbits are comparatively easy to push out-of-round, their counter-repelling action on the electrons trying to muscle their way on to the negative plate will be comparatively weak, just as a weak spring puts up a feeble resistance to being compressed; consequently a large number of electrons can force their way onto the plate. The capacitance of the capacitor will be larger than it would be with a dielectric material in which the electron orbits were harder to distort. In the latter case, since the dielectric electrons would stubbornly refuse to budge from their orbits, the electrons trying to wedge their way on to the negative plate by distorting these orbits would be rebuffed, and the storage ability would be lessened.

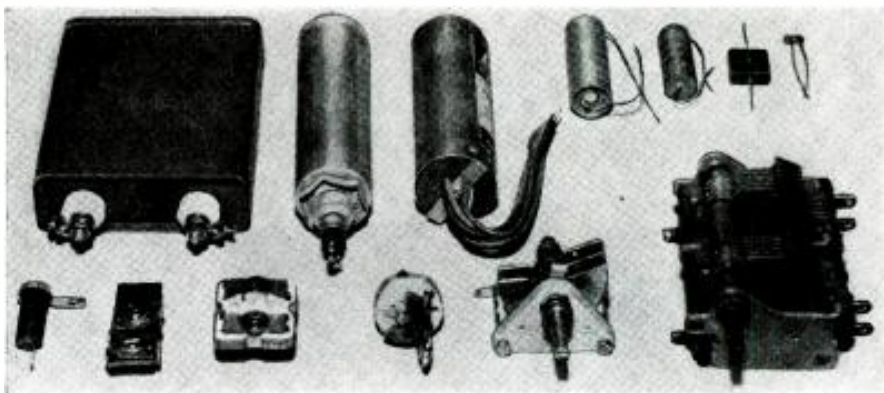

These capacitors illustrate the many types the technician will encounter in his servicing.

We could increase the capacitance by using a thinner slice of dielectric material, allowing the plates to come closer together. This would reduce the total number of the repelling dielectric electrons and so permit more electrons to collect on the negative plate of the condenser.

It is evident, then, that we can increase capacitance in three different ways:

(1) We can increase the size of the active portion of the plates. The active portions of the plates are the portions that are directly opposite each other and with the dielectric material squarely between them. Increasing the size of these portions means that we have more electrons to draw from the positive plate and more room on the negative plate to store them. When you remember that the resistance of the electrons of the dielectric material is "softened up" by the *double* action of the lower and upper plates, working as a combined pushing and pulling team, you can see why only the portions of the plates considered active have much effect on the capacitance.

(2) We can reduce the thickness of the dielectric material as discussed above.

(3) We can use a dielectric material whose electron orbits are more easily distorted.

The effect that the dielectric has on the capacitance is called the *dielectric constant* of the material and is expressed by the symbol *K*. Air is assigned a *K* of 1, and all other materials are compared with this. For example, replacing the air dielectric of a given capacitor with mica will multiply its capacitance about 5 to 7 times; so we say that mica has a *K* or dielectric constant, of 5-7. In the same way glass has a *K* of 4.5-7, and some rutile ceramics have a *K* of 90-170. No wonder the little cusses can pack so much capacitance in so small a space!

An ideal capacitor would be one with insulation so perfect that absolutely no current could leak across from one plate to the other; but ideal capacitors are like ideal picnics—they are never quite realized. We have *no* perfect insulators, and there is always *some* leakage. A capacitor with high leakage current is said to have a *high power factor*; just

remember that in capacitors power factors are like living costs—the lower, the better.

If we keep increasing the voltage across the plates of a capacitor, we eventually reach a point where the current will break through the dielectric and destroy it (unless, of course, it is air). Increasing the thickness of the dielectric will make this breakdown voltage higher, but it will also reduce the capacitance. Most capacitors used in radio work carry, in addition to their capacitance value, a marking indicating the maximum voltage with which they are to be used. These voltage ratings may vary all the way from a half-dozen volts to several thousand for various applications.

The picture shows the wide variety of capacitors used in radio work. In the next chapter we will take up the actual construction of capacitors, the good and bad points of each type. We will also find out why it is necessary to have so many different forms of capacitors when they all operate on the same basic principle.

If you are impatient to get to this discussion of the practical aspects of capacitor construction, just remember that unless you have a good, firm grasp of the theory of operation, you will have a hard time understanding *any* type of construction, whether it be an internal combustion engine or a baby's three-cornered pants!

AUTOTRANSFORMER

While converting a 110-volt a.c.-d.c. radio to operate on 220 volts a.c., I was unable to get a suitable step-up transformer or line-cord resistor. I took an old power transformer with a burned out primary and connected the 220-volt line across the ends of the high-voltage secondary. The radio was connected between the center tap and one side of the winding. I have used this method with good results for some time.

D. E. O'N. WADDINGTON.
Natal, South Africa.

(When selecting a transformer for such service, be sure to select one with a secondary capable of carrying comparatively heavy current. The same setup can be used for operating 220-volt equipment from 117-volt a.c. lines, that is, for stepping voltage up.—Editor)

Television and FM Alignment



McMurdo Silver Model 911 generator.

How to align television and FM receivers, using a modern sweep generator and scope

By
DOUGLAS H. CARPENTER*

THE modern television receiver imposes many new service problems that have no counterparts in the more familiar AM practice. Aligning TV sets requires specialized apparatus with which the average service technician has had little experience.

Television, without a doubt, will be the major broadcasting field within a very few years; the wise technician is the one who is now preparing to be a part of this lucrative industry. There are only three things that he must possess: a thorough knowledge of TV receivers, modern service equipment, and a knowledge of how to use this equipment intelligently.

Reference to the schematic (Fig. 1) indicates the essential circuits of a TV alignment instrument. Two 12AT7 twin-triodes are used as reactance modulator, fixed-frequency oscillator, variable-frequency oscillator, and mixer. The reactance modulator causes the frequency of the "fixed" oscillator to shift around its center frequency when a modulating voltage is applied to the reactance modulator grid. The linear variation of the fixed oscillator (the amount that the carrier may be shifted in either direction) is controlled by the setting of P1, the sweep-control potentiometer. We have, therefore, a fixed oscillator whose frequency may be swept or frequency-modulated some 10 mc at the maximum setting of P1. The amount of carrier swing is shown directly on a scale.

The output of the fixed oscillator is taken from across the cathode resistor R2 and fed to the grid of the mixer tube through the coupling capacitor C8. The output of the variable-frequency oscillator is also fed to this mixer grid through the 10- μ f capacitor. The mixer tube operates as a cathode follower, its cathode load being the output control P2. Both the sum and difference frequencies generated by the mixing of the

two oscillators are available across P2.

The frequency of the fixed oscillator in the McMurdo Silver Model 909 and 911 sweep generators is set at 114 mc. The variable-frequency oscillator in both instances covers the range of 37 to 112 mc. For this discussion the Model 909 may be considered similar to the 911, with the exceptions that the 911 contains the crystal marker circuit (a 12AU7), and the phasing control (P3), shown in Fig. 1.

The frequency range produced by the mixing of the variable and fixed oscillators is a continuous 2 to 226 mc, directly calibrated in three scales on the main vernier tuning dial. The first range of 2 to 77 mc is produced by the difference between the two oscillator

frequencies. The second or middle scale, calibrated 60 to 154 mc, is the second harmonic of this difference frequency. The sweep width in this instance is double that obtained on the 2-77-mc range. The outer scale, calibrated from 151 to 226 mc, represents the sum frequency generated by the mixing.

When two high-frequency oscillators are mixed to produce a low-frequency output, it is extremely difficult to keep the lower frequency accurate. Drift in either oscillator which is only a small percentage of its fundamental frequency may show up as a large error when translated to the low-frequency mixed output. It is for this reason that manufacturers advocate the use of marker signals accurately to trace out pattern

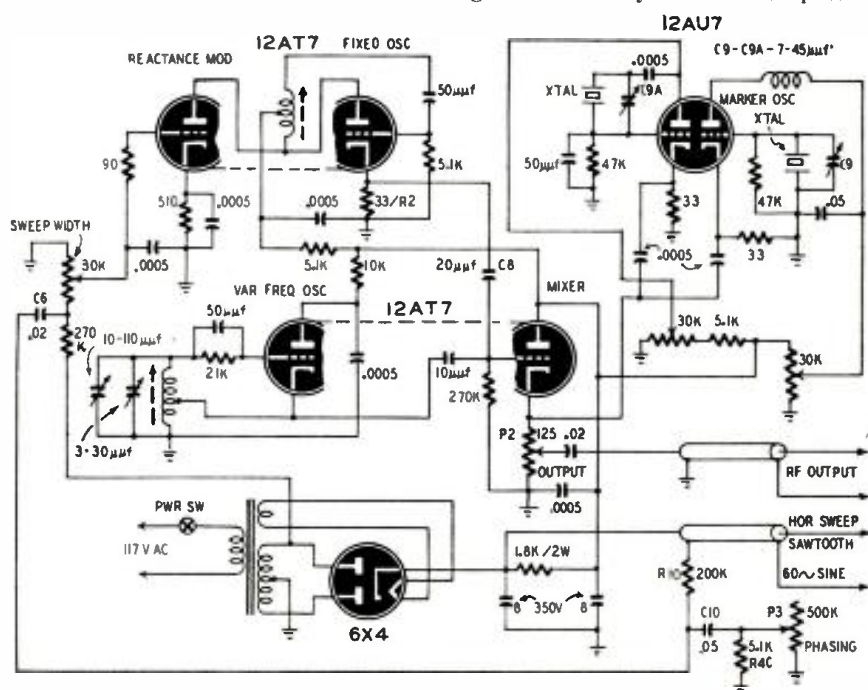

Fig. 1—Schematic of the 911. The instrument includes marker oscillator and sync outputs.

*Chief Engineer, McMurdo Silver Co.

response and to determine TV frequency and bandwidth. Some manufacturers have gone so far as to use dials that cannot be read closely enough for alignment work, thus forcing the technician to use a separate marker system. The only method of avoiding the use of a separate marker is to recheck dial calibration against known sources and compile a chart of the most-used points. Although such a system may be used with relatively narrow passbands such as with FM, i.f. and discriminator patterns, it is definitely not applicable to video i.f. work. For this reason the marker system and phasing control have been incorporated in Model 911. Both Models 909 and 911 may be used for either FM or TV alignment, but the 909 requires a separate external marker system to determine the exact frequency and bandwidth of TV patterns. This marker may be any test oscillator of the correct frequency and necessary accuracy. The Model 911 is an "all-in-one" instrument incorporating a dual crystal-marker system as well as a phasing control used to produce a single image when inspecting asymmetrical passbands such as video i.f. responses.

FM and TV receivers may be aligned rapidly with either instrument. The important points with an FM receiver are the i.f. and discriminator patterns. The table has been prepared as a quick reference guide. It assumes that phasing control is used in television alignment. The phasing control circuit incorporated in Model 911 can be copied, and built externally or into the 909, as the technician prefers. The phasing network consists of C6, C10, R10, R4c, and P3. The only connection that has to be changed in the 909 is the shield braid of the horizontal synchronizing cable. In manufacture this was connected internally to ground. It must be disconnected and utilized as the means of obtaining the 60-cycle phased voltage through C6. It serves as the output line for this voltage, and a phone tip may be connected to the output end of the cable braid to allow convenient connection to the 'scope binding post. The phasing network may be built in a few minutes, and all components are common in any radio shop.

It will be noted in Fig. 1 that two separate types of 'scope-control voltages are available from Model 911. These two voltages are provided to accomplish direct control of the beam through the horizontal amplifier for two different conditions. When the sweep generator is used to inspect a symmetrical passband, the output connection labeled SAWTOOTH is connected to the high side of the horizontal amplifier. No separate ground connection need be provided for the control voltages in any case, as a ground is made automatically when the 'scope's vertical amplifier input is connected to the receiver. Symmetrical passbands include FM-receiver i.f. and discriminator responses, and sound channels of television sets. The control voltage provided in this case is a 120-cycle sawtooth that is in phase with the

reactance-modulator sweep voltage. Since the fixed oscillator is swept with a 60-cycle sine wave, the sweep rate is twice this, or 120 sweeps per second. If the coarse frequency control of the 'scope is turned to OFF and the 120-cycle sawtooth voltage is used for direct control through the horizontal amplifier, mirror-image responses will be observed.

This means that two response curves will be seen, one the actual response, the other the same curve backward. To illustrate this, assume a very distinct asymmetrical i.f. response as shown in Fig. 2-a. (This is never obtained in practice but it makes a good illustration because the upper- and lower-frequency slopes are obviously different.)

The sawtooth voltage sweeps the cathode beam to the right in $\frac{1}{120}$ second. The first half-cycle of the 60-cycle-modulated generator output passes through the i.f. amplifier under test in $\frac{1}{120}$ second. Therefore, on the first half of the modulator cycle, the actual amplifier response curve is shown on the oscilloscope screen.

Now, in the second half-cycle of modulation, the generator output is swept over the same frequency range, but from high to low frequency—backward. The 120-cycle sawtooth, however, again traverses the screen in the same direction as before, toward the right. The beam spot is being pushed to the right, but its vertical deflection is governed by the amplifier response curve in reverse because the modulator is making the frequency decrease rather than increase as it did on the first half-cycle. The result is that the reversed picture of the amplifier response will appear on the screen. It will be exactly where the actual response appeared during the first half-cycle if the center of the response is at the center frequency of the FM generator. Since the two are being traced at a comparatively high rate of speed, the eye sees both the actual and reversed curves simultaneously. The two are superimposed, reversed—or mirror—images of each other as the drawing (Fig. 2-b) clearly indicates.

(Continued on following page)

ALIGNMENT TABLE

Alignment	Generator connections	Oscilloscope connections	Oscilloscope control voltage	Notes	Response
FM discriminator (ratio-detector type)	converter grid	junction of discriminator-transformer tertiary winding and de-emphasis network	120-cycle sawtooth	substitute 1 1/2-volt flashlight cell for 3-8-μf stabilizing capacitor; receiver oscillator shorted	Fig. 4
FM oscillator	antenna post	as for i.f. alignment	"		Fig. 3
FM r.f.	"	"	"	adjust for maximum amplitude	Fig. 3
FM i.f. (limiter-discriminator type)	each i.f. grid in turn	across first-limiter grid resistor	120-cycle sawtooth	short receiver oscillator	Fig. 3
FM discriminator	converter grid	ungrounded discriminator cathode	"	"	Fig. 4
FM i.f. (ratio-detector type)	each i.f. grid in turn	junction of discriminator-transformer tertiary winding and de-emphasis network	"	disconnect 3-8μf stabilizing capacitor; receiver oscillator shorted	Fig. 3
TV video i.f.	each i.f. grid in turn	across video second-detector load resistor	60-cycle sine	adjust phasing control for single image; employ markers to establish correct bandwidth	Fig. 5
TV oscillators	antenna posts	not used	not used	set generator to center of sound channels; adjust trimmers for loudest 120-cycle sweep tone at speaker	
TV r.f.	antenna posts	across second-detector load	60-cycle sine	see text	Fig. 6

Suppose now that the amplifier being tested is an FM i.f. Ideally, the curve should be symmetrical—the slope on both high- and low-frequency ends should be the same. As the correct adjustments are made in the set to achieve symmetry, the actual and image slopes on one side will tend to approach each other, the more slanting one becoming steeper and the more vertical one becoming more gradual. The same will occur on the other side. When the upper- and lower-frequency slopes are exactly equal, and the center frequency of the passband is the same as the center frequency of the generator, the actual and mirror-image curves will coincide and only one curve will be seen.

This type of response is desired in the alignment of FM receivers. If the output cable labeled 60-CYCLE SINE is used for direct control through the horizontal amplifier, one image will be observed when the phasing control is properly adjusted. It is of little value to obtain one image of a symmetrical passband because the advantage of visual comparison of opposite sides is lost. It would also be confusing to have a mirror-image response of an asymmetrical pass band (such as a video i.f.) because opposite sides of the pattern should have different slopes and trap responses. For this reason two distinct types of control voltages are made available to satisfy the two entirely different conditions. When using Models 909 and 911, the time base of the 'scope is turned off, and no additional 'scope adjustments are necessary.

Alignment procedures

Here is a typical alignment procedure using the 911. Reference to the table will simplify the explanations.

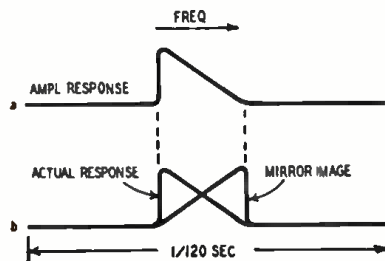

Fig. 2—An example explains the mirror image.

To align an FM receiver it is first necessary to short out the receiver oscillator. The sweep-generator output clips are connected from the last i.f. grid to ground. The 'scope coarse frequency control is turned to OFF. The 120-CYCLE SAWTOOTH cable is connected to the high side of the 'scope's horizontal amplifier. Connect the vertical amplifier across the first limiter grid resistor. When appropriate sweep is applied, the mirror-image response of Fig. 3 will be obtained. The last i.f. trimmers are adjusted so that the two patterns coincide. This procedure is repeated, connecting the generator in turn to each preceding i.f. grid and finally to the converter grid.

Without changing the dial setting of

the sweep generator, connect the 'scope vertical amplifier to the ungrounded discriminator cathode. Adjust the discriminator trimmers until a symmetrical pattern like that of Fig. 4 is obtained. If the FM receiver employs a ratio detector, simply follow the in-

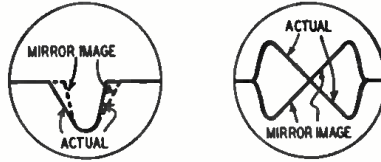

Fig. 3 (left) and Fig. 4 (right)—FM receiver i.f. and discriminator oscilloscope patterns.

structions given in the table for this case.

The next step is to adjust the oscillator and r.f. sections. The receiver oscillator is restored and the generator connected to the antenna binding posts. The 'scope's vertical amplifier is again connected across the first-limiter grid resistor (in the case of ratio-detector receivers follow the table). The generator dial is set to the appropriate r.f. alignment frequency, and the oscillator trimmer adjusted to give the superimposed i.f. patterns. The r.f. trimmers are next adjusted for maximum amplitude.

The problems encountered in video i.f. alignment are entirely different. Here we are dealing with a passband some 4 mc wide as well as with adjacent trap circuits which must be set up properly. Reference to Fig. 5 reveals that this pattern is not symmetrical. For these reasons it is desirable to observe only one image on the 'scope screen. The output cable labeled 60-CYCLE SINE is connected to the high side of the 'scope's horizontal amplifier. The vertical amplifier is connected across the video second-detector load resistor. The generator output clips are connected from the last video i.f. grid to ground. The phasing control is adjusted to obtain a single image. If this control is not adjusted properly, a double image will be observed, resembling somewhat the mirror-image effect described before.

The output of the generator is progressively moved, stage by stage, from the last i.f. grid through to the converter. Exact responses specified by the manufacturer must be duplicated in each stage. For stagger-tuned systems this cannot be overemphasized. A variation in the pattern response of any single stage could result in a loss of picture contrast and quality.

The 5-mc crystal marker is next turned on. The variable amplitude control of this oscillator (30k in the schematic of Fig. 1) is adjusted to give a convenient-sized pip on the pattern. This pip is a harmonic of the 5-mc oscillator, and in the case of a standard i.f. will lie at 25 mc. If the pip appears at the proper point in the over-all response, the initial alignment procedure may be considered correct.

The next step is to adjust the trap

circuits. The 5-mc oscillator is turned off and the 1-mc oscillator employed. A series of pips 1 mc apart will be observed across the i.f. response. One of these will lie at the same spot as the 5-mc pip previously observed. It is then a simple matter to count down or up from this reference pip to determine exact bandwidth and frequency.

The trap circuits are next adjusted in relation to the 1-mc pips. The two marker oscillators should not be used simultaneously, nor need they be. Unless the two oscillator harmonics are exactly equal, an audio voltage is created by the difference. The audio voltage will show up on the pattern unless a filter is employed between the generator and the 'scope. This is not harmful in any way. The oscillators may be brought to zero beat by adjustment of C9 and C9a. The oscillators can be referred to WWV at 5 mc.

All that has been done with these crystal oscillators may be accomplished by the serviceman's own test oscillator, if it can be calibrated accurately, and Model 909.

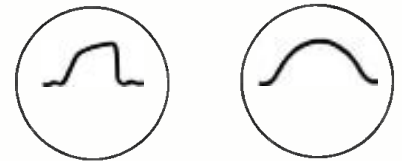

Fig. 5 (left) and Fig. 6 (right)—Video i.f. and television r.f. patterns on 'scope screen.

The next job is to set the oscillator and r.f. sections for all channels. The oscillator is restored to operation and the generator connected to the antenna posts. The receiver is set to the highest channel, and the fine frequency control adjusted half way. The generator is set to the center of the *sound channel* and the oscillator adjusted until the 120-cycle sweep signal is heard in the receiver loudspeaker. All channels are set in this manner, working from the highest to the lowest frequency.

R.f. sections usually require little or no adjustment. Most modern TV receivers employ preset coils, and do not rely on capacitive or inductive compensation. The turns are set at the factory; and if the set is functioning satisfactorily, it is better not to attempt adjustment.

If the set employs capacitive or inductive (slug) compensation, connect the generator to the antenna posts. Connect the 'scope vertical amplifier across the second-detector load, and the 60-cycle control voltage to the high side of the horizontal amplifier. Again one image of the video i.f. response will be observed when the generator is set to the appropriate r.f. channel. The compensating trimmer for the r.f. coil is now adjusted carefully for a slight increase in the height of the image. Start at the highest channel and work down.

The table can be used as an alignment reference when using either the instruments described or similar apparatus.

MICROWAVES

Part II—An introduction to standing waves, cavity resonators, and representative examples of u.h.f. plumbing

By C. W. PALMER



Photos courtesy DeMornay-Budd



For extracting samples of energy traveling in either direction along a waveguide, directional couplers are needed.

In Part I of this series we considered a number of the practical factors governing the use of waveguides for ultra-high-frequency transmission and reception.

The use of parallel-wire and co-axial transmission lines becomes impractical above approximately 3,000 mc because of the greatly increased losses as frequency rises. For example, RG/8U co-axial cable, which has a loss of 0.13 db per 100 feet at 1 mc and 2.1 db at 100 mc, has a loss of 18 db at 3,000 mc; and RG/58U cable, which has a loss of 0.24 db per 100 feet at 1 mc, has losses of 4.1 db at 100 mc and 34 db at 3,000 mc. A glance at Fig. 1 shows how loss increases with frequency for these two popular cables.

This explains why such a wide interest has been displayed by u.h.f. investigators in the development of waveguides. The loss in 1 x 1/2-inch waveguide for frequencies from 6,500 to 12,500 mc was shown in Part I of this series. It drops from 80 db per 100 feet at 6,500 mc to 30 db at 12,500 mc. Similar values of attenuation are found for other sizes of waveguide for their optimum frequency ranges. Also, the waveguide will carry much higher power than co-axial conductor without arcing over.

A waveguide can be used at any frequency above its cutoff point, but a certain band of frequencies is transmitted with the least loss. This is due to the "skin" resistance on the inside of the waveguide, which increases with frequency. Since the penetration of radio-frequency currents into the surface of

a conductor (in this case the inside wall of a waveguide) is inversely proportional to the frequency, it follows that at frequencies above some critical point there will be an increase in loss. Table I shows the skin penetration and resistance of some commonly used waveguide electroplating and fabricating metals—the five most commonly used in waveguide construction.

Standing waves

Standing-wave ratio is a term often heard where transmission lines as well as waveguides are concerned. If a length of waveguide is provided with movable ends so that it becomes a closed container, it will resonate at a

particular frequency just like a tuned circuit consisting of a coil and capacitor. This is because the voltages are reflected by the end plates and reinforce the applied voltage at one and only one frequency. At this frequency the reflected voltages combine with the applied voltage and thus increase the original voltage at one point in the cavity (where we place the pickup dipole or loop).

This subject of standing waves in transmission lines and waveguides is so important in the practical application of microwave plumbing that it is well for us to spend some time on the subject.

Let us look at Fig. 2 which shows a rope secured to a stationary hook and

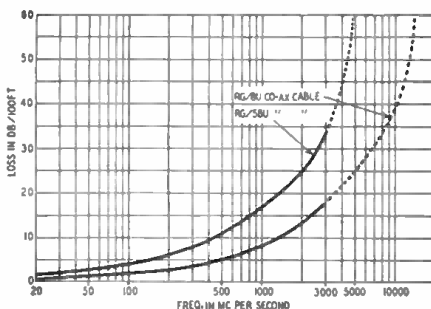

Fig. 1—Graph shows losses in co-axial cable.

TABLE I
R. F. RESISTANCE AND SKIN PENETRATION

Depth of current penetration is given in millionths of a meter (.001 mm).

Metal	100 mc		1000 mc		10,000 mc	
	Ohms	Depth	Ohms	Depth	Ohms	Depth
Silver	.0025	6.5	.008	2.0	.025	.65
Copper	.0026	6.6	.0083	2.1	.026	.66
Gold	.0032	8.2	.0103	2.6	.032	.82
Aluminum	.0034	8.6	.011	2.7	.034	.86
Brass	.005	12.6	.016	4.0	.05	1.26

swung back and forth to provide a wave motion. If the rope is held at the correct tension and swung back and forth rhythmically (simulating waves of oscillating or alternating voltage), modes will be formed as shown by the cross-over of the solid and dotted lines where the rope remains stationary while other parts of the rope move back and

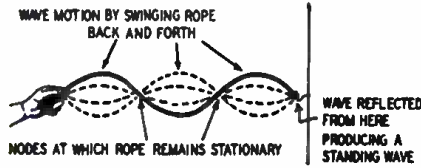

Fig. 2—Swinging rope forms loops and nodes.

forth. This is caused by the wave reflected by the stationary end of the rope producing a standing wave in the motion of the rope.

Now if we have a transmission line of two infinitely long parallel wires connected at one end to a source of r.f. power, as shown in Fig. 3-a, the r.f.

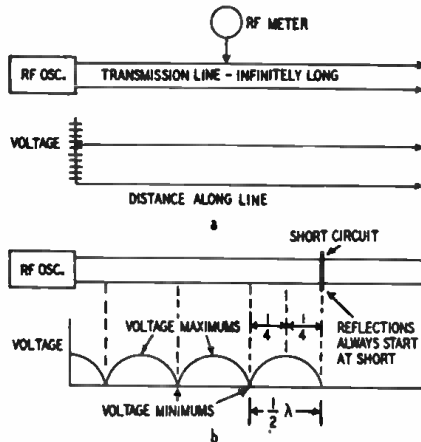

Fig.—3 Standing waves form on shorted line.

voltage will travel along the line with no reflections and there will be no standing waves; but if we provide a short circuit across the line at some point as at b, reflections will occur, with resulting standing waves, voltage maxima and minima along the line at intervals.

If a resistance connected across the transmission line matches the characteristic impedance of the line (depending on the space between the wires and their size), the outgoing signal from the source is completely absorbed by the load and there are no reflections or standing waves. This is usually desirable in connecting a signal source to a load (as in connecting a transmitter to an antenna) since the maximum amount of power is delivered by the source to the load.

When the load is resistive and matched to the impedance of the line, the voltage is essentially the same all along the line; the length of the line is not critical. The impedance is uniform along the line and is equal to its characteristic impedance. The standing-wave ratio is extremely low and there is, therefore, a maximum transfer of energy.

If the load is not matched to the line or is reactive instead of resistive, the signal is reflected back from the load. The standing-wave ratio is high, and the voltage varies greatly from one half-wave position to the next. The length of the line is critical, and there is a loss of power.

All these characteristics of transmission lines with respect to standing waves also apply to waveguides, though the method of determining the standing-wave ratio and correcting for a mismatch or high standing-wave ratio is different.

In waveguides, standing-wave ratio is checked by means of a special section of guide having a narrow slot cut parallel to the axis of the guide (located at the maximum of the electrostatic field). A probe with a crystal detector and a d.c. microammeter is used to indicate the presence of standing waves. The photograph shows a slotted waveguide section that can be used to measure standing-wave ratio, impedance, and frequency.

Cavity resonators

In waveguides all the old circuit quantities, such as inductance, capacitance, resistance, reactance, etc., have their place and usefulness, though their forms are different from those found in lower-frequency work.

A piece of waveguide of the correct length, with the ends closed off, can be used just as are the more common coil and capacitor for a tank or resonant circuit, displaying all the characteristics of a coil-and-capacitor combination without actually containing either coil or capacitor.

The resonant cavity can perhaps be better understood by looking at the sketches in Fig. 4. At a is the usual coil-and-capacitor parallel-resonant circuit. As the frequency is increased, the number of turns on the coil is decreased until eventually only a single turn is required. This is shown at b. Now to reduce the inductance further, several

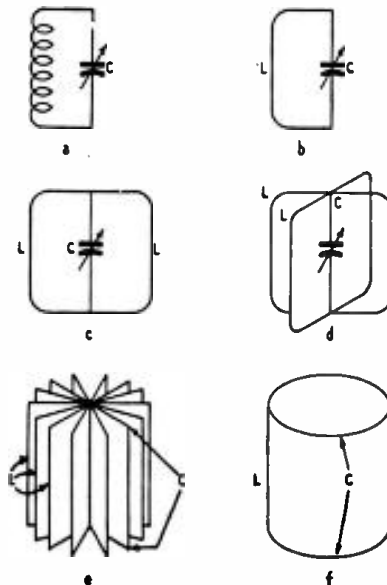

Fig. 4—The evolution of a cavity resonator.

coils are connected in parallel as at c and d. It will be remembered that the inductance of two coils in parallel is less than either coil individually. By adding an infinite number of single-turn coils in parallel, a closed chamber or resonant cavity results as shown in e and f.

Strictly speaking, we should not use the term inductance in a resonant cavity, as the resonance is a result of reflection of radiated waves in such phase as to reinforce their potential. However, this approach does make it easier to understand how a cavity can be tuned to a given frequency.

A rectangular cavity can be resonated at several frequencies by changing the mode. You will remember that we explained the electrostatic and magnetic modes of transfer of energy in waveguides and that, for each mode, one dimension of the guide controls the lowest or cutoff frequency. The choice of mode was made by the type and location of the insertion and pickup probes. The same conditions occur in cavity resonators as in waveguides, in this respect.

In Fig. 5 dimension a, b, or c may be made to control the resonant frequency by changing the position or type (dipole or loop) of the coupling and pickup devices. For any one mode, two side walls control the frequency, and the other walls control the Q or merit factor of the resonator.

In tuned circuits of the coil-and-capacitor variety used at lower frequencies, Q figures up to several hundred are typical. For cavity resonators, Q factors in the tens of thousands are not uncommon. In this respect the cavity

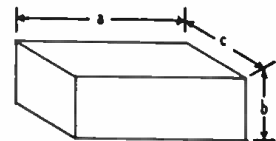

Fig. 5—The critical dimensions of a cavity.

resonator is different from and much more efficient than a low-frequency tuner.

Types of resonators

Cavity resonators take a number of different shapes and forms other than the simple rectangle shown in Fig. 5. For example, some vacuum tubes used for microwaves—notably reflex Klystrons—include a resonant cavity as part of their build-up. The grids form one boundary of the cavity, and the cylindrical bellows is another of the elements from which the output is taken. Figure 6 shows the cross sections of a number of different types of cavity resonators, including the basic principles of the reflex Klystron and Magnetron tubes to be discussed in detail in the next article of this series.

The size and shape of the cavity determine the frequency of oscillation. If the cavity is too small or too large, it cannot resonate at a given frequency; but if it has the correct dimensions, high-amplitude waves are built up be-

it's ALLIED for hallicrafters!

hallicrafters
Model T-64
Television Chassis
with exclusive
"DUAL-FOCUS"
feature

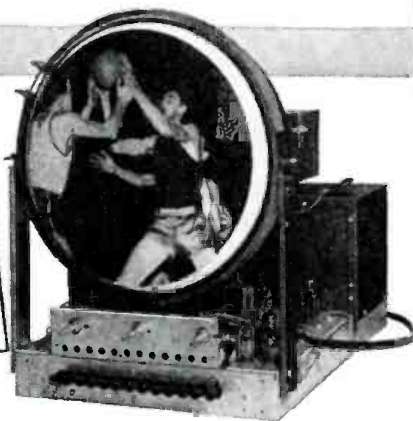

Tops for custom installations at low cost—a factory-built direct-view chassis for 10 or 12-inch tubes. With exclusive new Dual-Focus switch—10" tube gives you choice of big 64 sq. in. telescopic view for dramatic closeups, or large 56 sq. in. full-range view. Either way, you get a sharp picture, with fine stability and superb contrast. Features: 12 channel push-button tuning; RF amplifier; 3 IF amplifiers; 2 video amplifiers; improved sync circuits; AGC; static-free FM audio system. Complete with power supply, speaker and 15 tubes, plus 3 rectifiers. Less picture tube (you can use either 10" or 12" size). For 105-125 volts, 50-60 cycles AC. Shpg. wt., 60 lbs.

- 97-875. Hallicrafters T-64 Television Chassis. Only... \$169.95
\$33.99 down, \$12.01 monthly for 12 months.
- 6-780. 10BP4 10" picture tube. Shpg. wt., 20 lbs. NET. \$34.00
- 7-211. 12LP4 12" picture tube. Shpg. wt., 25 lbs. NET. \$60.00
- 97-885. Bracket to permit use of 12" tube with chassis. NET. \$8.50



hallicrafters S-40A and S-52 All-Wave Receivers

Popularly-priced Hallicrafters communications receivers, packed with advanced features. Cover 550 kc to 43 mc in 4 bands. Highlights include: full electrical bandspread; inertia flywheel tuning; calibrated main dial; au-

tomatic noise limiter; adjustable pitch BFO; standby switch; code-phone switch; headphone jack; shock-mounted speakers; separate sensitivity and volume controls; 3-position tone control. All tubes included. In handsome all-steel cabinet, 18 1/2"x9"x11". Shpg. wt., 32 lbs.

- 97-546. S-40A, for 105-125 v., 50-60 cy. AC.
- 97-588. S-52, for 117 volts AC or DC.
- YOUR NET PRICE, EITHER MODEL, ONLY... \$99.50
\$19.90 down, \$7.03 monthly for 12 months

FREE

Send for
Your Copy
of the
180-Page

ALLIED Catalog

Radio's Leading Buying Guide

Get the Radio Buying Guide that's used by thousands of expert servicemen, engineers, amateurs, soundmen, builders and experimenters. Get every buying advantage at ALLIED: widest selection of equipment at money-saving low prices—speedy, expert shipment—personal attention—complete satisfaction on every order. Get your ALLIED Catalog today—use handy coupon below!



hallicrafters S-38 the Super-Value Receiver

The all-star, all-wave value that amazes even the experts. Covers 4 full wave bands, continuous range from 540 kc to 32 mc. Features: full electrical bandspread; Noise Limiter; Band Selector; BFO pitch; Voice-Code switch; Speaker-headphones switch; Standby-receive switch; latest PM speaker. In handsome furniture-steel cabinet; 12x7x8" Complete with all tubes. For 105-125 v., 25-60 cy. AC, or 105-125 v. DC. Shpg. wt., 15 lbs.

- 97-564. Model S-38 Receiver. Only... \$39.95

ALLIED STOCKS ALL HALLICRAFTERS MODELS

Hallicrafters SX-42 (less speaker)	\$275.00
Hallicrafters SX-62 (less speaker)	269.50
Hallicrafters SX-43 (less speaker)	189.50
Hallicrafters S-51 (complete)	149.50
Hallicrafters S-53 (complete)	89.50
Hallicrafters HT-17 Transmitter	39.50
Hallicrafters HT-18 Oscillator	110.00

All Prices Net F.O.B. Chicago

Radio's Leading
Buying Guide...

FREE



- ALLIED RADIO CORP., Dept. 2-E-9
833 W. Jackson Blvd., Chicago 7, Illinois
- Send FREE 180-page ALLIED Catalog
- Enter order for Hallicrafters Model.....
- Enclosed \$..... Full Payment
- Part Payment (Bal. C.O.D.)
- Send ALLIED Easy Payment details and order blank

Name.....
Address.....
City..... Zone..... State.....

Everything
in Radio
and Electronics

★ ALLIED
RADIO

tween the reflecting walls. As in waveguides, cavity resonators have different modes of resonance. One pair of opposing walls becomes the frequency-controlling mechanism, while the others affect the impedance and Q of the unit.

Cavity resonators may be tuned by moving the side walls in or out, or tuning slugs may be inserted, as shown in

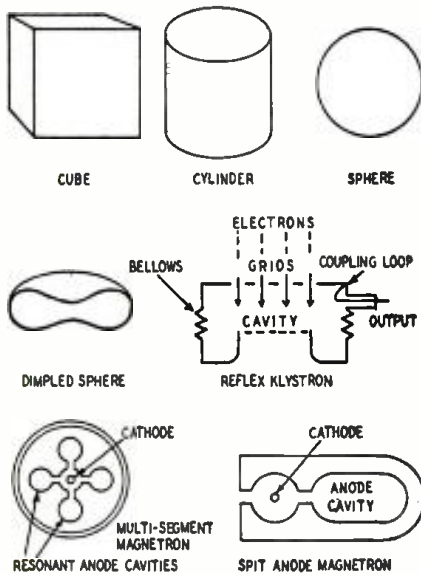

Fig. 6—Resonant cavities take various forms.

Fig. 7, to increase or decrease the frequency. The tuning slugs consist of metal rods that may be moved into or out of the cavity. If the slugs are located in the path of the electrostatic field (depending on the mode), the frequency decreases as the slugs are inserted. If they are inserted in the electromagnetic field, the frequency increases. This is because inserting the slugs in the electrostatic field shortens

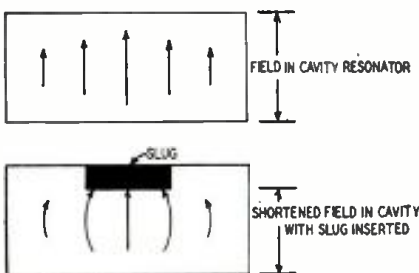

Fig. 7—This cavity may be tuned with a slug.

this field, which is similar to increasing the capacitance of a tuned circuit. Conversely, inserting the slugs in the electromagnetic field decreases that field,

which is the equivalent of lowering the inductance.

Samples of waveguide plumbing

We have touched on a number of the factors controlling the individual pieces of apparatus comprising a microwave waveguide setup, but so far we have not pieced them together to form a circuit. Let us look at Figs. 8 and 9. Here we have two setups used for testing purposes. They serve as examples of how the pieces of apparatus are linked together to propagate waves.

Figure 8 shows an oscillator, such as a Klystron or Magnetron, coupled to the following five pieces of apparatus in turn:

1. An impedance meter which consists of a length of waveguide with a longitudinal slot in one wall in which a rod or probe connected to a crystal detector and a d.c. microammeter can be moved.

2. An impedance transformer consisting of a length of waveguide with impedance-adjusting slugs or stubs which change the amount of power reflected back toward the source, thus introducing standing waves of controllable amounts to change the effective impedance.

3. A directional coupler which permits a small sample of the wave to be taken off through a side path without affecting the propagation of the main wave through the guide, except for introducing a certain amount of attenuation. This sample wave is fed through a waveguide or co-axial line to a frequency meter where its frequency can be determined by measuring the distance between the high-voltage or high-current points.

4. Another directional coupler feeding into a power meter or wattmeter permits the power transmitted through the waveguide to be measured. This power meter may be a bolometer or temperature-sensitive resistance element, a power bridge, a water load, or other power indicators (which we will take up in a succeeding article);

5. Last in the circuit is the termination or power-absorbing device, which is used to dissipate the power from the oscillator without radiating it and without introducing reflections that would affect the operation of the measuring devices by introducing a high standing-wave ratio in the line.

This circuit is used to measure the effect of a changing load impedance on the amount of useful power propagated through a waveguide, as, for instance, in changing the antenna of a microwave transmitter.

Fig. 9 shows another test setup for

measuring the amount of reflection introduced by a section of waveguide over a wide range of frequencies. Here a Klystron oscillator is amplitude-modulated by a square-wave oscillator and fed into the test circuit, which comprises:

1. A variable attenuator for controlling the power from the Klystron and isolating it from the test setup;
2. A tee section of waveguide coupled to a frequency meter;
3. An impedance meter with slotted wave guide;
4. The section of waveguide under test;
5. A power termination.

The impedance meter is used here to measure any reflection that occurs when the section of guide under test is inserted, over that measured when the termination is coupled directly to the impedance meter. This test is made at a series of frequencies.

In these two examples of waveguide plumbing a number of new items have been described in a rather sketchy manner in order to show the over-all result of applying apparatus to a circuit for a specific purpose. Each of these items will be taken up in turn and described in greater detail in succeeding parts of this series, so that we can build up a working knowledge of the devices and how to use them.

One of the greatest stumbling blocks in the path of microwave development for many years was the inability of ordinary vacuum tubes to either amplify or oscillate successfully at frequencies in the thousands-of-megacycles region. Several factors were responsible. Interelectrode capacitances negligible at more amenable frequencies became prohibitively high at microwaves; leads from the elements to the pins made highly effective—and damaging—inductances; insulation losses and grid emission made u.h.f. oscillation impossible. And perhaps most important, the time required for electrons to reach the plate from the cathode—transit time—became comparable to the period of a single cycle. As a result, the upper oscillation limit of ordinary tubes was between 150 and 175 mc.

How entirely new principles were conceived and developed to achieve amplification and oscillation at frequencies considered impossible of attainment a few years ago will be discussed in Part III of this series. For the technician and experimenter unfamiliar with microwaves, the descriptions of the Megatron, the orbital beam tube, the Klystron, and the Magnetron will open new and exciting fields for thought and experimentation.

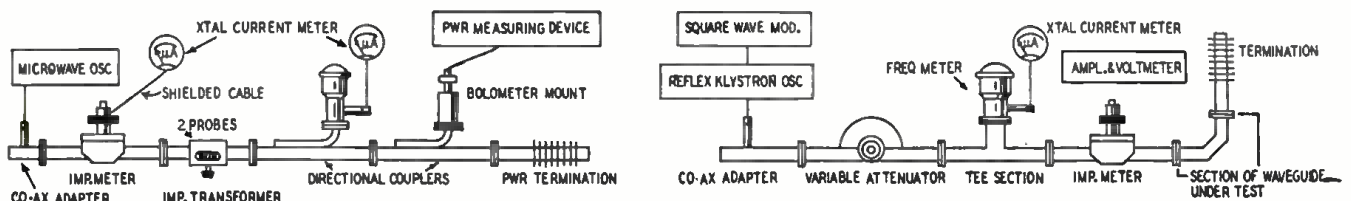

Fig. 8 (left) and Fig. 9 (right)—Two representative circuits using waveguide plumbing illustrate how various components may be combined.

SAVE TIME!



SAVE MONEY!



SAVE SPACE!

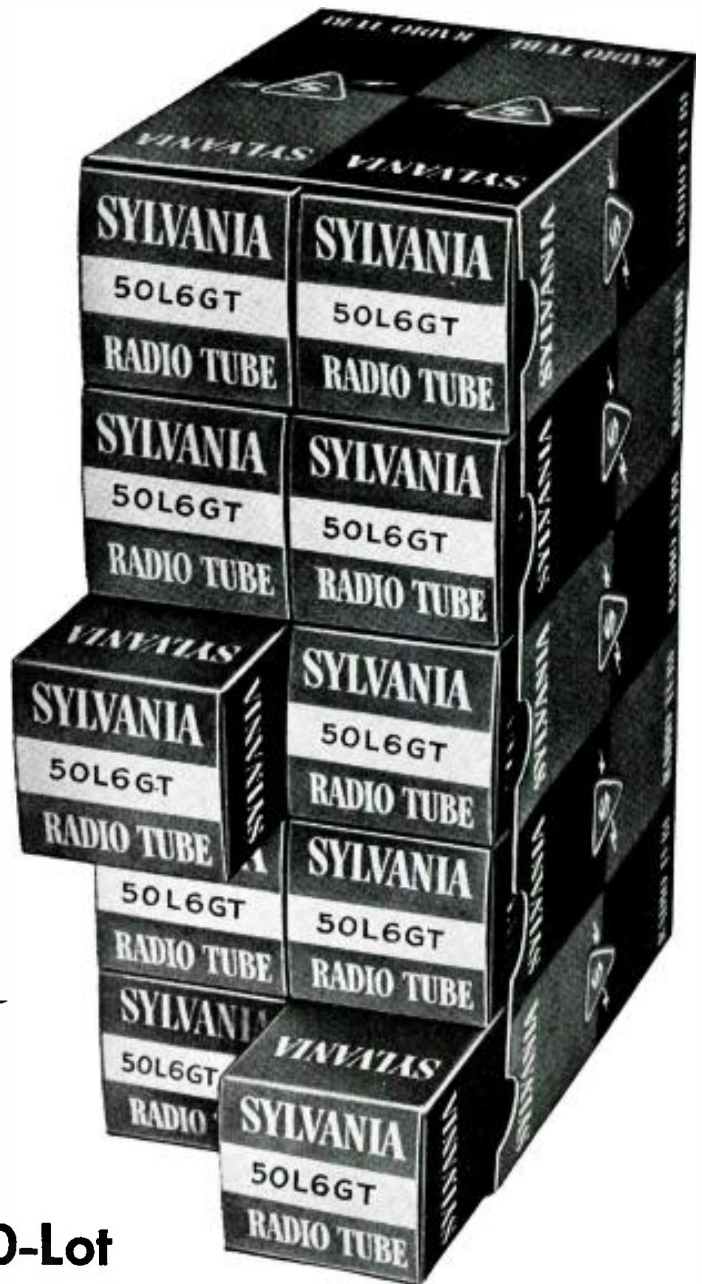
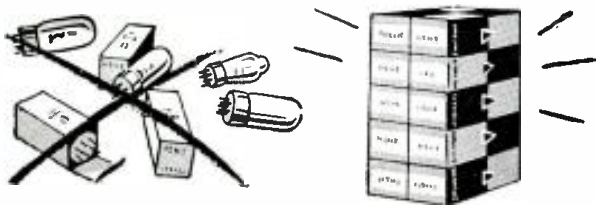

with Sylvania's New 10-Lot

Cartons of *fastest-moving* radio tubes!

HERE'S the new, handy 10-lot package, developed by Sylvania to make your job easier! You save time, you save money by keeping plenty of fast-moving tube types *on hand*. No need to make numerous trips to your distributor to buy a few tubes at a time—especially when you're just one type short on a service job!

This new package is easy to handle, easy to stock—no more loose tubes and cartons to take

up unnecessary space! Now your shelves will be neatly arranged, making it possible to store more tubes in the same space. Buying Sylvania tubes the 10-Lot Carton way simplifies your inventory and re-ordering job since you can inventory on the basis of 10 and re-order the same way! See your Sylvania Distributor today for any further details! *Sylvania Electric Products Inc., Radio Division, Emporium, Pa.*

SYLVANIA  ELECTRIC

Audio Impedance Matching

Part III—How to calculate loads and construct output transformers

By WALTHER RICHTER*

IN the preceding part of this article (March issue) we laid down the specifications for matching transformers, as far as the impedance transformation is concerned. We shall now see how these transformers can be constructed or picked out from a number of available units. We shall take two examples, a transformer to make a 20-ohm voice coil look like 53.4 ohms, and a multitap matching unit.

The impedance transformation ratio is equal to the square of the turns ratio. The turns ratio required for an impedance transformation is therefore equal to the square root of the impedance ratio. To make 20 ohms look like 53.4 ohms requires an impedance transformation ratio of 2.67. The square root of this is 1.63. This is the

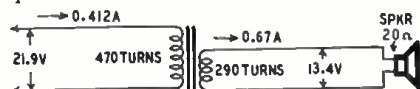

Fig. 1—Specifications, standard transformer.

turns ratio of the required transformer.

But the turns ratio does not completely describe a transformer. We also must know how much voltage will be applied across the primary terminals, its frequency, and how much current will flow in the windings. The voltage across the 16-ohm winding of the output transformer, with the 30-watt amplifier operating at full power and properly loaded, was calculated at 21.9 volts (see March article). This voltage applied to 53.4 ohms results in a current of 0.412 ampere. The voltage on the 53.4-ohm secondary will be 13.4 volts (using the turns ratio of 1.63) and the current will be 0.67 ampere. Fig. 1 shows the specifications of the transformer.

While space does not permit a detailed discussion of transformer design, we can give enough information to permit the sound man to make such a transformer on short notice.

As far as wire size is concerned, it is common practice in the design of small power transformers to allow approximately one circular mil per milliamper; in audio work this is more than ample, since most of the time transformers run considerably below full output. A standard wire table shows that No. 24 wire will be satisfactory for the primary and No. 22 wire for the secondary. Larger wire for one or both windings (provided there is sufficient space for the required number of turns)

will, of course, be more satisfactory.

The number of turns required depends on the cross-sectional area of the core, the maximum flux density decided on, and the lowest frequency at which the transformer must operate. The formula on which all turns calculations are based is

$$E = 4.44 \times \phi \times n \times f \times 10^{-8} \text{ volts,}$$

where

ϕ is the maximum amplitude of the alternating flux pulsating through the coil, in maxwells or magnetic lines;

n is the number of turns;

f is the lowest desired frequency.

If we wish to find the number of magnetic lines necessary to induce 1 volt in a single turn, we simply solve this formula for ϕ , substituting 1 for E , 60 cycles for f , and 1 for n . The result is 375,000 lines. This is one of the handiest figures to keep in mind, because all transformer calculations become easy with the aid of it.

The relation may be stated in words as follows: If we wish to apply or induce in a single turn 1 volt at a frequency of 60 cycles, a magnetic flux must pulse through it with a peak value of 375,000 lines. For any other frequency, this value of 375,000 lines must be increased or decreased in the inverse ratio of the desired frequency to 60 cycles. Thus, if we wish to go down to 30 cycles per second, a magnetic flux with a peak value of 750,000 lines is required through one turn to induce 1 volt.

A practical problem

Let us assume now that we have available a core with E-shaped laminations, with a center leg $\frac{3}{8}$ inch square. With the laminations built up in a square stack, the cross-sectional area of the core will be 0.765 square inch. Because of the insulating varnish, only about 95% of this area, or 0.7 square inch, is actually iron.

The maximum magnetic flux which this core can carry is equal to the maximum permissible density in lines per square inch times the cross-sectional area of the iron. In power-transformer design, even for small ones, densities of 60,000 to 75,000 lines per square inch are not uncommon. Such high values require fairly large magnetizing currents, however, which should be avoided in audio transformers. The density should preferably be kept at a lower value, perhaps 50,000 lines per square inch. This multiplied by the area of 0.7

gives 35,000 lines as the maximum flux which should be permitted to pulsate through the core. But, since at 30 cycles it takes a flux of 750,000 lines to produce 1 volt in 1 turn, a flux of 35,000 lines will produce $35,000/750,000 = .0465$ volt. This is consequently the voltage per turn; the primary winding, which is to operate with 21.9 volts, must therefore have $21.9/.0465 = 470$ turns, while the secondary side will have to have 290 turns.

It remains to be checked whether this amount of copper can be accommodated within the window. If not, the stack height must be increased, which increases the maximum flux the core can carry and consequently increases the volts per turn, with a corresponding reduction in the number of turns required; or the next larger size of lamination may be used.

The amount of copper and the space required for it can be considerably reduced if an autotransformer is constructed. In addition, since 100% coupling exists at least between parts of the primary and secondary of an autotransformer, it has better high-frequency response and better regulation than a two-winding transformer. The fact that in an autotransformer there is no isolation between the primary and secondary is of no consequence in the case of a matching transformer of the type discussed here.

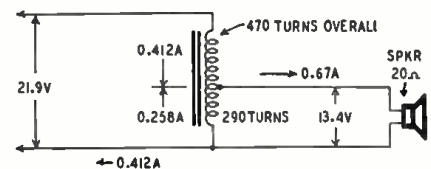

Fig. 2—An autotransformer may save space.

The two-winding transformer shown in Fig. 1 can be converted to an autotransformer simply by making the secondary winding part of the primary winding, so to speak. The transformer will then consist of the single winding of 470 turns, tapped at 290 turns (Fig. 2). The current which will flow in that part of the coil which is common to the primary and secondary circuits will be the algebraic sum of the two currents shown in Fig. 1. Since the direction of the current flowing in the secondary winding of a transformer is opposite to that of the current flowing in the primary winding, the algebraic sum will be only 0.258 ampere in the part of the winding common to both the primary and secondary. This permits the reduction of the wire size of this part of the

* Engineering and Development Dep't, Allis-Chalmers Mfg. Co.

winding; in this case No. 26 wire would be large enough. The arrangement will result in a considerable reduction in the space requirement for the windings, compared to the two-winding transformer shown in Fig. 1. The superiority of the autotransformer is quite important when the turns ratio is between 2 to 1 and 1 to 1. For higher turns ratios, such as 10 to 1, the saving in space is not very significant.

Matching six speakers

As the second design example a single transformer matching all the speakers shown in the March article to the 500-ohm line will be discussed. It was calculated that the 500-ohm speaker taking 7 watts, the 20-ohm speaker taking 9 watts, and the four series 6-ohm speakers taking 3.5 watts each had to appear to the 500-ohm tap on the output transformer as 2,140, 1,670, and 1,070 ohms, respectively. These are impedance ratios of $2140/500 = 4.28$, $1670/20 = 83.5$, and $1070/24 = 44.6$. The square roots of these figures give us the turns ratios 2.07, 9.14, and 6.68, respectively.

A common matching transformer supplying power to all the speakers is again best designed by considering it as the composite of three individual transformers. In Fig. 3 are shown the three individual transformers with the ratios just calculated. The current in the secondary windings will be the primary current divided by the turns ratios.

The primary windings of all three transformers are in parallel with the same voltage across them. If the transformers were constructed with cores of identical size, the number of primary turns would all be the same. The three windings can just as well be placed on a single core, making one winding out of them, and increasing the wire size. The combined primary current is 0.245 ampere, for which No. 26 wire will be satisfactory.

Since the finished transformer must handle 30 watts, we will need a fairly large core, especially if the frequency response is to be good down to 30 cycles. Suppose we can lay our hands on some E-shaped laminations with the center leg 1 1/4 inches wide. Following the procedure outlined in the preceding example and assuming a square stack, the voltage which a single turn can produce at 30 cycles, with the density in the iron not exceeding 50,000 lines per square inch, will be .099, or roughly 0.1 volt. This will require 1,225 turns for the primary winding for the 122.5 volts which will appear across the 500-ohm primary at 30 watts.

Instead of providing three separate secondary windings, as shown in Fig. 3, we can use the autotransformer, simply providing one continuous winding, tapped at places corresponding to the turns ratios given in Fig. 3. Since the various parts of this continuous winding carry different amounts of current, they may be wound with different sizes of wire, unless the window in the lam-

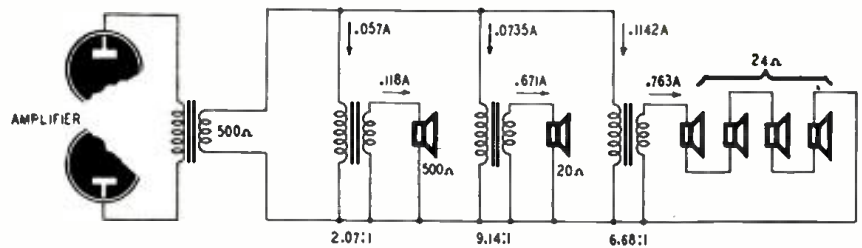

Fig. 3—This separate-transformer hookup can be matched back to tubes or line transformer.

inations is sufficiently large to accommodate one continuous winding of the largest wire required. The specifications for the complete matching transformer, based on a 1 1/4 x 1 1/4-inch stack, are shown in Fig. 4. The reader should have no difficulty convincing himself that this is simply the result of superimposing upon each other all the windings shown in Fig. 3. The currents in the various sections of the transformer, also indicated in Fig. 4, are found by superimposing the current values shown in Fig. 3.

The calculations can be checked for accuracy. The total ampere turns in a transformer—assuming zero d.c. mag-

netizing current, as we have done in this example—must come out as zero. Multiply the current in each section by the number of turns in this section, adding those in a downward direction and subtracting those in the opposite direction. A correct design will result in zero, within the limits of the accuracy of the calculations.

put signal can be avoided by replacing the speaker which is to be taken out of service by a dummy load resistance equal to the voice-coil impedance which was removed. This will of course require a double-throw switch.

The designers of negative-feedback amplifiers often demonstrate with pride the fact that they can connect an 8-ohm speaker to either the 4-ohm, 6-ohm, or 20-ohm tap without noticeable change in volume. If the feedback voltage happens to be taken from the output terminals, such a performance is not at all surprising, since the feedback is essentially a device to keep the output voltage constant regardless of any changes which may have taken place in the amplifier; and a change of the output tap can of course be considered as a change in the over-all amplification from the input terminals to the output terminals. Such a demonstration is quite misleading, because it usually is not made under maximum output conditions. If it is, it will become quickly apparent that, feedback or no feedback, distortion will set in earlier if the load does not have the value recommended by the manufacturer for the particular type of tube used in the output stage.

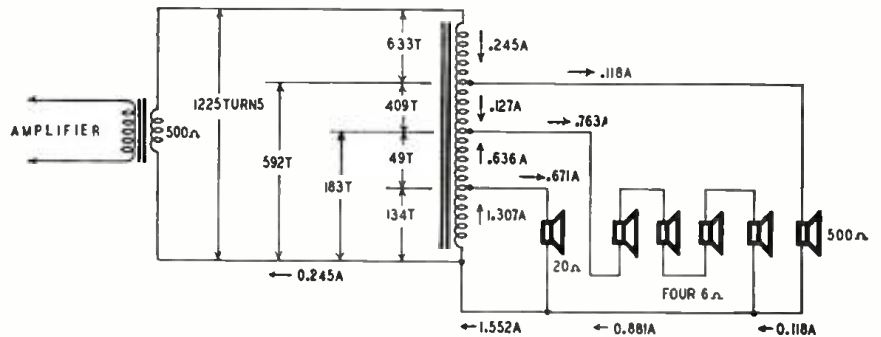

Fig. 4—How the several speakers of Fig. 3 can be fed from a single output transformer.

netizing current, as we have done in this example—must come out as zero. Multiply the current in each section by the number of turns in this section, adding those in a downward direction and subtracting those in the opposite direction. A correct design will result in zero, within the limits of the accuracy of the calculations.

If the 1 1/4-inch laminations happen to be of one popular (the "scrapless") type, the window for the coil will be found to have dimensions of 5/8 x 1 7/8 inches. This will be ample to accommodate the windings without having to cut each size wire down to the exact requirement given by the current flowing in it. The 183 turns carrying the heavy currents may be wound of No. 19 wire and can be accommodated in five layers. The remaining 1,042 turns can be accommodated in 11 layers of No. 26 enameled wire. If wound reasonably tight, the finished winding will fit nicely into the available space.

Changing the load

Will it be permissible to disconnect any one of the speakers with an on-off switch? Naturally, that will mean that the total load presented to the amplifier

SWEEP GENERATOR

Precision Apparatus Co.,
Elmhurst, N. Y.

Series E-400 offers wide- and narrow-band sweep selection for FM and television alignment. Frequency coverage is continuous from 2 to 240 mc in five



bands. Sweep ranges are 0-1 and 0-10 mc. A direct-reading dial has two-color scales; a vernier reads to 1 part in 1500.

TAPE RECORDER

Crestwood Recorder Corp.,
Chicago, Ill.

The MagicTape recorder has a two-channel feature which allows recording of a full hour's material on a standard half-hour tape. Frequency range is from



50 to 8,000 cycles. Rewind time is less than 1½ minutes for a half-hour reel. The unit is portable, weighing 25 pounds, including microphone and an extra reel of tape.

NEON PILOT LIGHT

Industrial Devices, Inc.,
Edgewater, N. J.

The Tiny-Glow, a rugged and dependable pilot light consisting of a neon lamp enclosed in a chrome-plated housing, may be used over a range of 75 to



250 volts and is guaranteed for a minimum of 10,000 hours' use. Power consumption is about 0.1 watt. It is said to operate more reliably under vibration than spring-contact lamp assemblies because all connections are firmly soldered.

KEYING RELAY

Sigma Instruments, Inc.,
Boston, Mass.

Type 7 J0Z is a sensitive, polarized keying relay for measuring high-speed telegraphy, measuring 1½ inches square by 2¾ inches high when seated. Hermetically sealed, it fits an octal tube socket. It is serviceable up to 250 w.p.m.

INK RECORDER

Sound Apparatus Co.,
Stirling, N. J.

Model FRA is a fully automatic recorder which plots a curve of any changing quantity that can be converted into an a.c. or d.c. voltage. Measuring ranges may be selected and recorded on either a logarithmic or linear scale. Typical applications are in sound, strain or pressure, and r.f. field-strength measurements.

The instrument is available in 56 double chart speed combinations from 45 inches per minute to ½ inch per hour and for frequencies from 2 to 200,000 cycles. It is supplied with a standard 10½-inch relay-rack panel, by which it may be mounted in any standard relay rack.

**KILOVOLT METER**

Bradshaw Instruments Co.,
Brooklyn, N. Y.

Model 4,000 is designed to measure television and X-ray voltages up to 50,000 d.c. It has a 20 µm meter and an input impedance of 1,250 megohms. Basic sensitivity of the instrument is 50,000 ohms per volt. For safety, all voltages are dissipated in the polystyrene probe, test leads are shielded, and the shields are connected together. A NORMAL-REVERSE key is provided so that the probe may be used regardless of the polarity of the voltage being measured.

REPLACEMENT SPEAKER

Quam-Nichols Co.,
Chicago, Ill.

Model 69A2 Adjusto-Cone speaker is designed for replacement in automobile receivers. Because of its shallow

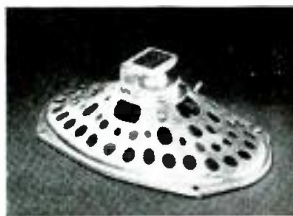

construction, it will fit most auto receivers, regardless of make, so that the technician need stock only the one type for most cars.

MOBILE AMPLIFIER

Newcomb Audio Products Co.,
Hollywood, Calif.

Model E-10-M is a rugged low-cost amplifier usable on either 6-volt d.c. or 117-volt a.c. Power output is 10 watts with less than 5% distortion; frequency response ranges from 50 to 10,000 cycles. Five tubes are used, a 6SC7, a 6SF5, two 6V6-GT's, and a 6X5 GT.

A standby switch is included to save battery power when the amplifier is used intermittently.

**TV TRANSFORMERS**

Chicago Transformer Division
Essex Wire Corp.,
Chicago, Ill.

A new line of transformers for television receivers is now available from stock for manufacturers and technicians. Included are power, vertical blocking-oscillator and vertical scanning output transformers and a horizontal scanning output transformer.

SERVICING MIRROR

Federal Engineering Co.,
New York, N. Y.

Many television service technicians feel that only a gaffole is built for the job of adjusting the rear-panel controls of a receiver for the best picture. Neck craning is eliminated by the Picture-Vu, a portable mirror and its collapsible metal stand. The stand is unfolded and set on the floor in front of the receiver. The unbreakable 14 x 10-inch mirror is removed from its cloth bag and hooked to the stand. The technician makes his adjustments in comfort, watching the reflection in the mirror.

**WHEATSTONE BRIDGE**

Leeds & Northrup Co.,
Philadelphia, Pa.

The Enclosed Switch Wheatstone bridge, offered previously in a mahogany case, is now housed in a gray, baked-enamel, metal case. Other instruments made by this company will change from wood to metal boxes as soon as engineering is completed.

**RECORD PLAYER**

Scott Radio Laboratories, Inc.,
Chicago, Ill.

The three records now available—Columbia's 33 1/3-r.p.m. LP, Victor's 45-r.p.m., and the 78-r.p.m. standard—may be played on this assembly. Two pickups are provided, one for the slow-speed and the other for standard discs. Standards are played automatically, the others manually. A brass collar which may be slipped over the spindle provides for the 1½-inch center hole of the Victor records. The player is an adaptation of the Thorens changer, made in Switzerland and widely used in Scott radio-phonographs. The turntable is governor-controlled.

RECORD CHANGER

Farnsworth Television & Radio Corp.,
Fort Wayne, Ind.

The new record changer will play all three sizes—12-, 10-, and 7-inch—records automatically, with intermixing of 10- and 12-inch discs permissible. Two speeds are provided, 78 and 33 1/3 r.p.m., each of which is automatically switched in when the correct pickup is inserted. The standard and micro-groove pickups are easily exchanged.

INPUT TRANSFORMER

United Transformer Corp.,
New York 13, N. Y.

A new transformer designed to match a low-impedance (50-500 ohm) microphone or pickup to a grid is equipped with built-in phone plug and jack. The transformer is plugged into the micro



phone or phono jack on the amplifier, and the cable from the mike or pickup is plugged into the transformer. Frequency range of the transformer is 50-10,000 cycles, and hum pickup is low.

MICROPHONE STAND

Electro-Voice, Inc.,
Buchanan, Mich.

Model 432 microphone stand, built in three sections, can be used as a banquet stand, set at chair height, or extended to full height for standing speakers. The unit is easily portable, but stable. It has the "red button" height control, which allows change of height without necessity for twisting lock-fittings.

**CUEING DEVICE**

Amplifier Corp. of America,
New York, N. Y.

The E-Z-Cue tape and wire indexer is a counter actuated by rotary motion. A flexible shaft extension is placed over the spindle of either the supply or the take-up reel of almost any wire or tape recorder. The counter registers the number of revolutions so that any section of the wire or tape may be identified and located. Average accuracy is within about 1 second on standard spools.

**SHIELDED LINE**

Federal Telephone and Radio Corp.,
Clifton, N. J.

A new 300-ohm, balanced, shielded line minimizes noise, ghosts, and snow



on the television screen due to transmission line pickup, often eliminating the need for more elaborate antennas. The K-III line has two inner conductors—crimped at intervals to keep it rigid with respect to the inner tube of insulating material—a shield, and an over-all covering.

ISOLATION UNITS

Chicago Transformer Division,
Essex Wire Corp.,
Chicago, Ill.

Three new isolation transformers with 50, 150, and 250 volt-ampere ratings are available. They are suitable



for adjusting line voltage or isolating a.c.-d.c. chassis from the line for safety. Secondaries will provide 105 or 125 volts for testing, as well as the standard 115.

ELECTROLYTICS

Aerovox Corp.,
New Bedford, Mass

Stud terminals are used in place of the usual rivet terminals in the new PRS midget dual electrolytic capacitors. These allow a reduction of as much as 40% in the size of the capacitors. Dimensions of the new Dual Dandees range

from 11/16 to 1 1/16 inches against a previous single size of 1 1/16 inches. Illustration shows new and old types.

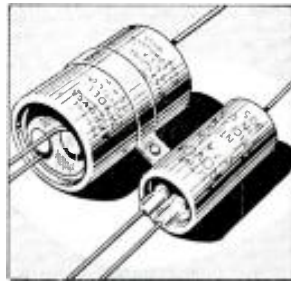

PRECISION RESISTORS

Welwyn Electronic Components,
Inc.,
New York, N. Y.

New "cracked carbon" resistors manufactured in England are being introduced in this country. The resistance element is a homogeneous film of pure carbon deposited on a porcelain tube. The resistors are unusually stable, according to the maker, and may be expected to adhere to their 1% tolerance throughout their service life. Two- and five-percent tolerances are also available; all may be had in 1/4-, 1/2-, 1-, and 2-watt sizes.

MOBILE CONVERTER

Gonset Co.,
Burbank, Calif.

Model 3-30 is a compact converter which, when used with an automobile broadcast receiver, allows reception of signals between 3 and 30 mc. The converter is powered by the supply in the auto set. A switch on the panel connects the regular car antenna to either the converter or the receiver. A bandspread dial permits logging.



Alliance Ten-na-Rotor illustrated with Amph enol 114-005 antenna.

**AMPHENOL ANTENNAS
GIVE HIGHEST GAIN!**



Where TV broadcasting stations are at wide angles from point of reception and re-orientation of the antenna is required to maximize each station, Amphenol television antennas provide the greatest gain by virtue of the in-line high and low band folded dipoles which beam in a clean, narrow directional pattern. The high front-to-side and front-to-back ratios not only provide maximum signal pickup in the exact desired direction, but also secure against any interference from an unwanted direction.

Durable, sturdy, aluminum construction withstands high wind and ice loading combined.

Install Amphenol in single bay or stacked array.

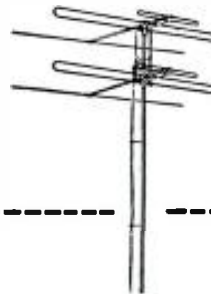

Illustrated at left is the standard Amphenol television antenna shown in stacked array (Model 114-302) for added db gain in fringe areas... or each bay may be individually oriented.



Model 114-005 at right is the standard Amphenol All-Channel TV Antenna with brilliant reception on all channels in both bands.



AMERICAN PHENOLIC CORPORATION
1830 SO. 54TH AVENUE • CHICAGO 50, ILLINOIS

**REVOLUTIONARY
LOW PRICE!**



ONLY \$28.50
For Open Face Model

**HI - MEGOHM
MULTITESTER**

20,000 OHMS PER VOLT METER
SENSITIVITY

Accurate HIGH RANGE OHM-METER 1000 megs requires NO batteries and NO tubes. Voltage Multipliers, Shunts and other close tolerance resistors are hand-matched for accuracy within 1%. All meters have an accuracy within 2%—4 1/8" meter gives highly desired legibility and calibration accuracy. Uses germanium crystal rectifier for AC measurements. No errors due to frequency within 100 megacycles. No errors due to temperature changes. Substantially constructed, attractive natural finish oak case—panels are BONDORIZED for hard service and long wear—attractive hamertone grey background with white lettering—Battery drain is very low. Instantly replaces in a snap grip holder with snap tight contact. Portable model includes a pair of deluxe test leads. Open face 8 7/8 x 5 1/2 x 3 3/4 inches; weight 3 lbs. Portable model with latch and leather handle, 8 7/8 x 7 1/2 x 4 3/4 inches; weight 4 1/2 lbs.

frequency within 100 megacycles. No errors due to temperature changes. Substantially constructed, attractive natural finish oak case—panels are BONDORIZED for hard service and long wear—attractive hamertone grey background with white lettering—Battery drain is very low. Instantly replaces in a snap grip holder with snap tight contact. Portable model includes a pair of deluxe test leads. Open face 8 7/8 x 5 1/2 x 3 3/4 inches; weight 3 lbs. Portable model with latch and leather handle, 8 7/8 x 7 1/2 x 4 3/4 inches; weight 4 1/2 lbs.

MODEL	High Ohm Range	Other Ohms Ranges	Meter Sensitivity Ohms/Volt	D. C. Voltage Ranges	A. C. Voltage Ranges	Current Ranges D. C. Milliamps	Decibel Ranges	PRICE
450 C	1000	0-5000	20,000	0-5-50	0-10-100	0-0.1	-9 to	28.50
450 CP	MEG	5 MEG.		125-500-2500	250-1000	10-100-1000	+55	32.50

BUY FROM YOUR LOCAL JOBBER
Write for Bulletin No. 5C

RADIO CITY PRODUCTS CO., INC.

152 WEST 25th ST



NEW YORK 1, N. Y.

TRANSVISION TV KITS

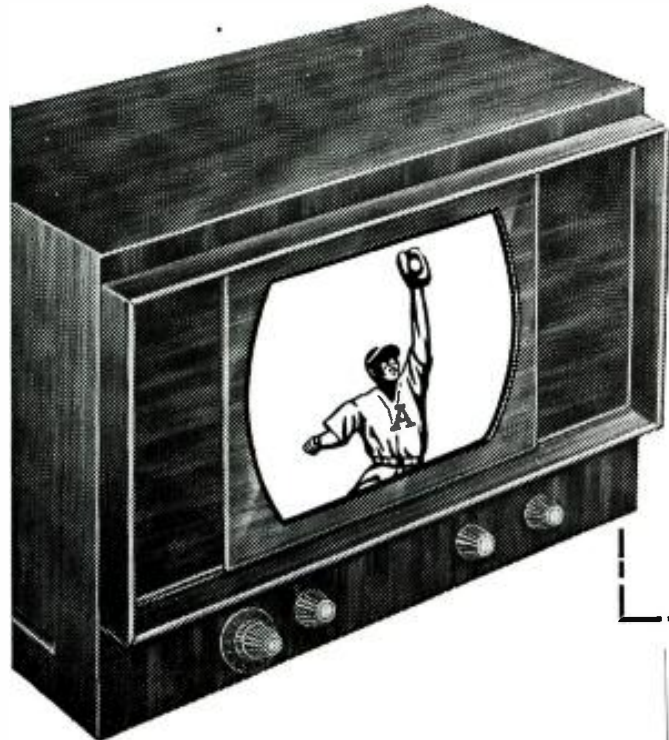

Special Offer

MODEL 12A TV KIT with 12 1/2" PICTURE TUBE

REMARKABLE VALUE!

\$239
less cabinet*

Here's what you get:

- FAMOUS TRANSVISION TELEVISION KIT, giving the finest television money can buy.
- 12 1/2" DIRECT-VIEW PICTURE TUBE
- FREE ANTENNA: INDOOR or OUTDOOR type, with lead-in wire. Either antenna gives ideal reception on all channels. Landlord's permission NOT required for indoor type.
- NO INSTALLATION COST. You can install assembled kit yourself in about an hour.



Indoor Antenna (shown at right) available separately for \$7.95



TRANSVISION Model 15-A TV KIT

This high-quality Transvision TV Kit has a 15" picture tube. In all other respects it is the same as the 12A shown above.

\$299 LESS CABINET*

***CHOICE OF BEAUTIFUL CABINETS from \$29**

For example, a "Modular" Console Cabinet, which can be easily assembled in about an hour, costs \$29.

ASSEMBLE Your Own CABINETS

Transvision's "MODULAR" Cabinets come in knock-down, unpainted units, offering an unlimited range of combinations, including even a bar. Finish them off to suit your taste and need.

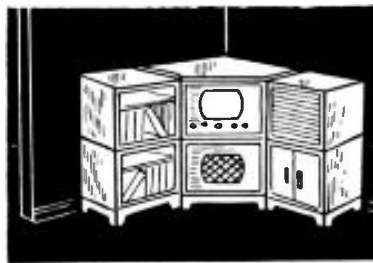

Corner piece, shown above, has room for TV, Phono, Record Storage, and open Book Case. COMPLETE \$84.00. For other units and prices, write for "Modular" Catalog.

FREE:
162 PAGE
TV COURSE

... with purchase of any Transvision TV Kit ... You don't need this course to assemble a Transvision Kit because the job is easy enough and our instruction sheet is simple and clear. BUT, if you want a good introduction to television fundamentals as a basis for further study, the Transvision Television Home-Study Course is ideal. Remember, you pay nothing extra for this course.



MODEL 12CL TV-FM KIT

200 sq. in. PICTURE TV-FM KIT MODEL 12CL

Has Du Mont inputuner
IMAGE IS EQUAL to that of a 20" tube— even sharper and clearer—visible from all angles.

EQUIVALENT OF \$1000 SETS

Price of the new Transvision 12CL electromagnetic kit includes these outstanding features:

- 12 1/2" picture tube with special fitted built-in All-Angle Lens and color kit.
- Du Mont TV-FM Inputuner.
- Streamlined Cabinet and Roto-Table.

Includes Cabinet, Lens, Table, Indoor or Outdoor Antenna. 60 ft. of Lead-in Wire.

\$399

All Transvision Prices are fair traded; subject to change without notice. Prices 5% higher west of the Mississippi.

TRANSVISION, INC., Dept. RE, NEW ROCHELLE, N. Y.

For FREE 20-page TV BOOKLET and CATALOG SHEETS, SEE YOUR TRANSVISION OUTLET!

NEW YORK, N. Y.
TRANSVISION OF MANHATTAN
75 Church St.

BROOKLYN, N. Y.
TRANSVISION OF BROOKLYN
485 Coney Island Ave.

LONG ISLAND, N. Y.
TRANSVISION OF LONG ISLAND
40-14 Greenpoint Ave.
Long Island City, N. Y.

NEWARK, N. J.
TRANSVISION OF NEW JERSEY
601 Broad St.

PHILADELPHIA, PA.
TRANSVISION OF PHILA.
235 North Broad St.

BOSTON, MASS.
TRANSVISION OF NEW ENGLAND
1306 Boylston St.

WASHINGTON, D. C.
STAR RADIO
409 11th St., N. W.

CHICAGO, ILL.
TRANSVISION OF CHICAGO
1002 South Michigan Ave.

SYRACUSE, N. Y.
TRANSVISION OF SYRACUSE
517 Butternut St.

MIAMI, FLA.
TRANSVISION OF FLORIDA
10 Northeast Third Ave.

DALLAS, TEX.
TRANSVISION OF TEXAS
700 Commerce St.

HOLLYWOOD, CALIF.
TRANSVISION OF CALIF.
8572 Santa Monica Blvd.

SAN FRANCISCO, CALIF.
TRANSVISION OF CALIF.
3471 California St.

CANADA
TRANSVISION OF CANADA
465 Church St.
Toronto, Ontario

TRANSVISION TV INSTRUMENTS



ELIMINATE the VARIABLES in Television Installation with the TRANSVISION FIELD STRENGTH METER IMPROVES INSTALLATIONS!! SAVES 1/2 THE WORK!!

Has numerous features and advantages, including—(1) Measures actual picture signal strength . . . (2) Permits actual picture signal measurements without the use of a complete television set . . . (3) Antenna orientation can be done exactly . . . (4) Measures losses or gain of various antenna and lead-in combinations . . . (5) Useful for checking receiver re-radiation (local oscillator) . . . (6) **12 CHANNEL SELECTOR** . . . (7) Amplitudes of interfering signals can be checked . . . (8) Weighs only 5 lbs. . . . (9) Individually calibrated . . . (10) Housed in attractive metal carrying case . . . (11) Initial cost of this unit is covered after only 3 or 4 installations (12) Operates on 110V, 60 Cycles, A.C. Model FSM-1, with tubes Net \$99.50



NEW LOW PRICE TRANSVISION ALL-CHANNEL TELEVISION BOOSTER
CONTINUOUS TUNING

To assure television reception in weak signal areas, or areas which are out of range of certain broadcasting stations, Transvision engineers have designed this new booster. It increases signal strength on all television channels. Tunes all television channels continuously. Can be used with any type of television receiver. Unusually high gain in upper television channels.
Model B-1 List \$32.50

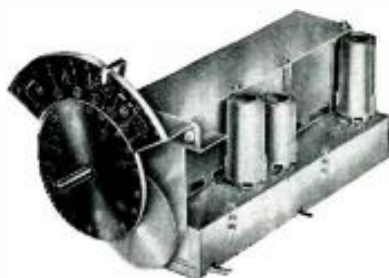

DuMont TV-FM INPUTUNER

The finest TV-FM Tuner on the market today! Distributed exclusively by Transvision.

- Covers all 12 channels, entire FM range.
 - Continuously tunes from 44 to 216 mc without a break. Requires no band switching for tuning from channel to channel.
 - Complete with tubes and escutcheon.
- Model IT-1 List \$59.95

TRANSVISION ALL-ANGLE LENSES for ALL TV SETS

Give picture sizes up to 150 sq. in. Exclusive patented feature makes image visible from wide angle. Lenses come with adapter for installation on ANY 7" or 10" picture tube, and with color kits.
All-Angle Lens for 7" tubes (gives 75 sq. in. picture), \$25.95. All-Angle Lens for 10" tubes (gives 150 sq. in. picture), \$37.50.
For 12 1/2" tubes, \$49.50



GET INTO the TV BUSINESS In a BIG WAY with the TRANSVISION DEALER PLAN
WRITE FOR FOLDER D-1



TELEVISION and FM SWEEP SIGNAL GENERATOR

Complete frequency coverage from 0-227 MC with no band switching. . . . Sweep width from 0-12 MC completely variable. . . . Accurately calibrated built-in marker generator.
OUTSTANDING FEATURES: (1) Frequency range from 0-227 MC . . . (2) Dial calibrated in frequency . . . (3) Sweep width from 0-12 MC completely variable . . . (4) Self-contained markers readable directly on the dial to .5% or better. (No external generator required to provide the marker signals) . . . (5) Crystal controlled output makes possible any crystal controlled frequency from 5-230 MC. . . (6) Plenty of voltage output—permits stage-by-stage alignment . . . (7) Output impedance 5-125 ohms . . . (8) Directly calibrated markers, 20-30 MC for trap, sound and video IF alignment . . . (9) RF for alignment of traps for IF channels when a DC voltmeter is used as the indicating medium. . . (10) Unmodulated RF signal to provide marker pips simultaneously with the main variable oscillator . . . (11) Markers can be controlled as to output strength in the pip oscillator . . . (12) Power supply completely shielded and filtered to prevent leakage. . . (13) All active tubes are the new modern miniature type . . . (14) Phasing control incorporated in the generator . . . (15) Operates on 110V, 60 Cycles, AC.
Model SG Net \$99.50

REMOTE CONTROL UNIT KIT OPERATES ANY TELEVISION SET from a DISTANCE up to 50 feet.



Model TRCU Remote Control Unit Kit with 25-ft. cable \$69.00
Also available without cabinet 65.00

IF YOU ARE NOT NEAR A TRANSVISION OUTLET . . . USE THIS COUPON

MAIL TO: TRANSVISION, INC., NEW ROCHELLE, N. Y. RE-5

Please ship the following Transvision Products THROUGH YOUR NEAREST LOCAL OUTLET:—

I am enclosing 10% DEPOSIT in the amount of \$ _____, balance C.O.D.

() I want to get into the Television Business. Send me details of your Dealer Plan.

Name _____ City & Zone _____
(please print)

Address _____ State _____

LARGEST SURPLUS STOCK in the COUNTRY at the LOWEST PRICES!

DYNAMOTORS & INVERTERS

- BD-77 —Dynamotor Unit 14 1/2 in. 100v. 350 ma out with relay fuse box and filters. FOB Chicago only. \$5.75
- PE-101-C —Dynamotor unit: 12 or 24 in. outputs 800v, 20ma. 400v. 135ma. 9v. 1.1A 2.75
- PE-55 —Dynamotor unit: 12 1/2 in. 16 amp. 500v out. 200 ma. FOB Chicago only 3.75
- PE-206 —Inverter unit, rotary converted, 28v in. 80v at 500VA, 800 cy. out. FOB Chicago only 3.95
- DM-32A —Each 95c. Three for 2.00
- DM-53 —Dynamotor, used with the BC-733. 24v in. 240v, 60ma out. New. 2.95

SURPRISE PACKAGE

20 pounds assorted radio parts. A \$25.00 value for only **\$1.95**

OUTPUT TRANSFORMER

HI-FI. Used in Scott-made Navy receiver. Fully potted. Pri. 5000 ohms, output secondary 600 ohms (T, inverse feedback sec. 60 ohms (T). **\$1.49 ONLY**

PE-117 UNIVERSAL POWER SUPPLY

6 or 12v input; out. 145v and 90v, less vibrator, voltage regulator and rectifier tube; ideal mobile power supply unit; excellent condition. FOB Chicago only. Each **\$2.95**

BC-709 INTERPHONE AMPLIFIER

Ideal for aircraft, booster for telephones, etc. FOB Chicago only **\$3.49**

VHF TRANSCEIVER

Ideal substitute for SCR-522, freq. range 140-141 mc. crystal controlled, 10 watts. The receiver section has two individual IF sections, feeding a common 3 stage 10mc IF amplifier. Both IF sections may be operated simultaneously, or either one individually. The receiver unit has 13 tubes. The transmitter is of straight forward design. Transmitter unit has 7 tubes, one 2K32 as final modulated by a pair of 6L6 and push-pull. Complete unit in case with tubes, crystals and diagram less dynamotor. **\$14.95 EXCELLENT CONDITION**

New Phantom Antenna for above unit; 3 lamps in parallel with sockets, complete for **95c.**

SMASH VALUES IN COMMAND EQUIPMENT

- BC-452-EXC. \$12.95
- BC-454-EXC. \$3.95-NEW 4.95
- BC-455-EXC. 7.95
- BC-456-NEW 2.95
- BC-457-NEW 6.95
- BC-458-NEW 7.95
- BC-459-EXC. 9.95
- BC-896-EXC. 14.95

CONDENSER

2 MFD, 4000V, Pyranol **\$2.95 ea.**
4 for **\$10.00**

GEARED TUNING DIAL

5 band, vernier, BRAND NEW. Frequency range: 3.2-4; 6.4-8; 12.8-16; 19.2-24; 25.6-32. Ideal for many applications. An exceptional buy. **\$1.39**

APS-13 UHF ANTENNA

Suitable for 400 mc citizen band. Ideal for UHF experimenters. With director and reflector elements mounted. BRAND NEW. 2 for **\$1.49**

BC-659 TRANSMITTER-RECEIVER UNIT

FM transmitter-receiver, crystal controlled, two channels, freq. range 27-38.9 mc. 13 tubes 2 **\$16.95** crystals. NEW

BC-620 TRANSMITTER-RECEIVER UNIT

FM transmitter-receiver, crystal controlled, two channels, freq. range 20-27 mc. 13 tubes, dual meter for testing filament and plate circuits. Used. **\$9.95** good

Mobile Installation Kit for BC-659 or BC-620 consists of TS-13; MJ-18; 4 section whip antenna. **\$12.95** Insulators, 2 maintenance manuals; NEW

SPECIAL!

WESTINGHOUSE TRANSMITTER BC-122
Freq. range 325 to 800 KC; in portable field case; 3 meters plus excellent parts (less tubes)
—An Excellent Buy—BRAND NEW—\$7.95 ea.

All shipments FOB Chicago, or Los Angeles unless specified. 20% Deposit required on all orders. Minimum order accepted—\$5.00. California and Illinois residents, please add regular sales tax to your remittance.

ARROW SALES, INC., Dept. R

MAIN OFFICE:
1712-14 S. Michigan Ave., Chicago 5, Illinois

NORTH SIDE BRANCH:
1802 N. Humboldt Blvd., Chicago.

WEST COAST BRANCH:
1260 S. Alvarado, Los Angeles, Calif.

MICROWAVE MEASUREMENT

Patent No. 2,453,533

Lowell E. Norton, Princeton Junction, N. J.
(assigned to Radio Corp. of America)

When a waveguide carries microwave energy, its opposite faces are oppositely charged. Therefore these walls attract each other. If a small section of wall is removed and a fine screen substituted, a relatively large physical displacement occurs.

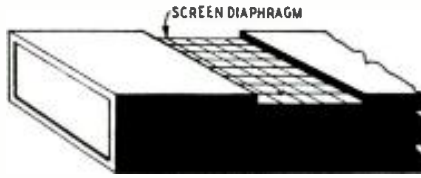

The screen should be light and resilient. It may have about 1,000 conductors per linear inch, and may be constructed by photodeposition. This screen portion acts like a diaphragm. Its displacement is maximum if the microwave energy is modulated or keyed at the resonant frequency of the diaphragm.

The screen carries a tiny mirror which throws light upon a photocell. Displacement of the diaphragm modulates this beam. Photocell output is amplified and indicated on a meter. A direct power reading is obtained when the instrument is calibrated.

ever, sufficient current output may be available to deflect a meter. In this invention the signal is used to deflect a sensitive galvanometer and modulate an r.f. voltage. The r.f. is easily amplified and then detected.

Referring to the diagram, the d.c. signal is connected to galvanometer G and resistor R in series. The meter pointer moves a metal vane between coils L. The coils and condenser C are tuned to approximately the same frequency as the r.f. voltage applied to the suppressor of the tube.

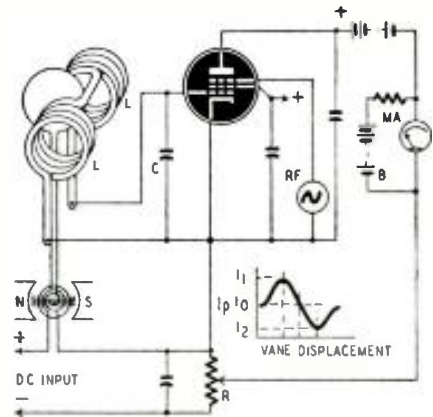

When a weak d.c. signal is applied, the resonant frequency of LC is changed because the vane is displaced. The average plate current then increases or decreases, as shown by the curve. If the galvanometer needle is deflected in one direction, for example, the current may rise from I_1 to I_2 . For a change in the opposite direction, there may be a drop from the normal current to I_2 . This change may be amplified in further stages before detection, although in this schematic, only one tube is used.

The plate current flows through MA, a recording or indicating meter, and then through part of R. This plate current may be several times greater than the original signal; but, by adjusting R, it is made to balance out the original. After each displacement the vane tends to return to its original position until there is another change in the input.

Battery B is used to balance out the static plate current I_1 , so that MA indicates zero with no input.

STONE CONTROL

Patent No. 2,444,076

Pierre Visschers, Antwerp, Belgium
(assigned to Int'l Standard Electric Corp.)

This tone control is used with a negative feedback circuit.

C1 and R3 are the high-frequency control components. As the movable arm is adjusted toward the upper end of R3, more high frequencies are bypassed through C1 to ground. Therefore the over-all h.f. response of the amplifier becomes weaker.

The negative feedback circuit from the speaker is composed of R1, R2, and R4. When the movable arm of R3 is adjusted toward its lower end, more highs are bypassed from the negative feedback line through C2 to ground. Then the degenerative effect is greater at low frequencies and highs are effectively boosted.

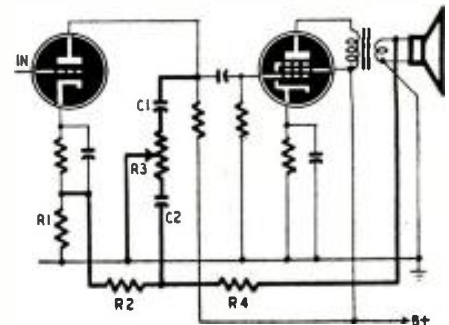

CRYSTAL OSCILLATOR

Patent No. 2,452,951

Donald E. Norgaard, Scotia, N. Y.
(assigned to General Electric Co.)

The series resonant frequency of a crystal governs the oscillations in this circuit. Holder capacitance and air gap have negligible effect. Plate and filament voltages also have comparatively little effect.

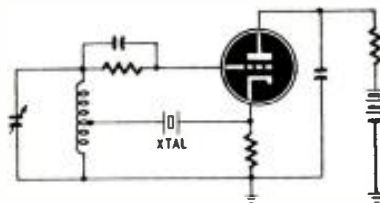

The crystal is connected in series with the coil tap and controls the feedback. Maximum feedback occurs with minimum impedance, that is, at the series resonant frequency of the crystal. This results in a more stable and precise oscillator than is usually obtained.

SECRET TRANSMISSION

Patent No. 2,455,443

David Sarnoff, New York City
(assigned to Radio Corp. of America)

This system preserves the secrecy of messages by using arbitrary symbols instead of letters, and transmitting by facsimile or television. The symbols are chosen for distinctiveness so that they can be recognized even if portions are lost due to noise or interference.

The code governing these symbols may be changed as often as necessary to insure secrecy. At the transmitting end, the teletypewriter may use a conventional keyboard with ordinary letters, but the corresponding symbols are printed. At the receiving end the machine prints letters but the keyboard may be marked with the corresponding symbols. If desired the receiving machine may be operated automatically by the incoming signals.

WEAK-SIGNAL AMPLIFIER

Patent No. 2,446,390

Karl Rath, New York, N.Y.
(assigned to Radio Patents Corp.)

Because of tube noise and other limitations it is very difficult to amplify a weak d.c. voltage such as is obtained from a thermocouple. How-

MONEY BACK GUARANTEE — We believe units offered for sale by mail order should be sold only on a "Money-Back-If-Not-Satisfied" basis. We carefully check the design, calibration and value of all items advertised by us and unhesitatingly offer all merchandise subject to a return for credit or refund. You, the customer, are the sole judge as to value of the item or items you have purchased.

BUILD YOUR OWN OSCILLOSCOPE and V.T.V.M. and SAVE!!



5" OSCILLOSCOPE KIT

Indispensable for AM, FM, and Television. Horizontal sweep circuit 15 to 30,000 cycles. All controls on front panel. Linear sweep with 884 gas triode. Graph screen for measuring peak to peak voltage. Frequency response of horizontal and vertical amplifiers from 50 cycles to 50 Kc. Input impedance 1 megohm and 50 mmfd. Etched panel for long life. Tube complement: 2-6SJ7, 2-5Y3, 1-884, 1-5B1P1. Provision for external synchronization, test voltage and intensity modulation. Deflection sensitivity: .30 volts per inch full gain. Detailed instructions and pictorial diagrams included. Operates from 105/-**\$39⁹⁵** 130 V.A.C. 50/60 cy. Nothing else to buy!

VACUUM TUBE VOLTMETER KIT

THE MOST USEFUL TOOL ON THE RADIO BENCH!

D.C. and A.C. ranges 0-5, 10, 100, 500 and 1000 volts. Ohm-meter ranges from .2 ohms to 1,000 megohms in steps of Rx1, Rx10, Rx1000, Rx10,000 and Rx1 megohm. Db scale from -20 to +55 Db in 5 ranges. Diode A.C. rectifier. Large rugged 4 1/2" meter with all A.C. and D.C. readings on one simple scale. 1% accuracy. Complete **\$23⁹⁵** tubes and test prods. Nothing else to buy!



THE NEW MODEL 670

SUPER METER



SUPER METER. A Combination VOLT - OHM - MILLIAMMETER plus CAPACITY REACTANCE, INDUCTANCE and DECIBEL MEASUREMENTS.

D.C. VOLTS: 0 to 7.5/15/75/150/750/1500/7500. A.C. VOLTS: 0 to 15/30/150/300/1500/3000 Volts. 0 U T P U T VOLTS: 0 to 15/30/150/300/1500/3000. D.C. CURRENT: 0 to 1.5/15/150 ma.; 0 to 1.5 Amps. RESISTANCE: 0 to 500/100,000 ohms. 0 to 10 Megohms. CAPACITY: .001 to .2 Mfd., .1 to 4 Mfd. (Quality test for electrolytics.) REACTANCE: 700 to 27,000 Ohms; 13,000 Ohms to 3 Megohms. INDUCTANCE: 1.75 to 70 Henries: 35 to 8,000 Henries. DECIBELS: -10 to +18, +10 to +38, +50 to +58.

The model 670 comes housed in a rugged, crackle-finished steel cabinet complete with test leads and operating instructions. Size 5 1/2" x 7 1/2" x 3". **\$28⁴⁰** NET

The New Model 770 — An Accurate Pocket-Size

VOLT-OHM MILLIAMMETER



(Sensitivity: 1000 ohms per volt)

Features: Compact-measures 3 1/4" x 5 7/8" x 2 1/4". Uses latest design 2% accurate 1 Mil. D'Arsonval type meter. Same zero adjustment holds for both resistance ranges. It is not necessary to readjust when switching from one resistance range to another. This is an important time-saving feature never before included in a V.O.M. in this price range. Housed in round-cornered, molded case. Beautiful black etched panel. Depressed letters filled with permanent white, insures long-life even with constant use. **Specifications: 6 A.C. VOLTAGE RANGES: 0-15/30/150/300/1500/3000 volts. 6 D.C. VOLTAGE RANGES: 0-7 1/2/15/75/150/750/1500 volts. 4 D.C. CURRENT RANGES: 0-1 1/2/15/150 Ma. 0-1 1/2 Amps. 2 RESISTANCE RANGES: 0-500 Ohms. 0-1 Megohms.** The Model 770 comes complete with self-contained batteries, test leads and all operating instructions. **\$13⁹⁰** NET

THE NEW MODEL 777

20,000 OHMS PER VOLT!! TUBE & SET TESTER

Tube Tester Specifications:

★ Tests all tubes including New Miniatures, etc. Also Pilot Lights. ★ Tests by the well-established emission method for tube quality, directly read on the scale of the meter. ★ New type line voltage.



V.O.M. Specifications:
 * D.C. VOLTS: (at 20,000 Ohms Per Volt), 0 to 7.5/15/75/150/750/1,500 Volts.
 * A.C. VOLTS: (At 10,000 Ohms Per Volt), 0 to 15/30/150/300/1,500/3,000 Volts.
 * D.C. CURRENT: 0 to 1.5/15/150 Ma. 0 to 1.5 Amperes.
 * RESISTANCE: 0 to 5,000/50,000/500,000 Ohms. 0 to 50 Megohms.
 Model 777 operates on 90-120 volts 60 cycles A.C. Housed in beautiful hand-rubbed cabinet. Complete with test leads, tubes, charts and detailed operating instructions. Size 13" x 12 1/2" x 6". **\$59⁹⁵** NET

The Model 88 — A COMBINATION

SIGNAL GENERATOR AND SIGNAL TRACER



*Frequency Range: 150 Kilocycles to 50 Megacycles. *The R.F. Signal Frequency is kept completely constant at all output levels. *Modulation is accomplished by Grid-blocking action which is equally effective for alignment of amplitude and frequency modulation as well as for television receivers. *R.F. obtainable separately or modulated by the Audio Frequency.

Signal Tracer Specifications:

*Uses the new Sylvania 1N34 Germanium crystal Diode which combined with a resistance-capacity network provides a frequency range of 300 cycles to 50 Megacycles. **\$28⁸⁵** NET

The Model 88 comes complete with all test leads and operating instructions. ONLY

20% DEPOSIT REQUIRED ON ALL C.O.D. ORDERS

GENERAL ELECTRONIC DISTRIBUTING CO. DEPT. RC-5, 98 PARK PLACE, NEW YORK 7, N. Y.

FM Set Installed in Car

An FM installation in your car can give you better sound, less noise

By MAX ALTH

THE shape of FM things to come was outlined in miniature by Andrew's Radio Service Company of Yonkers, N. Y., when Andy, at the behest of Harry Taubin, of the Bronx, installed an FM tuner in the latter's '47 Buick.

While this is by no means the first FM installation in a car, this is the first FM broadcast receiver installation of which this writer has heard. The forecast is that auto radios of the near future will incorporate an FM band, or even possibly be designed for FM reception only.

The results, Mr. Taubin relates, are satisfactory. The quality of reception is very good in town, and is satisfactory up to about 35 or 40 miles from the city, at which distance ignition noise begins to compete with the signal. However, Mr. Taubin could not drive very much further from town without losing considerable AM signal, either. It is only the fact that there are other AM stations along the way that enables him to receive AM programs over a greater road distance than FM signals. When FM stations increase in number, as they are doing right along, it is conceivable that FM auto receivers will supplant AM sets entirely.

FM reception in the city is considerably superior to AM reception, Mr. Taubin reports. Noise is less, sound quality is better and—this is, of course, a personal point of view—the FM programs are better.

The installation consists of a converted Meissner 8C FM tuner feeding the audio section of the Buick auto receiver.

Surprisingly enough, the regular AM antenna already installed in the car is used. The only change is a reduction in antenna length for FM use. It has been found that maximum FM signal is picked up with the antenna extended half way. Since there is sufficient AM signal strength in the city, the antenna is left half extended all the time the car is in town, for reception of both AM and FM.

Converting tuner and receiver

The conversion of the FM tuner from 117 volts a.c. to 6 volts d.c. is simple. The 6X5 rectifier tube is removed; the transformer and power wiring are left in place for future use.

An octal plug is wired to the car radio. Ground is connected to pin 2, the high side of the 6-volt battery to pin 7, and B-plus to pin 8. When this plug is

inserted into the tuner's 6X5 socket, filament and plate voltages are furnished the tuner, as shown below. Disconnect the high side of the tuner's filament transformer from the filament circuit. Remove the on-off switch (part of the tuner's volume control) from the transformer primary and connect it in the filament circuit, as in the diagram. Disconnect the shielded wire leading to

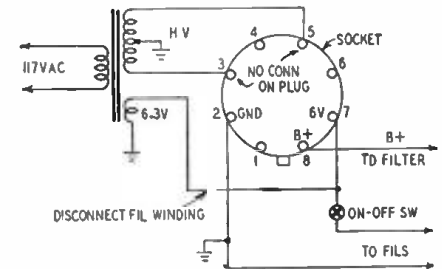

Power cable plugs into original 6X5 socket.

the grid of the 6C4 output tube from the arm of the volume control and solder it permanently to the high side of the control so that volume will always be maximum.

The tuner is mounted in the car by means of two home-made metal brackets. These are bolted to the fire wall of the car and to the sides of the wood cabinet that houses the tuner. The cabinet is strong enough for this purpose. A hole is drilled in one of the brackets, and an antenna-change-over toggle switch is mounted here. A receptacle for the plug on the end of the antenna lead-in is mounted next to the switch, and a length of shielded antenna wire is run from the switch to the AM-set antenna input.

A hole is drilled in the side of the AM set, through which the power leads to the tuner are brought. The AM detector output is disconnected from the volume control and connected to one end contact of a toggle switch. A lead is run from the other end contact through a length of shielded wire to a female bayonet socket. This takes the FM audio output via the plug that comes with the tuner. The center contact is wired to the a.f. amplifier of the AM set. The toggle switch is mounted on the side of the AM set, permitting the AM audio amplifier to be connected to either the FM or the AM signal. The volume control of the AM set, up on the dash of the car, controls the volume of either.

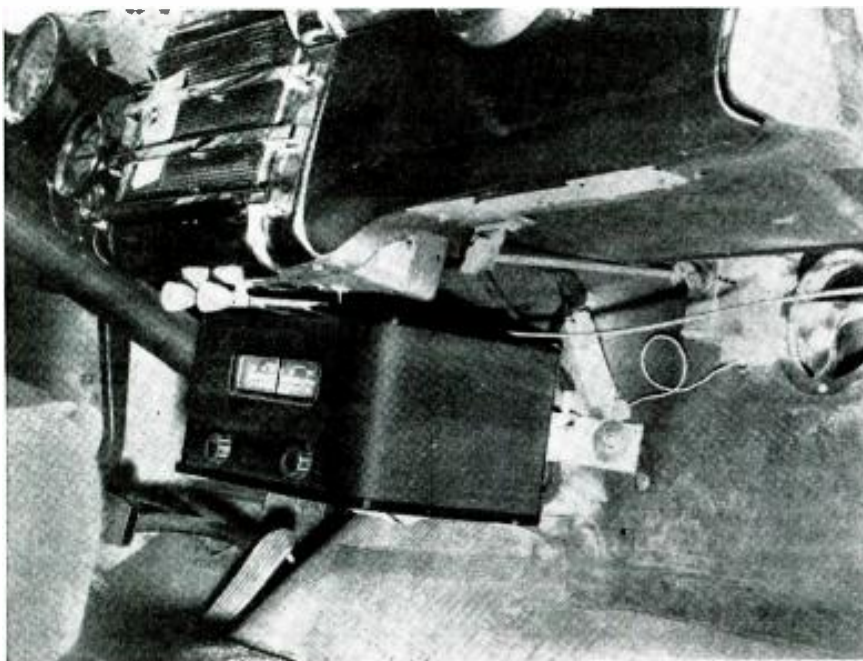

The tuner is mounted beneath the regular car radio where the driver can easily adjust it.

To operate the AM receiver, the set is turned on, and the audio and antenna toggle switches are thrown to the AM side. The on-off switch turns the tuner filaments off, as they are not used.

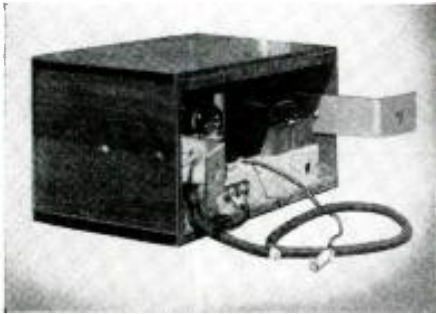

Brackets and antenna switch on tuner's rear.

To receive FM programs, the filaments are turned on and the two toggles thrown to FM. The AM receiver must, of course, be on, as well, as its A.F. section is used.

Little difference in signal strength is found when the antenna is adjusted for the various frequencies on the 88-108-mc FM band.

NBC SYNC CARRIERS

The first use of carrier synchronization for television stations was announced recently by David Sarnoff, chairman of the board of RCA and the National Broadcasting Company. Stations WNBT and WNBW, New York and Washington outlets of the network, both operate on channel 4. In some locations between the two transmitters, viewers get co-channel interference, due largely to the slight difference in frequency of the two carriers. Even though crystal-controlled, this slight difference is inevitable at television frequencies. The beat effect usually destroys reception from both stations. It appears on the screen as horizontal black and white sound bars.

The problem of keeping the frequencies of the two transmitters precisely equal is solved by synchronization. Two sync units are used, one at WNBW in Washington, the other at RCA Laboratories in Princeton, N. J., between New York and Washington.

Receivers set up in Princeton compare the frequencies of WNBT and WNBW. Information about the difference between the two is translated into variations in the frequency of a 1,000-cycle tone, which is transmitted by telephone line from Princeton to New York. The audio frequency variations (± 300 cycles) are used to control WNBT's frequency, keeping it in exact step with that of WNBW.

Though synchronization of television carriers is a recent development, some AM stations have been operated on this basis for many years. Television engineers hope that the new technique will hasten the end of the freeze on TV station allocations; one of the main reasons for the stoppage was that a study had to be made of co-channel interference to determine future allocation policies.

You'll Be Proud to HAVE THIS HANDSOME OHMITE CABINET IN YOUR SHOP!

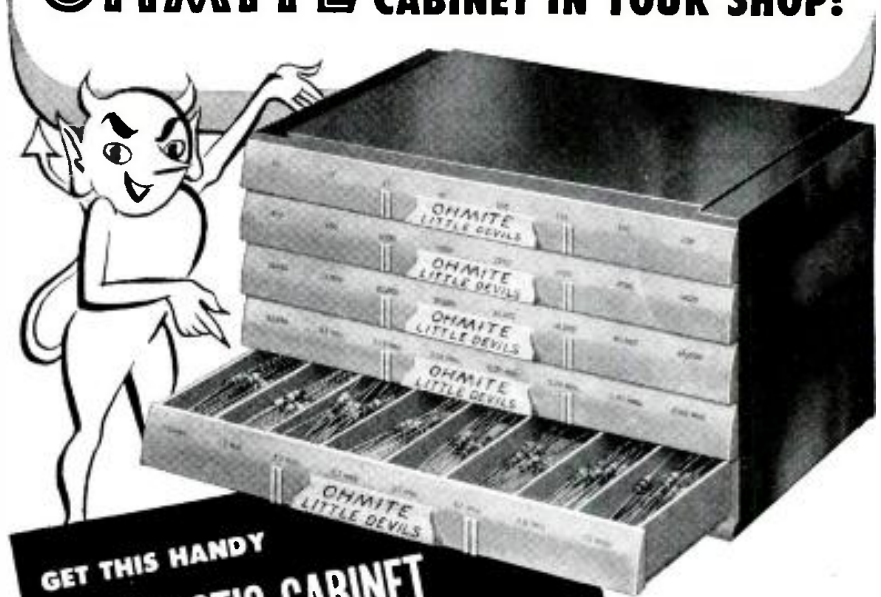

GET THIS HANDY ALL-PLASTIC CABINET
 Packed with 125 "Little Devil" Resistors
—FOR COST OF RESISTORS ALONE!

1/2-WATT ASSORTMENT \$12.50

LITTLE DEVIL COMPOSITION RESISTORS

Guess-work's gone . . . when you use individually marked Ohmite "Little Devils." These tiny but rugged resistors are available in standard RMA values, 1/2, 1, and 2-watt sizes . . . 10 ohms to 22 megohms. Tol. $\pm 10\%$ and $\pm 5\%$. Values to 2.7 ohms available in 1-watt size, $\pm 10\%$ tol.

This lustrous, all-plastic cabinet not only adds a colorful, modern touch to your shop but saves you hours of valuable time by helping you find the resistors you need . . . fast. Factory packed in its five drawers—40 separate compartments—are 125 carefully selected Ohmite "Little Devil" Resistors in the 40 values (10 ohms to 10 megohms, 1/2-watt) most frequently used by servicemen.

Extremely compact—only 9" x 4 3/4" x 5 1/4"—this Ohmite cabinet protects your resistors, and helps you check inventory at a glance. The cabinets are dovetailed top and bottom so they can be stacked one on top of another. Order yours today!

SEE YOUR DISTRIBUTOR



BROWN DEVIL RESISTORS

A favorite with servicemen, these dependable, wire-wound, vitreous-enameled resistors are easily mounted by their tinned wire leads. Tol. $\pm 10\%$. In 5, 10, and 20-watt sizes.

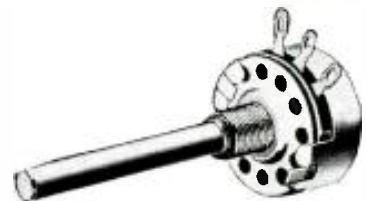

MOLDED COMPOSITION POTENTIOMETER

Built to last, this Type AB Potentiometer has a heat-treated, solid-molded resistance element—not just a film—and provides unusually quiet operation. It has a 2-watt rating.

OHMITE MANUFACTURING CO., 4896 FLOURNOY ST., CHICAGO 44

Be Right with **OHMITE**

RHEOSTATS • RESISTORS • TAP SWITCHES

JUST PUBLISHED!

Complete, practical
data on
**MAGNETIC
RECORDING**



By S. J. Begun
Chief Engineer, The
Brush Development Co.

300 pages, 6x9, 130
illus., \$5.00

Here at last is the "low down" on one of the fastest growing electronic developments in all of its design, engineering and experimental phases. MAGNETIC RECORDING acquaints you with every detail of modern equipment, brings you the latest information on applications ranging from home entertainment to movies, broadcasting, professional and amateur radio and special uses such as military speech scrambling.

**It Pays to Study the
New Developments!**

Acoustic and magnetic factors are carefully explained. A-C and D-C biasing methods, distortion factors, reproducing heads, drive mechanisms and the various recording media and methods of recording, reproducing, and erasing are discussed in detail. Particularly valuable are a complete outline of recording devices and how they are used; a helpful study of instruments for determining recording performance; and a clear discussion of magnetic versus other recording methods. More than 130 diagrams and illustrations make things easily understandable. Use coupon for 10 days' free trial.

All about the theory, types, and makes of recorders, their applications and performance measurement

1. Short History of Magnetic Recording
2. Acoustic Factors
3. Magnetism
4. Theory of Magnetic Recording
5. Components of a Magnetic Recording System
6. Mag-nette Recording Equipment
7. Applications of Magnetic Recording
8. Instrumentation and Magnetic Recording Measurements
9. The Magnetic Phonograph
10. Helpful Glossary of Magnetic Recording Terms

**Cash in on a know how of
FREQUENCY MODULATION**

FUNDAMENTALS—

APPARATUS—

SERVICING

By Nathan Marchand
448 pages, 6x9, over 300
illustrations,
Price \$5.00



FM in high-fidelity reception—in all kinds of mobile communication systems—and now in television—is a must subject for every opportunity-minded serviceman. This book covers it fully—theory and circuits; transmitters, receivers, antennas; testing and servicing. "Will undoubtedly become a bible with every service man."—SERVICE magazine.

It takes more than ordinary radio training to handle FM! This big book shows you how!

10 DAYS' TRIAL

Dept. RE-59, Murray Hill Books, Inc.,
232 Madison Avenue, New York 16, N.Y.

Send me books checked below for 10 days' examination on approval. In 10 days, I will either pay for the books plus a few cents postage or return them postpaid. (Postage paid on cash orders; same return privilege. Books sent on approval in U. S. only.)

- Begun MAGNETIC RECORDING, \$5.00
(Outside U.S. \$5.50 postpaid)
- Marchand FREQUENCY MODULATION,
\$5.00 (Outside U.S. \$5.50 postpaid)

Name.....

Address.....

City, Zone, State.....

European Report

By Major Ralph W. Hallows

RADIO-ELECTRONICS LONDON CORRESPONDENT



HOW loud do you like your radio to be? Most

people, I suppose, would reply something like this: "If I'm listening to a program, I want music to come through loud enough to sound real. Speech from the loudspeaker should have about the same sound level as the voice of a friend talking to me in the room where the radio set is used. But if the radio is just providing a background of which I'm pleasantly conscious though I'm not actively listening, then the volume I want from the loudspeaker is quite low." Fine! But the radio engineers who design our receivers do so first by spoiling vast areas of paper by covering them with figures and mathematical signs. There are no combinations of signs and figures which of themselves indicate "friend talking," or "room where the radio set is," or "loud enough to sound real," or "quite low." What the designing engineer wants before his paper-spoiling activities start are just cold, hard decibels! And, if asked to state his preference in terms of decibels, the ordinary listener might well reply that he couldn't see how the lady who painted her face, fell out of a window, and was eaten by dogs came into the question at all. What had Jezebel to do with radio reception anyway?

The BBC recently set some of its engineers the task of finding out and measuring the various degrees of loudness preferred by several different kinds of people, ranging from transmitting engineers and professional musicians to ordinary listeners of both sexes, all types, and all ages. The results were embodied in a report by two of them, T. Somerville and S. E. Brownless, which contains a good many surprises. The measurements are stated in decibels above a reference level of 10^{-10} watts per square centimeter. From practical experience of their likes and dislikes I expected to find that broadcasting en-

gineers preferred loud reception. They do; on the average they prefer all sorts of programs to come in at a level 13 db above that which best suits the ordinary listener: engineers +88 db, listeners +75 db. Musicians also like more volume than most of us do, but here the difference is smaller—only 80 db against 75 db. What does surprise me is that among ordinary listeners, a very large number of whom were tested, men like more volume than women and advancing years causes a preference for smaller and not greater volume. Taking the mean of the combined measurements for both sexes on symphonic music, light music, and speech, the 15-year-olds like +76 db; the 25-year-olds, +75 db; the 35-year-olds, +74 db; the 45-year-olds, +73.5 db; the 55-year-olds, +73 db; and the 65-year-olds, only +70 db.

"Singing" TV antennas

Though it was unusually mild, the past winter was a very windy one in Britain and many folk who installed TV had considerable annoyance from the loud and incessant singing noise due to the vibration of tubular dipole antennas. Probably some of you in the States have had the same trouble. Here's a remedy recommended by one of our firms specializing in TV antennas, which is very effective, as I can testify personally. It's very simple, like so many good things. All you need to do is pack the tube with sawdust for about 12 inches on either side of the supporting arm. And that is easily done without dismantling the antenna. Remove the plugs at the ends, then push down as much sawdust as is needed. Push down also a wad of rags at each end to keep the sawdust in place. Replace the original plugs and there you are. No antenna so treated can keep you awake at nights by singing and whining as the wind makes it vibrate.

British TV progress

Speaking of TV calls to mind the fact that there are now over 100,000 televisers operating in British homes. That figure may not seem very large to you; but remember that we have still only one transmitting station in action. Recall, too, that less than two years ago the number of owners of TV receivers was not more than 18,500, as I reported in these notes. You'll see that television is going ahead pretty fast here. The reason why there are not more televisers in use is not that people are coy about buying them; it is simply that for several reasons the supply from the manufacturers can't keep pace with the demand from would-be owners. That may seem absurd to you, but it isn't so strange as it looks at first sight. A very

considerable proportion of our radio manufacturers' output consists of radar and radio navigational aids for shipping and for commercial planes (that's one reason why there's a shortage of cathode-ray tubes for televisions), and another big proportion has to be devoted to gear which has been made for export.

There are whispers that a battery-operated receiver is soon to be on the market here. It's still all very hush-hush, and I can't get authentic details; but a little bird tells me that high-efficiency superhet circuits, some novelties in time-base makeup, and the use of a small electrostatic C-R tube enable it to give results with a surprisingly modest number of tubes and no out-of-the-way drain on A- or B-batteries. Well, here's hoping!

Broadcast antennas classified

A useful piece of work has been done lately by our Radio Component Manufacturers' Federation in classifying three types of antenna commonly used for broadcast-band reception and working out a figure of merit for each. They did not find it possible to do anything about outdoor antennas of the T or inverted-L types, since these vary so much in effective height, location, insulation, shielding, and so on. For similar reasons the antenna slung indoors in the attic or fixed round a picture rail doesn't lend itself to classification. But outdoor rod antennas are being used more and more and with them a broad classification, based on the performance to be expected, is possible. The radio dealer can be given figures which enable him to tell a customer with fair certainty which kinds of antennas will and will not give the most satisfactory results.

The drawing shows the three chief types of rod antennas. Those in class A are from 10 to 20 feet in length with their tops not less than 50 feet from the ground; for class B, lengths are usually below 15 feet, and maximum heights 25 feet; the class C antenna is fixed to the window ledge of a ground-floor room and is seldom over 10 feet long or 12½ feet in maximum height. The figure of merit for class A is 1.5; for class B, 0.75; and for class C, 0.075. Assuming that the minimum signal input needed for the broadcast receiver is 1 millivolt, the type of antenna required can be worked out with something like certainty, provided that the field strength of the weakest station to be received is known or can be measured. Multiply the field strength in millivolts per meter by the figure of merit and the answer is the input in millivolts to be expected. So long as this comes to 1 or more the antenna in question will do what is needed. Any of the three types, for instance, is suitable for field strengths over 14 mv; class A or class B will give good reception on field strengths above 1.4 and below 14 mv, though class C will not; below 1.4 mv only class A will do, and it can be relied on for field strength down to about 1400 microvolts per meter.

MAKE MORE PROFIT

Replace Phono Pickup Cartridges



- Makes Cartridges Easier to Sell and Install
- Saves Ordering-Time and Servicing-Time
- Improves Record Playing
- Turns Prospects into Satisfied Customers
- Builds Cartridge and Needle Business



Greatest Merchandising Opportunity in Cartridge History!

YOU CAN MAKE the replacement of phono pickup cartridges a *profitable* side of your servicing. No longer is it necessary to order one cartridge for each repair job. With the 3 basic models in the TORQUE DRIVE KIT, you can immediately replace any one of over 150 types in common use. Furthermore, the revolutionary TORQUE DRIVE Crystal Cartridge modernizes your customer's player, greatly improves reproduction, prolongs record life. Has replaceable Osmium-Tip or Sapphire-Tip needle.

HANDY SALES AND SERVICE KIT

Enables you to make most replacements immediately. Has 6 quick-selling cartridges, 4 extra needles, mounting plates, and replacement guide. Available in Kit "A" (Osmium) and Kit "B" (Sapphire).

Write for Bulletins 141-142, and name of nearest E-V Distributor

ELECTRO-VOICE, INC., BUCHANAN, MICHIGAN
Export: 13 East 40th St., New York 16, U. S. A., Cables: Arlab

E-V Pat. Pend. Licensed under Brush Patents

New Model L14 Microgroove Crystal Cartridge and new Models 20 and 22 Magnetic Cartridge for Regular and Microgroove also available.

IT PAYS TO REPLACE WITH

Electro-Voice

TELEVISION CONVERSION

Without Headaches

- Install the "All-Vue Corrector" Lens in One Simple Operation
- 120 Square Inch Picture From 10-Inch Set
- Obtain Clear Vision From Any Angle
- ELIMINATES EYESTRAIN



Black collar connects the kinescope with the lens. Space between the fluorescent screen and magnifier screen is filled with oil.

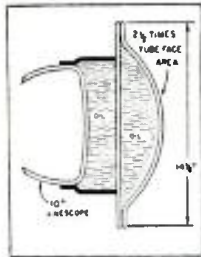

Cross section sketch of the coupling arrangement and oil chambers of the Corrector Lens.



The "All-Vue Corrector" lens being installed in standard set—requiring no electrical changes.



The "All-Vue Corrector" lens completely installed.

Definition is sharper and with better contrasts of blacks and whites. Increases depth. No perception of glare and eye strain due to condenser filtering action. THE PICTURE IS VISIBLE HORIZONTALLY AND VERTICALLY AT ANY ANGLE UP TO 180°.

Sales are fast...profits big...write today for new low prices and complete details.

LIQUID LENS CORP.

77-17 Parsons Blvd., Flushing, L. I., N. Y.

FRENCH RADIO COMPONENTS

THESE three photos, contributed by Mr. E. Aisberg, editor of the French magazine *Toute la Radio*, show the most interesting pieces exhibited at the annual French Parts Show (Exposition de la Pièce Détachée). A striking feature of the show, reports Mr. Aisberg, is the large number of prefabricated tuning assemblies. These pretuned assemblies are used by technicians to construct custom-built receivers, which are much more common in France than in the United States.



These miniature tuning assemblies include all r.f. and oscillator coils for three frequency bands. The main control operates a movable iron core. Matchbox points up the small size.

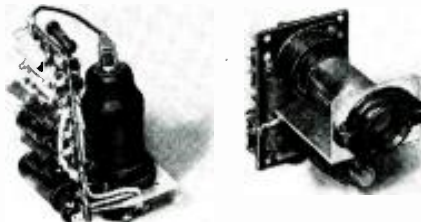

These are assemblies for small test instruments. At the left, a 1000-cycle oscillator for use as a bridge signal source; at the right is an electron-ray balance or null indicator.

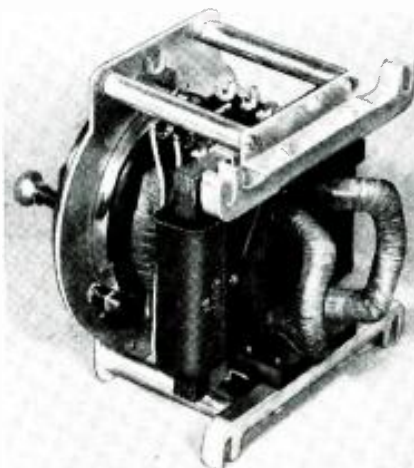

Focus and deflection coils for a CR tube.

Not only are assemblies for receivers sold, but also prefabricated assemblies for test instruments, and even one for a magnetically deflected television tube. Apparently the French radio technician also constructs televisers for himself and others.

The test-instrument assemblies pictured indicate that he may also be inclined to roll his own meters of various types.

PROGRESSIVE

NOW! BUILD 15 RADIOS \$14.75
COMPLETE KIT ONLY...

Absolutely No Knowledge of Radio Necessary. You Need No Additional Parts. The PROGRESSIVE RADIO KIT is the Only Complete Kit. Operates on 110-120 Volts AC/DC

Contains everything you need, instruction book, metal chassis, tubes, condensers, resistors and all other necessary radio parts. The 36-page instruction book written by expert radio instructors and engineers teaches you to build radios in a professional manner. The circuits are designed to provide excellent performance. Altogether, fifteen circuits are constructed, including 11 receivers, 1 audio amplifier and 3 transmitters.

SPECIAL OFFER

Electrical and Radio Tester sent absolutely FREE with each Progressive Radio Kit. Plus FREE Membership in the Progressive Radio Club. Entitles you to free expert advice and consultation service with licensed radio technicians. ORDER YOUR KIT NOW!

BUILD KITS!! SAVE!! LEARN!!

VACUUM TUBE VOLTMETER KIT.....\$23.95
A professional piece of test equipment you need for FM and TV. FREE: Book on Advanced Servicing Techniques.

5" OSCILLOSCOPE KIT.....\$39.95
An absolute "must" for today's radioman. FREE: Book on Cathode Ray Oscilloscope.

VOLT-OHM-MILLIAMMETER KIT.....\$14.95
Simple to construct, inexpensive but accurate. FREE: Book on Elementary Radio Servicing.

SIGNAL TRACER KIT.....\$21.95
An invaluable aid in trouble-shooting. FREE: Book on Radio Test Instruments.

HIGH FIDELITY HUMLESS AMPLIFIER KIT.....\$16.00
Attractive aluminum chassis; complete with five tubes and two selenium rectifiers. FREE: Book on Amplifiers.

ECONOMY AMPLIFIER KIT.....\$5.95
Simple to build; complete with five tubes. FREE: Book on Amplifiers.

7" TELEVISION KIT.....\$59.50
Complete tube kit..... 39.58
FREE: Television Servicing Notes.

10" TELEVISION KIT.....\$99.50
Complete tube kit..... 57.30
FREE: Television Servicing Notes.

10" TELEVISION SUB-ASSEMBLY KIT.\$229.50
Sub assemblies factory-wired; complete with tubes. FREE: Television Servicing Notes.

12" TELEVISION SUB-ASSEMBLY KIT.\$259.50
Sub assemblies factory-wired; complete with tubes. FREE: Television Servicing Notes.

15" TELEVISION SUB-ASSEMBLY KIT.\$349.50
Sub assemblies factory-wired; complete with tubes. FREE: Television Servicing Notes.

5 TUBE AC-DC SUPERHET KIT.....\$14.25
Complete with tubes and cabinet. FREE: Book on Building Receivers.

6 TUBE AC-DC 2-BAND SUPERHET KIT.\$17.45
Complete with tubes and cabinet. FREE: Book on Amateur Radio Building.

7 TUBE AC-DC FM RECEIVER KIT.....\$29.95
Complete with tubes and cabinet. FREE: Television and FM Servicing Notes.

4 TUBE SUPERHET PORTABLE KIT.....\$12.95
Complete with tubes and cabinet; less batteries. FREE: Book on Unusual Radio Circuits.

LP RECORD PLAYER KIT.....\$20.95
Complete with motor, pick-up, permanent needle, amplifier, tubes, speaker, cabinet. FREE: Book on Radio Questions and Answers.

AUTOMATIC

Car Radio Model M-60 (Universal Mounting).....\$27.97
Car Radio Model M-92-C (Built-in Battery Charger) 34.97
Bike Radio (anti-theft feature)..... 17.47
Tom Thum "Buddy" Portable (4-way plug battery charger)..... 27.97
7" Table Model Television Receiver..... 149.85

RMS

All-Channel Video Booster (excellent for fringe areas)..... \$22.75
All-Channel Television and FM Antenna (2 folded dipoles, 2 reflectors)..... 15.00

EICO

V.T.V. M.....\$49.95
5" Oscilloscope..... 69.95
Multimeter..... 17.95

RADIO CRAFTSMAN

FM/AM Tuner Model RC 8.....\$110.00
Amplifier Model RC 2..... 39.00

ESPEY

FM/AM Chassis Model 711 (11 tube receiver).....\$84.00
FM/AM Chassis Model 511 (14 tube receiver)..... 98.00

VM

Long Playing Dual Speed Record Changer Model 400.....\$33.90

FELER

Docket Stethoscope Model TS 3.....\$28.95
Cathode Ray Stethoscope Model TS7 (less phones and probe)..... 69.95
Stethoscope Probe (complete with 6C4 tube)..... 8.25

H.H. SCOTT

Dynamic Noise Suppressor Type 110 A.....\$49.50

FERRIT

FM-TV Sweep Generator (20 MC sweep width).....\$164.95

ALL MERCHANDISE SHIPPED FOB NEW YORK

Deduct 2% if full payment accompanies order. 25% deposit required on C&O orders. Write for further information concerning the above merchandise. Send for our Free catalog.

PROGRESSIVE ELECTRONICS CO.

Dept. RE-25 497 Union Avenue
Brooklyn 11, New York

HAMS! EXPERIMENTERS! LOOK AT THESE TERRIFIC BUYS!

ARMY AIRCRAFT RECEIVER— BC-946-B

Covers 520 Kc to 1500 Kc Broadcast Band. 6 Tubes: 3—12SK7, 1—12SR7, 1—12A6, 1—12K8. Designed for dynamotor operation; can be easily converted to 110 volt or 32 volt use. Two IF Stages. Three-gang tuning con. BRAND NEW, in sealed carton, with tubes and instruction manual, less dynamotor **\$24.50**
Dynamotor DM-2A **\$2.95**

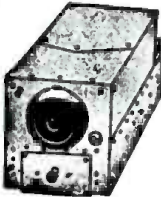

SMASH VALUES IN RADIO RECEIVERS
BC-453—RCVR ..Used \$10.95 New \$17.95
BC-454—RCVR ..Used 6.95 New 8.95
BC-455—RCVR ..Used 7.95 New 8.95
BC-456—MOD ..Used 2.95 New 3.95
BC-457—XMTR ..Used 6.95 New 9.95
BC-458—XMTR ..Used 6.95 New 9.95
BC-459—XMTR ..Used New 19.95

BC-645 XMTR RECEIVER 15 Tubes 435 To 500 MC



The electronic equipment that saved many lives in the war. Set can be modified to use for 2-way communication, voice or code, on following bands: ham band 420-450 mc, citizens radio 460-470 mc, fixed and mobile 450-460 mc, television experimental 470-500 mc. 15 tubes (tubes alone worth more than sale price!): 4—7F7, 4—7H7, 2—7E6, 2—6L6, 2—955 and 1—WE316A. Now covers 460 to 490 mc. Brand new BC-645 with tubes, less power supply in factory carton. Shipping weight 25 lbs. PE-101C DYNAMOTOR for above BC-645 **\$2.95**
UHF ANTENNA ASSY. for above BC-645 **\$2.45**

SETCHEL-CARLSON Beacon Radio Receiver BC-1206-C
Receives A-N beam signals, operates on 24-28 V DC. 5 Tubes: 3—14H7, 14R7, 28D7. Tunes 195 to 420 Kc. Size 4"x4"x6 1/2" wide. 4 lbs. In original carton. BRAND NEW **\$7.95**



BC148 RECEIVER-TRANSMITTER
Built for Sig. Corps by Farnsworth. Range 3960 to 4360 Kc. Complete two-way communications. Operates on batteries or hand generator. CW operation, handkey on base. Entire unit in two hinged parts. (Xmtr & Revr. and Battery compartment) closes down to 15 1/2"x14 1/2"x8 1/2" overall. Less tubes and batteries. Operating instructions included. Used, clean. Each **\$5.95**

UHF ANTENNA AN80-A
Suitable for 400 Mc citizens' band, fine for UHF experimenters. 5 1/4" flat antenna rod, mounted on porcelain base, with mounting plate and right angle feed through. Brand new. Special at **\$0.69**

BIAS METER BRAND NEW!
Excellent for measuring DC voltages, bias voltages, or checking polarity of DC voltages. Designed originally for telephone and tele-type voltage measurements. With adaptor plug, schematic, metal carrying case. Batteries not needed for operation. Your cost, only. **\$5.95**

GE THYRATRON FG-105

Brand New
MERCURY RECTIFIER
Individually boxed in factory sealed cartons. List Price \$40 your cost

\$11.95 While They Last!
each

For continuous rectifier and welder control service. Tet-rode type, indirectly heated cathode; 10000 V peak, 10000 V peak inverse, Av. Max. current 6.4 amps continuous. 2.4 to 4 amps welder control service.

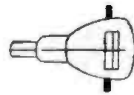

SPECIAL!
SPERT! R-F Vacuum Switch
Fanned Collins Xmtr Antenna Switch. 9200 peak volts, 8 amperes. BRAND NEW!
Only **\$1.69**

OTHER TUBE VALUES

Lots of 4 Each
1625 35¢ 864 25¢ 6K7 39¢
1626 35¢ 1K60 60¢ 12SQ7 39¢
12J5GT 31¢

DC AMMETER 0-15 Amps

A terrific buy! 3 1/4" easy reading scale. 75 divisions. Black plastic case 4 1/4"x5 1/4"x2 1/4". Rubber covered test clip leads plus black metal carrying case with hinged cover. Brand New. Wonderful for automotive, battery charging, general test work. Value \$25. All yours for only **\$3.99**



McElroy Automatic KEYS

For Xmtr keying or code practice. Has photocell and sensitive relay. Variable speed motor, 110V AC or DC. Complete with 2-117Z6 and 1-117L7 tubes, your cost **\$14.95**



CARBON HANDMIKE
Genuine Sig. Corps Mike, 200 ohm, single button, has press-to-talk switch, 4-ft. rubber cable, amphenol plug. Beautiful satin chrome finish. BRAND NEW **\$2.25**

SELSYN 2J1G1
Operates from 57 1/2 V 400 cycles. Suggested wiring for 110 V 60 cycle included. Used, tested. Price per pair **\$3.50**



ARMY FIELD TELEPHONES

Type EEB—Talk as far as 17 miles. Dependable 2-way communication at low cost. Ideal for home, farm, field. Up to six phones can be used on one line. Each phone complete with ringer. Originally cost govt. \$39.90 each. Used, good condition **\$9.95** each



QUANTITY PRICES

Inquiries welcomed from institutions, wholesalers, dealers, large users. Phone, write, wire for quantity prices.
Please include 25% Deposit with order—Balance C.O.D. MINIMUM ORDER \$3.00. All Shipments F.O.B. Our Warehouse N.Y.C.

G & G BERRIDE MAJESTIC
RADIO PARTS SERVICE
53 VESEY STREET · NEW YORK 7, N.Y.

TERRIFIC VALUE 24-VOLT STORAGE BATTERY, BRAND NEW 17 AMP. HRS.

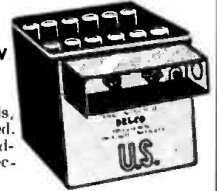

Made by Delco. 12 cells, heavy duty, very rugged. Shipped dry, uses standard sulphuric acid electrolyte.

VERY SPECIAL **\$17.95**



WILLARD 2-VOLT STORAGE BATTERY 20 Ampere-Hours

Exact replacement for GE portables—brand new. Each **\$1.95**

GOULD 6-VOLT STORAGE BATTERY

Navy Standard, Black Rubber Case. BRAND NEW. 15 Amp. Hour Rating **\$4.95**

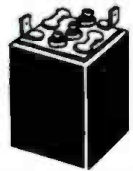

WILLARD 6-VOLT STORAGE BATTERY

Similar to above but in transparent plastic case. Real value at **\$4.95**

1-QUART BOTTLE BATTERY ELECTROLYTE
Made by Willard, for above storage batteries, 1 qt. sufficient for two 2-volt cells. Hermetically sealed. SPECIAL. per qt. bottle **\$1.25**

7-PRONG 2-VOLT RADIO VIBRATOR for Portable and Farm Sets Replacement for GE LB 530 **\$1.65**

LOOK AT THESE PM SPEAKER BUYS!

Alnico V, 4" PM, less trans. **\$1.30**
Alnico V, 5" PM, less trans. **1.45**
Alnico V, 6" PM, less trans. **1.79**
Alnico V, 8" PM, less trans. **2.75**
Alnico V, 10" PM, less trans. **4.50**
Alnico V, 12" PM, less trans. **4.95**
Alnico V, 6" PM, with trans. **2.35**
Alnico V, 8" PM, with trans. **3.25**
Alnico V, 10" PM, with trans. **4.65**
6V6—Midget Output Trans. **.42c**
50L6—Midget Output Trans. **.42c**
ACDC—Chokes **.32c**

Wonderful Condenser Buys!

Oil-Filled Metal Cased Condensers
All Brand New—Perfect—Standard Makes
.1 mf 400V 14¢ 4.0 mf 600V 79¢
.5 mf 600V 17¢ 3-3 mf 600V 88¢
2.0 mf 600V 34¢ 25 mf 600V \$1.79
1.0 mf 1000V 49¢ 8 mf 1000V 2.25
1.0 mf 1500V 69¢

FP TYPE FILTER CONDENSERS Standard Makes—Brand New

30 mfd 50 V 12c
100 mfd 50 V 17c
40/40/20 mfd 150/150/20 V 35c
8 mfd 500 V 38c
16 mfd 500 V 49c
8x8 mfd 500 V 59c
20/20 mfd 450/25 V 59c
30 mfd 350 V 55c

TUBULAR 50 + 30 Mfd 150V NEW

lots of 12, 19c ea.
20 Mfd 200 V INVERTED CAN SCREW MT 29c
4/3 Mfd 400/475 V Round Metal Can Com neg 39c
60 Mfd 110 V 60 cy. AC motor start Cond. round metal can 99c

FREQUENCY METER CABINET

For BC-221 Series freq. meters. BRAND NEW! 3 compartments. Massively built. 14 1/2"x10 1/2"x10". Value \$20.00. Complete with canvas cover for both ends. Yours for only **\$3.95**

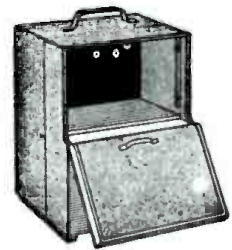

GREEN STOCKS COMPLETE LINE EICO INSTRUMENT KITS

HIGH PRECISION VACUUM TUBE VOLTMETER



Model 221K Complete Kit **\$23.95**

THE MOST USEFUL TOOL ON YOUR RADIO BENCH! D.C. and A.C. ranges 0-5, 10, 100, 500, and 1000 volts. Ohmmeter ranges from .2 ohm to 1,000 megohms in steps of 1x1, 1x10, 1x100, 1x10,000 and 1x1 megohm. Db scale from -20 to 55 Db in 5 ranges. D.C. input resistance is 25 megohms. A.C. input impedance is over 1 1/2 megohms. Diode A.C. rectifier for greater accuracy and wider frequency range to 30 Kc. Large, rugged, 4 1/2" meter with all A.C. and D.C. readings on one simple scale. All multiplier resistors matched to 1% accuracy. Complete with 6BE6, 6X5, 6SN7 tubes and test prods. All numbers etched into panel; can never rub off. Heavy gauge steel cabinet. Size: 9-7/16" x 6" x 5". Shipping Wt. 10 lbs. **NOTHING ELSE TO BUY!**

Model P-75 germanium crystal probe for visual RF signal tracing, and measurements to over 200 megacycles **\$7.50**

ASSEMBLED VTVM

Model 221—Includes all advantages of above. Completely assembled, hand calibrated and tested and ready to use, at the amazingly low price of..... **\$49.95**

POCKET VOLT-OHM-MILLIAMMETER COMPLETE KIT



Model 511-K A MUST FOR EVERY SERVICE MAN! The small, handy instrument

that every repairman uses a thousand times a day. Large 3" meter, beautiful etched panel. Simple to assemble. A PERFECT KIT FOR BEGINNERS. Ranges: DC—0/5/50/250/500/2500 volts. AC—0/10/100/500/1000 volts. Output—0/10/100/500/1000 volts. 100 Ma. 0/1/10. DC Amps—0/1/10. Ohmmeter—0/500/100,000 ohms/0/1 meg. Ohm meter—R to 55 Db **\$14.95**

ASSEMBLED—READY TO USE

Model 511—completely wired, tested and assembled at the factory. Rugged, built for heavy duty **\$17.95**

OSCILLOSCOPE KIT



Model 400 K Indispensable for AM, FM, and TELEVISION. Horizontal sweep circuit 15 to 30,000 cycles. All controls on front panel. Linear sweep with 8N4 gas triode. Graph screen for measuring peak to peak voltage. Frequency response of horizontal and vertical amplifiers from 50 cycles to 50 Kc. Input impedance 1 megohm and 50 mufd. Etched panel for long life. Tube complement—5-6S7, 2 5Y3, 1-884, 1-5HP1. Provision for external synchronization, test voltage and intensity modulation. Deflection sensitivity, 30 volts per inch full gain. Detailed instructions and pictorial diagrams included. **NOTHING ELSE TO BUY!** Size: 8 1/2" W x 13" H x 17" D. Ship wt 30 lbs **\$39.95**

COMPLETELY FACTORY WIRE OSCILLOSCOPE

Model 400—Same as above but wired, tested and assembled. A sturdy well-designed instrument ready to use on your work bench. Don't wait. **\$69.95** order NOW!

SENSATIONAL PRICE REDUCTION!

Model 113-A MULTI-ANALYST—Completely wired, ready to operate. **NOW FOR THE FIRST TIME..... \$69.95**

A Complete VTVM that follows signal from antenna to speaker! Extremely sensitive wide range A/DIHF signal tracer. 6 tubes—gain over 90 in probe alone! Limited quantity—order NOW!

20% Deposit required with C. O. D. Orders. All orders F.O.B. New York. All orders must include shipping charges.

THE FAMED HOUSE OF BARGAINS

GREEN RADIO DISTRIBUTORS

Electronic Supplies and Equipment
482 Sutter Avenue, D1 2-4444, Brooklyn 7, N. Y.

SUBMINIATURE-TUBE RECEIVER

? Please give me a diagram for a small receiver using subminiature tubes. —H.J.W., Sea Cliff, N. Y.

A. The receiver shown in the diagram uses four subminiature tubes operating with a 22.5-volt B-battery. The converter is a 2G22, the i.f. amplifier is a 2E32, and the 2E42 is used as second

detector and first audio. The 2E36 output amplifier plate circuit uses an audio choke (almost any value will do) as a load so that d.c. can be kept off the phones. This will be useful if crystal phones are used. Because the 2E32 is a sharp-cutoff tube, the a.v.c. will not be as effective as in some receivers, but it will be of some help.

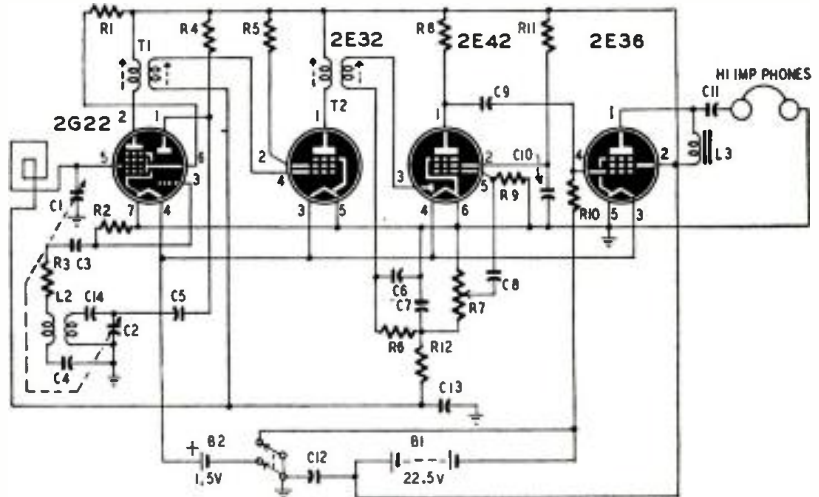

- R1, R5—15,000 ohms, 1/2 watt
- R2, R6—47,000 ohms, 1/2 watt
- R3—100 ohms, 1/2 watt
- R4—27,000 ohms, 1/2 watt
- R7—1-megohm potentiometer
- R8—1 megohm, 1/2 watt
- R9—10 megohms, 1/2 watt
- R10—5 megohms, 1/2 watt
- C1, C2—365-μmf, 2-gang tuning capacitor
- C3, C6—100-μmf mica
- C4, C10, C13—.03-μf, 150-volt paper
- C5—.001-μf, 150-volt paper

- C7—50-μmf mica
- C8, C9—.01-μf, 150-volt paper
- C11—0.1-μf, 150-volt paper
- C12—10-μf, 50-volt electrolytic
- C14—250-μmf mica
- L1—broadcast loop antenna
- L2—broadcast oscillator coil
- L3—audio choke
- T1, T2—456-kc i.f. transformers
- B1—22.5-volt battery
- B2—1.5-volt battery
- SW—d.p.s.t. toggle switch

T. R. F. SET WITH ACORN TUBES

? Please show a design for a t.r.f. broadcast-band receiver using five miniature tubes. —C.F.M., Brooklyn, N. Y.

A. The complete circuit is given in the

schematic. The antenna and r.f. coils are standard commercial broadcast units. Low-priced surplus acorn tubes are used in r.f. and detector stages.

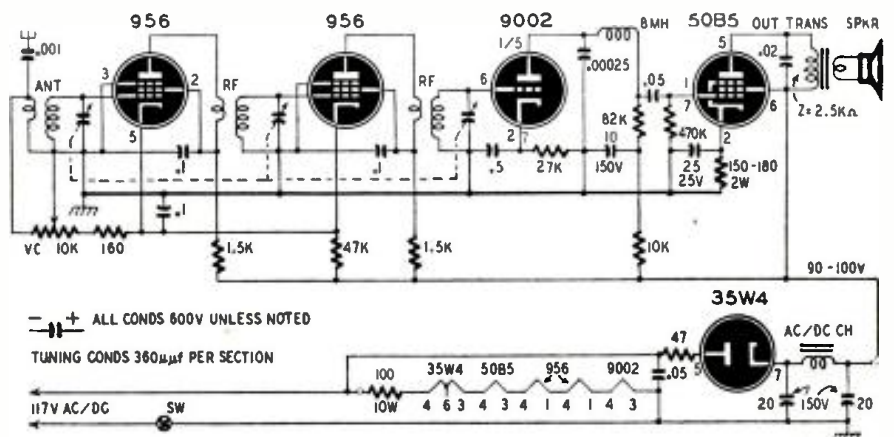

FIXED-TUNED CONVERTERS

? Please print a circuit of a fixed-tuned converter for use with my standard automobile receiver. I want to cover the 4.5- to 5.5-mc and 8.5- to 10.5-mc bands by using the tuning control on the receiver. —E.A., East London, South Africa.

input circuit that covers a given band of frequencies. The oscillator signals beat with signals in the passband of the input circuit to produce heterodyne or beat notes within the tuning range of the receiver. It is very difficult to design a suitable bandpass circuit to operate over the bands you want to cover. Furthermore, the beats between the desired signal and the fixed oscillator

A. Fixed-tuned converters usually have a stable oscillator and a bandpass

must fall within the tuning range of the receiver. A 3.9-mc fixed oscillator will produce 600- and 1,600-kc heterodynes when mixed with 4.5- and 5.5-mc signals, respectively. These signals are within the broadcast band so they can be received on a broadcast set. The weak point in this setup is the bandpass circuit, which must be 1 megacycle wide.

A 7.9-mc fixed oscillator will beat against an 8.5-mc signal and produce a 600-kc heterodyne, and against a 9.5-mc signal to produce a 1,600-kc heterodyne. The receiver would have to tune from 600 to 2,500 kc to cover the 8.5- to 10.5-mc band with a fixed tuned converter.

I suggest you use a tuned converter and use the receiver as an i.f. stage. The circuit shown on page 36 of the April, 1948, issue of RADIO-CRAFT can be modified to meet your needs. The transformer in the plate circuit of the 6K8 should be tuned to 600 kc or some quiet spot on the low-frequency end of the broadcast band. The oscillator padders and trimmers should be adjusted so the oscillator and antenna circuits track over the tuning range. Narrow segments of any band can be covered with a bandspread control consisting of ganged 35- or 50- μ f capacitors connected across the main tuning capacitors.

RHOMBIC FOR LOW-BAND TV

? Please outline a horizontal rhombic antenna suitable for receiving TV stations on channels 3 and 5. This is to be used with a receiver with 300-ohm antenna input terminals.—J.W., Randolph, Wis.

A. The sketch shows a rhombic suitable for any low-band station. This antenna should be terminated with two 390-ohm 2-watt metallized resistors. A matching section composed of two 34-inch lengths of No. 12 wire spaced 4 inches apart and two 34-inch lengths of 3/16-inch tubing spaced 2 inches apart. The sections are connected with 2 inches of No. 12 wire. The tubing connects to standard 300-ohm line.

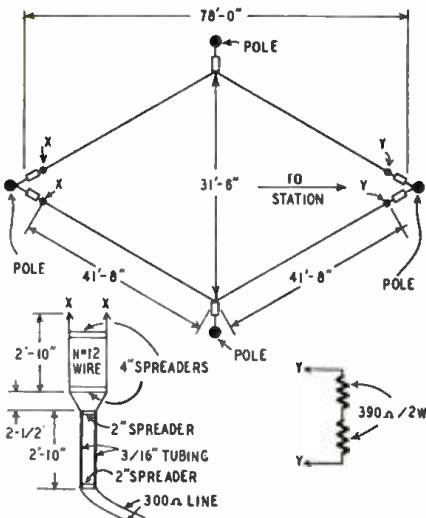

United Cuts Prices!!!

- **POWER TRANSFORMERS**, Standard Brand.

Type	H.V.	Ma. Fil. #1	Fil. #2	Price
P-011	700ct.	70 5v.3a	6.3v.2.5a	\$2.19
P-012	700ct.	90 5v.3a	6.3v.3.5a	2.85
P-013	700ct.	120 5v.3a	6.3v.4.3a	3.19
P-014	750ct.	150 5v.3a	6.3v.5a	4.19
- **VIBRATOR TRANSFORMER**—To fit current models of Motorola auto sets. New—\$1.95.
- **TELEPHONE REPEATER COIL—C-161**, 1 to 1 ratio. One side center-tapped for feeding keying lines into telephone circuits. Completely shielded. Shpg. Wt. 3 1/2 Lbs. New—\$1.49.
- **RELAYS**—Stepper, type H-706, 4 circuits 25 positions, continuous. Position Indicator on drum. D.C. Coil resistance 12 Ohms. Like new condition —\$4.75; **TELEPHONE LEVER TYPES**, #861 S.P.D.T. Coils—200—500 Ohms; #862 S.P.D.T. Coil 500 Ohms; #863 D.P.S.T. & S.P.D.T. Coil 500 Ohms; #864 D.P.D.T. & D.P.S.T. Coil 500 Ohms; #865 S.P.D.T. & D.P.S.T. Coils 200 + 500 Ohms; #866 D.P.D.T. & 5 P.S.T. Coils 200 + 200 Ohms; #867 D.P.D.T. Coil 500 Ohms; #868-1 3 P.S.T. Coil 500 Ohms; #868-2 D.P.S.T. Coil 500 Ohms; #870 S.P.S.T. Norm. closed coil 500 Ohms. All like new. Price \$1.29; Time lag types; #869-1 S.P.D.T. Coil 500 Ohms—\$1.59; #869-2 S.P.D.T. and D.P.S.T. Coil 500 Ohms—\$1.75.
- **CRYSTAL KIT FOR BC-604 WESTERN ELECTRIC FM TRANSMITTER**—80 crystals in metal cabinet. Covers all frequencies from 20 Mc. to 27.9 Mc. in 100 Kc. steps. Shpg. Wt.—7 Lbs. New—\$12.50.
- **423 MODULATOR UNIT**—A precision R.F. Osc., tunable with a National retret-vernier dial, between 185 and 205 Mc. audio Osc. semi-variable, with 2 stages audio Amp. 115 V. 60 Cyc. power supply. All high quality parts. Heavy duty construction. Complete with 1-955, 2-637, 1-6F6 and 1-5W4 tubes and dipole ant. Shpg. Wt.—45 Lbs. New. Only \$12.50.
- **AZIMUTH CONTROL HEAD**—Bendix MN-52. Dial calibrated in 360 degrees. Brand new in cartons. Shpg. Wt.—1 1/2 Lbs. Each—\$1.79.
- **AIRCRAFT HOMING RECEIVER, ZB-1 OR SIMILAR UNITS**. A T.H.F. Receiver unit covering 231 to 258 Mc. Beautifully built and calibrated. Uses 4-954 tubes. Complete with Relay and Test Osc. Shpg. Wt. Approx.—16 Lbs. New—\$14.95.
- **TG-10 PHOTO ELECTRIC KEYS**—Used by Army for code practice. A high gain 25 watt heavy duty amplifier with photo cell input. May be converted to PA or Phono amplifier. Uses 2-68J7, 2-68N7, 2-6L6, 1-5U4G and 1-423 tubes. Less tubes, tapes and reels. Shpg. Wt. Approx.—110 Lbs. Good condition. Size: 21" x 15" x 12". Only—\$17.50.
- **CONTROL CABLES**—MC-124, for compass receivers, 20 ft. long. With splices and ferrules. New—\$2.39; MC-215, for 274-N series receivers, etc. 15 ft. long. Small splices and ferrules. New—\$1.69; Loop Cable for MN-20, etc. 6 ft. long with 6 contact plug at both ends. Shielded with aluminum braided BX. New—\$1.69.
- **DM 21-B DYNAMOTOR**—14 V. Input, 235 V. @ 90 Ma. output. Completely shielded with filters. Shpg. Wt.—5 Lbs. Brand new. Only—\$24.49.
- **MODEL DM-32-A DYNAMOTOR**—Input: 28V. @ 1.1 A. Output: 250 V. @ 60 Ma. For 274 N. Series Receivrs. With mounting. SHPG. Wt. Approx.—3 Lbs. New—\$1.59.
- **DM-33 DYNAMOTOR**—Input: 28V. Output: 540 V. @ 250 Ma. Int. SHPG. Wt.—10 1/2 Lbs. New. In original cartons. Only—\$22.69. each.
- **DM-34 DYNAMOTOR**—Input: 12V. @ 2.8 Amps. Output: 220 V. @ 80 Ma. With filters and plug. Shpg. Wt.—3 Lbs. Good condition. used—\$1.59. Brand New—\$2.19.
- **DM-35 (12V) AND DM-37 (24V) DYNAMOTOR**—Input: 62.5V. @ 225 Ma. Slightly used. Very good condition. Shpg. Wt.—12 Lbs. Each—\$1.95.
- **MODEL DM-36-D (W.E.) DYNAMOTOR**—Input: 28V. @ 1.4 A. Output: 220 V. @ 80 Ma. with filter. Used. In good condition. Shpg. Wt.—7 Lbs. Only—\$1.29.
- **NAVY TYPE DYNAMOTORS**. High efficiency P.M. field units. May be used on 6 V.D.C. with 1/2 output voltage ratings. **MODEL REC #516**—Output: 275 V. @ 110 Ma. Input: 12 to 24 V.D.C. SHPG. Wt. 10 1/2 Lbs. Selling for—\$2.50; **MODEL #515 TRANS.**—Output: 500 V. @ 50 Ma. SHPG. Wt. 10 1/2 Lbs. Selling for—\$3.50. The above are new in cartons.
- **CONDENSERS**—1 + 1 Mfd. 115 Vac.—29c; 3 Mfd. 330 Vac.—49c; 1 Mfd. 1000 V.D.C. Oil. 6 for \$1.00; 2 Mfd. 600 V.D.C. Oil. 6 for \$1.00; 4 Mfd. 800 V.D.C. Paper. 3 for \$1.00; 1 Mfd. 2000 V.D.C. Oil 3 for \$1.00; 3 Mfd. 2000 V.D.C. Oil. 2 for \$3.45; 3 Mfd. 2500 V.D.C. Oil. Each—\$2.49; 8 Mfd. 2500 V.D.C. Oil. Each—\$8.50; 2 Mfd. 5000 V.D.C. Oil. Each—\$9.50; Filter Strips—(2) 8 Mfd. P.R.S. type 450 V.D.C. condensers. (1) 6000 Ohm 20 W. resistor and a few ceramics all mounted on a small bakelite strip. New. 3 strips for \$1.00.
- **METERS**—A.C. Voltmeter, (0-150) 3" round. (I.E. scale slightly clouded) New—\$3.00; D.C. Ammeter, (0-50 on scale, 50 mv. movement) 2" round. (I.E. Less shunt. New—\$1.95; D.C. Voltmeter, (0-500) 3" round Bakelite case Sun Mfg. 1000 o/p/v. New—\$2.75; Output Meter, 0-10. Weston #507 2" round Bakelite case mounted in portable wooden case. New—\$2.39; Blas Meter, (1-97-A) Zero center Marlon 3" round meter mounted in a sturdy steel case, 5" x 4 1/2" x 7". Reads: 115 V.D.C. or 100 Ma. D.C. each side of

- center. Diagram included. Shpg. Wt.—7 Lbs. New—\$4.95.
- **METER ACCESSORIES**—Ammeter shunt, Weston type D-41207, 100 Amps. R.C. 50 Mfd. Aloud on Bakelite base. Shpg. Wt. Approx.—1 Lb. Brand new—\$2.95; Current Transformer, Weston type 880. Ratio 75:1. 50-133 cycles. With mounting bracket. Shpg. Wt. Approx.—1 Lb. New—\$2.75.
- **SWITCHES**, **BEAM MOTOR SWITCH**—D.P.D.T. momentary. Shpg. Wt.—6 Oz. New—39c; **MICRO SWITCH**—Normally closed, 10 Amps. 125 V. Pin operated. Shpg. Wt.—6 Oz. New—45c; **MOTOR SWITCH**—3 P.D.T. 3 buttons labeled "Manual—Off—Automatic." Locks in both operating positions. Ideal for shop equipment operation. Shpg. Wt.—9 Oz. New—39c; **ANTI-CAPACITY LEVER SWITCH**—(Mossman) Heavy duty contacts. (Center position: 3 poles closed; 1st position: 4th pole closed (Momentary). 2nd position: all poles open. Phosphor bronze leaves. Spring loaded lever. Positive action. Size: 1 1/4" x 1 3/4" x 6". Shpg. Wt.—1 Lb. New—98c.
- **VOLUME CONTROL ASSEMBLY**—500,000 Ohms. S.P.S.T. C.L. switch. 5/8" Dia. Brass shaft. 1/8" dia. slotted and knurled end. 2 leads. one 1 M. at 400 V. and one .005 Mf. 400 V. condensers are attached Shpg. Wt.—6 Oz. New—50c.
- **POTENTIOMETERS**—5000 Ohm—I.R.C. type D11-114 Silent Spiral. In original cartons, with hardware and universal shaft. SHPG. Wt.—6 Oz. Only \$1.45; 1 Megohm—Midret C.T.S. short knob and panel plate. Shpg. Wt.—6 Oz. 25c; 10,000 Ohm—Midret C.T.S. 5/16" shaft. Shielded. Shpg. Wt.—6 Oz. 25c; Dual Wire-wound—10,000 Ohms each section. Separate screwdriver adjustments. 2 Watt. Shpg. Wt.—6 Oz. New—65c; Dual H.D. Ohmite—1200 Ohms at 35 Amps. and 3 Ohms at 4.7 Amps. Baked enamel elements. Complete knob and panel plate. Shpg. Wt.—1 Lb. New—85c; Single wire-wound—100,000 or 70,000 Ohms 2 Watt. Bakelite case—1 3/4" Dia. 7/8" deep. Long Shaft. Shpg. Wt.—8 Oz. New—65c; 4 Gang Wire-wound—(Tarasat) Heavy duty bakelite construction with metal supports, 6,000, 2,500, 30,000 and 30,000 Ohms. Size: 1 3/4" x 2 1/2" x 2 1/2" long. shaft. In original cartons. Shpg. Wt.—1 Lb. 75c; Toroidal Potentiometers—Precision unit completely enclosed in heavy aluminum casing. 500 Ohms Wire-wound. W.E. or G.E. New—\$1.19; **RHEDSTATS**—Ohmite baked enamel wirewound. Air-cooled and shielded. Aircraft type. 30 Ohms at 1.35 Amps. Shpg. Wt.—2 Lbs. New—\$1.75.
- **PATCH CORDS**—Red fabric covered cable contains 2 rubber covered tinsel conductors. Complete with 2-PL-47 plugs on ends. 21" L. and 34" L. Shpg. Wt.—2 Lbs. Either type. New. 3 for \$1.00.
- **RECORDING HEADS**—(Shure) Magnetic. 4 Ohms at 400 cycle. With cord and stylus screw. Slightly scratched. Good condition. Shpg. Wt.—2 Lbs. Only 79c.
- **HEAVY CABLE 14 CONDUCTOR WEATHER PROOF**—14 conductors, rubber and fabric covered. #14 stranded and tinned. Enclosed in heavy outer rubber jacket. Heavy brass 14 contact plugs on either end. Cable is 1" O.D. SHPG. Wt.—110 Lbs. New. 100 foot coils—\$7.75.
- **NEON BULBS**—G.E. type NE-48 1/4 W. Auto base. 10 for \$1.75.
- **SCR-522 POWER PLUG AND CABLE**—Housed in aluminum BX. 3 1/2" long 12 conductors. Shpg. Wt.—2 Lbs. New—\$1.00.
- **PL-68 PLUGS**—3 contact microphone type. 10 for 95c; **TELEPHONE JACKS**—To fit PL-68 plug. Panel mounting type. 10 for 98c.
- **CIRCUIT BREAKERS**—G.E. type AF-1 230 V. 4 1/2" x 5" Ambs. Single circuit. Overall size: 3" x 4 1/2" x 6". Shpg. Wt.—1 1/2 Lbs. New—\$1.85; Sq.D. Type M. 120-240 V.A.C. 20 Amps. 2 poles. Overall size: 2" x 3" x 4 1/2". SHPG. Wt.—2 Lbs. New—\$1.75.
- **FABRIC LOOM**—Weather-proof. Ideal for sleeving on T.V. and FM antenna lead-ins, thru sky lights and around corners. I.D. 3/4" x 3/4". 7/8". (Specify size: 50 feet, any size—\$1.45.
- **THROAT MIKES**—T-30 (Shure) New in cartons—50c.
- **KITS**—Ceramic insulators—assorted popular types. New and usable. Shpg. Wt.—4 Lbs. 15 for 59c; Bathub condensers—multiple and single units in assorted voltages and capacities. Shpg. Wt.—3 Lbs. 15 for 78c; Carbon resistors—assorted sizes. All new. Mostly insulated. 100 for \$1.95; Mica condensers—assorted capacities and voltages in silver and ruby mica. 100 for \$2.95; Ceramicons—1.0 Mmf. to 1000 Mmf. in assorted voltages. 100 for \$2.95; Filter condensers—all new and usable. 10 for 95c; Hardware—standard nuts, bolts, washers, etc. 3 Lbs. for \$1.29; Tube sockets—all types and sizes. New. 20 for 95c; Coil forms. Various types and sizes. 15 for 45c.

Write for free copy of UNITED SURPLUS new catalog!

★ BY POPULAR DEMAND!!

UNITED SURPLUS'S Surprise "Package"...\$1.29
More than 10 Lbs. of assorted electronic units and parts.

Quantities are limited—order now! Prices subject to change without notice. Minimum order—\$2.00. 25% deposit required. Balance C.O.D. All orders shipped F.O.B. Chicago.

UNITED SURPLUS MATERIALS
314 S. Halsted St. Chicago 6, Ill.

AN AUTOMATIC BUG

The electronic keyer described in the magazine *Break-In* (New Zealand) is simple and easy to build and operate. The schematic and construction details for the key are shown. After constructing the unit and key, adjust R1 and R2 so their full resistance is in the circuit. Apply power. V1 should be cut off and the relay open. Throw the key to DOT position. The voltage should be equal on the plates of V1 and V2. If it is not, substitute other 0.1- μ f capacitors for C1 and C2 and other 100,000-ohm resistors for R4 and R5 until the plate voltages are

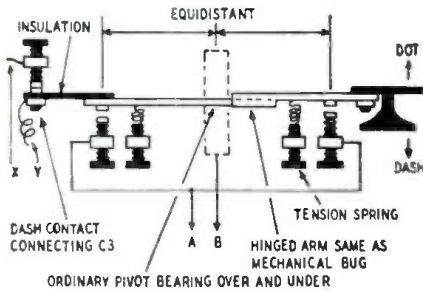

equal while making dots. When this is done, the length of the dots and the spacing between them will be correct for standard sending.

Move the key to DASH. This places C3 in parallel with C2 and causes the relay to stay closed for three times the length of one dot. Check this by measuring plate voltages. One section should drop by one-third and the other increase by one-third the resting plate voltage. Adjust the value of C3 until this condition is met.

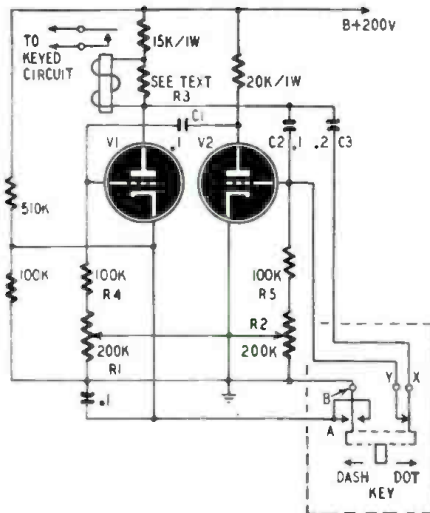

Speed is increased by decreasing the values of resistors R1 and R2 simultaneously.

The keyed circuit is controlled by a sensitive relay with normally-open contacts. R3 should have a resistance about ten times the resistance of the relay coil. V1 and V2 may be any receiving-type twin-triode with separate cathodes or two separate triodes.

The key can be made in any convenient form. It can be built around a discarded "bug." Contacts common to A-B should be open and the X-Y contacts closed when the arm of the key is in the normal position.

MAY, 1949

EVERY SERVICEMAN CAN afford SUPERIOR TEST EQUIPMENT

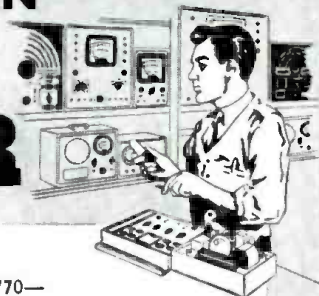

THE NEW MODEL 770— An Accurate Pocket-Size VOLT-OHM MILLIAMMETER (SENSITIVITY: 1000 OHMS PER VOLT)

- Features:
- Compact-measures 3 1/2" x 5 3/4" x 2 1/4"
 - Uses latest design 2% accurate 1 Mil. D'Arsonval type meter.
 - Same zero adjustment holds for both resistance ranges. It is not necessary to readjust when switching from one resistance range to another. This is an important time-saving feature never before included in a V.O.M. in this price range.
 - Housed in round-cornered, molded case.
 - Beautiful black etched panel. Depressed letters filled with permanent white. Insures long-life even with constant use.
- Specifications: 6 A.C. VOLTAGE RANGES: 0-15/30/150/300/1500/3000 volts.
 6 D.C. VOLTAGE RANGES: 0-7 1/2/15/75/150/750/1500 volts.
 4 D.C. CURRENT RANGES: 0-1 1/2/15/150 Ma. 0-1 1/2 Amps.
 2 RESISTANCE RANGES: D-500 ohms. 0-1 Megohm.
- The Model 770 comes complete with self-contained batteries, test leads and all operating instructions. **\$13.90 NET**

MFD. BY



SUPERIOR INSTRUMENTS CO.

227 Fulton St., New York 7, N. Y.

at your regular jobber

WHIP ANTENNA FOR MOBILE AND STATIONARY USE

MP-48 Mast Base Mounting with heavy vertical coil spring. Insulated at top to receive Mast Section MS-53. Mast Base only... \$2.95

MAST SECTIONS: For above MP-48. Tubular steel, copper coated, painted. In 3 foot sections. Bottom section MS-53 can be used to make any length. MS-52-51-50-49 for taper. Screw-in type. Any Section—Price... .50 each

TRANSFORMERS—110 Volt 60 Cycle Primaries:

Sec. 24 Volt 2 amp.	\$2.25
Sec. 14-14 or 28 Volt 7 1/2 or 15 amp.	4.95
Sec. 12 Volt 1 amp.	1.50
Sec. 24 Volt 1 amp.	1.95
Sec. 24 Volt 5 amp.	1.50
Sec. 36 V.A.C. 2.5 amp.	2.95
500 Vt-T—60 MA 6.3 V. 5 amp., 5 V. 3 amp.	2.45
=RE-60	
700 Vt-T—90 MA 6.3 V. 4 amp., 5 V. 3 amp.	2.95
=RE-90	
800 Vt-T—200 MA 6.3 V. 6 amp., 5 V. 3 amp.	4.75
=RE-200	

115 V.A.C. 60 Cycle Input TRANSFORMERS: Output: 750-0-750 V.A.C. (600 V. P.P.) after choke input filter at 250 MA. Includes 6.3 V.A.C. winding at 5 amps. 5.0 V.A.C. winding at 4 amps. #11-100... \$7.95

Output: 600-0-600 V.A.C. at 250 MA. 12 V.A.C. at 3 amps; 12 V.A.C. at 3 amps & 5 V.A.C. at 3 amps. Designed for Army surplus Transmitters. #11-108 \$6.90

Output: 250-0-250 V.A.C. at 60 MA. 24 V.A.C. at 6 amps; 6.3 V.A.C. at 4 amps. Designed for Army surplus Receivers. #11-109... \$3.00

TRANSTAT VOLTAGE REGULATOR For 60 cycle AC voltage regulation. 103 V—126 V at 2.17 amps. Price: NEW \$9.95

DYNAMOTORS

INPUT:	OUTPUT:	STOCK NO.:	PRICE:
9 V. DC	450 V. 60 MA w. blower	D 9150	\$3.95
12 V. DC	230 V. 100 MA	D 462	3.95
12 V. DC	440 V. 200 MA	D 401	3.95
28 V. DC	F/ SCR 522	PE 94	7.95
12 24 V. DC	F/ No 19 MARK II	P/S #3	9.50
12 26 V. DC	F/ BC-615	PE 101	2.95
12 24 V. DC	500 V. 50 MA	P/S-A/01-1	1.95
28 V. DC	F Comm. Re-celvers	DM 82	1.95
11 V. DC	230 V. 100 MA	DM 20	3.95
12 24 V. DC	440 V. 200 MA and 220 V. 100 MA	D 104	9.95
28 V. DC	400 Cycle Inverter	MG-149F (Reconditioned)	14.95

Address Dept. RE • All Prices Are F.O.B., Lima, Ohio • 25% Deposit on C.O.D. Orders

FAIR RADIO SALES 132 SOUTH MAIN ST. LIMA, OHIO

RECTIFIER UNIT 110 Volt 60 cycle input; output 12 V. DC 10 amps. Can be used to charge batteries or operate DC equipment. Electronic Lab. mfg. Price—NEW \$29.95

NEW TELEVISION ANTENNA ROTATOR

Ideal reversible motor for rotating all types of antennas at the top. Weighs only 3 1/2 lbs. Size: 7 1/2" x 3 1/2". Motor gear box and Mtg.: 4 1/2" x 3 1/2". Motor size: 5 1/2" x 2 1/4" D. Shaft size: 3/8" x 1 1/2" threaded. Operates from 24 V. DC. 3 amps 3.5 RPM or 36 V. A.C. Torque: 70 lbs. per inch. Price \$8.95



TRANSFORMER For above Rotator—110 Volt 60 cycle Primary; 36 V.A.C. Sec. Price \$2.95

ANTENNA POSITION INDICATOR—Ideal for indicating direction of antenna from a remote position. Units are same as illustrated and have 0-360 dial scales. Complete with two autosyns and 12 Volt 60 cycle trans., and wiring instructions. Price \$6.95



SELSYN MOTORS: 115 Volt AC 60 cycle. Size V = C-78238 3 1/2" x 5 1/2". Can be used to turn small antennas or for position indicator systems. Price per Pair \$5.95



Selsyn type 21161—Can be used as antenna position indicators. 110 Volt 60 cycle. Instructions. Normally operates from 57.5 Volts 400 cycle. Price per Pair \$3.00

MOTORS: 6 or 12 Volt AC-DC Heavy Duty reversible Motor with 5/16" x 7/16" shaft. Price: New \$2.95

6 Volt AC-DC Motor—ideal for auto fans, models, etc. Shaft 3/8" x 3/8". Used—Tested \$1.50

Model Motor—12 Volt AC-DC 1/2" double end shaft Motor. Size: 2 1/2" L x 2 1/2" W x 1 1/2" H. Price \$1.50

110 Volt 60 cycle. Ball Bearing Motor. approx. 3500 RPM. 1 1/2 H.P. Shaft: 3/16" x 3/8". Motor size: 6 1/2" L x 4" D. Converted type. Price \$2.95

Hand Tool Motor—12 Volt AC-DC—5600 RPM. 3/4" L x 1 1/4" Dia. with splined shaft 1/4" D x 3/8" L. Price \$2.95

DYNAMOTOR—Use four electric shaver in your car! Dynamotor will supply 110 Volt 100 MA from 6 VDC and will operate most types of AC-DC Shavers. Normal operation 12 VDC input; 220 V. 100 MA output. Price \$1.95

that certain something **EXTRA!**
TACOVISION

It's those many years of TACO antenna engineering and craftsmanship that show up on the TV screen!



Type 925 High-Low Band Antenna. Covers 13 TV channels. Independent orientation for each section. Sectional 10 ft. aluminum mast. Hardware.

Type 445 High-Frequency Adapter. Covers Channels 7-13. Attaches mechanically and electrically to any 300-ohm low-frequency antenna.



Type 960 Extra-High-Gain Low-Frequency Antenna. Channels 2-6. For weak signal areas. 15' mast. All-aluminum. Hardware.

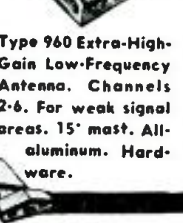

Type 945 Extra-High-Gain High-Frequency Adapter. Channels 7-13. Used alone in high-frequency areas. Attaches mechanically and electrically to any 300-ohm antenna.



Catalog on request. Ask our jobber to show you these TACO jobs.

TECHNICAL APPLIANCE CORP.
SHERBURNE
N. Y.
TACO
Radio and Electronic Equipment

In Canada: Stromberg-Carlson Co., Ltd., Toronto 4, Ontario

LOW-VOLTAGE RECEIVER

This receiver operates with a B-voltage of only 1.5 and A of 4½.

To make the tubes operate with the low plate and filament voltages, the suppressors are used as control grids and the control grids are tied to the screens. Standard plug-in coil assemblies are used.

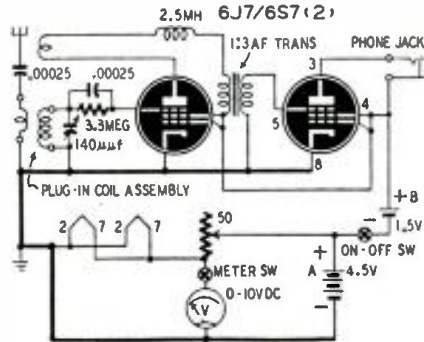

The 0-10 voltmeter is used to keep check on the condition of the A-battery. The 50-ohm rheostat should be adjusted for whatever filament voltage gives the most efficient operation. The original receiver used 6J7's; but if 6S7's are available they should be used, as their 0.15 ampere filament current is only half as great.—*John S. Zverloff*

AUDIO FREQUENCY METER

The audio frequency meter shown in the diagram measures tones from 4 to 40,000 cycles. It is a simple bridge circuit with one reactive arm to make it frequency sensitive. The indicator is a 6E5 electron-ray tube. The potentiometer should be linear. It can be calibrated with a standard audio-frequency oscillator. If no oscillator is available, a microphone and amplifier—with known frequency sources such as a frequency record, tuning forks, or pitch pipes—may be used to obtain a fair calibration curve.

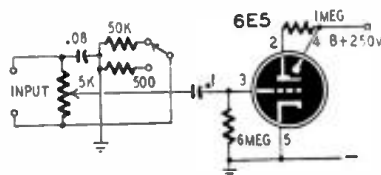

To measure the frequency of a tone, feed it to the input terminals, *neither of which can be grounded*. Adjust the calibrated potentiometer for widest shadow angle on the 6E5.—*D. Bosman*

AUDIO EQUALIZER

The equalizer shown in the diagram will boost or attenuate bass and treble. There is no interaction between the controls. Because of the 6SJ7, there is con-

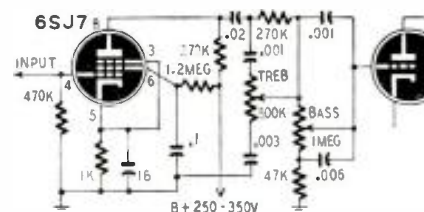

siderable gain, and therefore the unit may be used as part of the low-level section of an amplifier.—*Leon Medler*

An Invitation To **INVENTORS**

Here is the rare opportunity that inventors have been waiting for—to show their inventions at their own exposition and get attention and interest from the public and industry. The primary purpose of this Exposition is to aid inventors in the promotion of their ideas to public and industrial leaders.



First International Inventors Exposition

Sponsored by the American Inventors Association

The International Inventors Exposition is open to any inventor who has any invention—regardless of kind or application—which has merit in the opinion of the Exposition Committee.

In order to make it possible for private inventors to exhibit at the Exposition on an equal footing with commercial entrants, the AIA (American Inventors Association) has made special arrangements for them to join the Association and present their exhibits at a greatly reduced fee.

**GRAND CENTRAL PALACE
NEW YORK CITY
June 4-11, 1949**

This is the first time that inventors from all over the world have had the opportunity to not only show their ideas and products but also gain recognition for themselves.

For complete details and entry application, write, wire or phone the

**Exhibits Committee
INTERNATIONAL
INVENTORS EXPOSITION
Parlor B Shelton Hotel
525 Lexington Ave., New York 17
Plaza 9-5848**

**Remember the Exhibition dates
June 4th to 11th.**

All Inventions Fully Protected

Get Started in Radio

10 "HOW-TO-DO-IT" BOOKS



Get a solid foundation in radio by means of these 10 timely text books. Each clearly written, profusely illustrated, contains over 15,000 words. You'll be amazed at the wealth of information packed into these handy books. Excellent for reference—ideal for technical library. Your money back if not satisfied.

**5 BOOKS for 50c
10 BOOKS for \$1.00
Sent to You Postpaid**

- No. 1—How To Make Four Dozier Short Wave Sets
- No. 2—How To Make The Most Popular All-Wave 1 and 2 Tube Receivers
- No. 3—Alternating Current for Beginners
- No. 4—All About Aerials
- No. 5—Beginners' Radio Circuitary (Leading Terms)
- No. 6—How To Have Fun With Radio
- No. 7—How To Read Radio Diagrams
- No. 8—Radio for Beginners
- No. 9—Simple Electrical Experiments
- No. 10—Television

Item by check or money order—register letter if you send cash or stamps.

RADIO PUBLICATIONS

25M West B'way.

New York (7)

RADIO-ELECTRONICS for

GETTING STARTED ON 160

Now that a portion of the 160-meter band is to be opened to amateurs, many of them are looking for ways of getting their rigs into operation on this band with the least amount of trouble. A frequency-halving circuit and a method of loading short antennas for 160-meter operation, described in *QST*, will permit hams with 80-meter crystals to get on 160 without buying new ones or putting up another antenna.

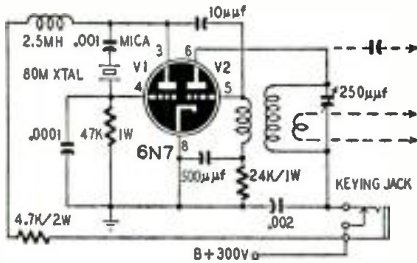

Fig. 1—160-meter exciter uses 4-mc xtals.

The frequency-halving oscillator is shown in Fig. 1. It consists of a Pierce oscillator V1 controlled by an 80-meter crystal and of a tuned-plate self-excited oscillator V2 operating in the 160-meter band. The v.f.o. locks in with a sub-multiple of the crystal and is stabilized by it.

The plate coil has 38 turns of No. 20 d.c.c. wire, close-wound on a 1½-inch form; and the grid coil has 24 turns of No. 26 d.s.c. close-wound at the bottom end of the plate coil.

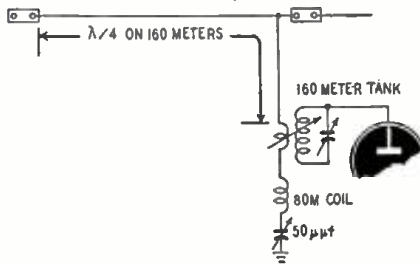

Fig. 2—Loading the 80-meter Zepp on 160.

The output is sufficient to excite almost any of the beam-power tubes normally used in crystal oscillators. The unit can be coupled to the grid of the crystal oscillator, in the rig, through a blocking capacitor or through link coupling.

CAUTION: It may be necessary to experiment with the value of the 10-µf capacitor between the grid of V2 and the plate of V1. If the coupling is too loose, the oscillators will not lock; if it is too tight, the crystal frequency may vary when the variable oscillator is tuned. Adjust this circuit while monitoring the signal.

Fig. 2 shows how an 80-meter Zepp can be used on 160. The feeders are tied together at the transmitter end. Almost any antenna can be used if the sum of the feeder and radiator lengths approximates one-quarter wavelength on 160 meters. The system is tuned by an 80-meter coil and a 50-µf variable capacitor in a series resonant circuit. The plate spacing of the capacitor should be sufficient to prevent breakdown.

TOWERS

FOR
**TELEVISION
ANTENNAS**

OF
**SPRING-TEMPERED
AIRCRAFT
ALUMINUM**

**CLEARER
BRIGHTER
PICTURES
AT GREATER DISTANCES**

ONLY
105
PER
FOOT

- HEIGHTS TO 120 FT.
- INEXPENSIVE
- ATTRACTIVE
- STRONG
- LIGHT (\$1 PER FT.)
- PERMANENT
- EASY TO ERECT

Part No.	Dealer Net	Price
(T-6)-6' Tower Sect.		
K.D. W/Bolts		\$6.30
(K-L)-Basic Kit (Base Top & Mast Brackets)		3.15
(M-12-1) 12' Mast 2" Alum. Tubing		6.75

F.O.B. factory—Include check or designate C.O.D. shipment

SATISFACTION GUARANTEED

ALPRODCO, Inc.
DEPT. R
MINERAL WELLS, TEXAS

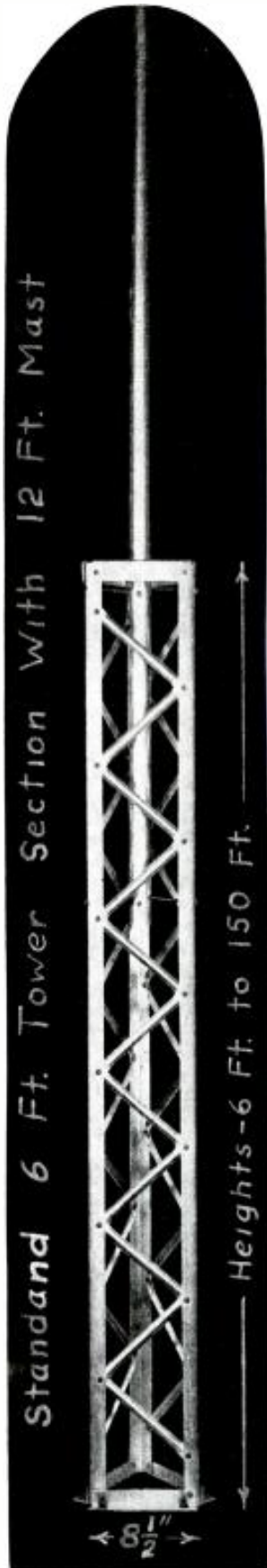

Try This One

TELEVISION SERVICING at a PRICE YOU CAN PAY

R. S. E. 3 inch TELEVISION SCOPE

Features:

- WIDE BAND VERTICAL RESPONSE
- FLAT TO 750kc
- DOWN 3db AT 1mc
- VOLTAGE GAIN OF 20 AT 5mc



AR-3

The R.S.E., AR-3 Scope has been built by Armstrong to our rigid specifications. It's a complete unit that embodies standard horizontal amplifier and sweep circuits with normal sensitivity.

The case is 8" high x 5" wide x 14" long, attractively finished in "hammered" opalescent blue enamel. Operates on standard 110 volts - 60 cycles - 40 watts. Tubes, 3BP1-6AC7-6SJ7-6X5-5Y3-884. Instructions included. Complete specifications upon request. Satisfaction or your money back.

PRICE **\$49.95**

F. O. B. DETROIT

PUSHBACK WIRE



BELOW MILL PRICES!
2,000,000 feet—tinned copper—all 1st. class, double cotton serve, waxed finish. Available 1,000 foot rolls.
22 gauge (6 colors) \$3.98 roll
20 gauge (6 colors) 4.98 roll
18 gauge (brown only) 6.49 roll

MIDGET I. F. TRANSFORMERS



Original List \$2.10

At discounts up to 86%

NOW **36c EACH**

400-500 Kc range 1 1/4" square, 3" high hi-gain iron core.

INPUT—A826 OUTPUT—A827

Specify Type

Matched Pair 69c

Dozen \$3.95

Egg Crate of 100 \$29.00



Demand This Seal of Quality

ORDER INSTRUCTIONS

Minimum order—\$2.00. 25% deposit with order required for all C.O.D. shipments. Be sure to include sufficient postage—excess will be refunded. Orders received without postage will be shipped express collect. All prices F.O.B. Detroit.

RADIO SUPPLY & ENGINEERING CO., Inc.
85 SELDEN AVE. DETROIT 1, MICH.

RECTIFIER TUBE SOCKET

A rectifier tube socket connected as shown will accommodate any of the following tubes without a change in wiring: 5R4-GY, 5T4, 5U4, 5Z4, 5V4, 5W4, 5Y3, 5Y4. This is a useful idea

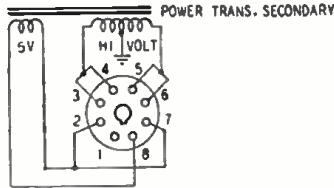

for the amateur or experimenter who has a number of surplus tubes to use as replacements.

E. E. BALDWIN,
Grand Island, Neb.

EXTENDING VOLTMETER RANGE

Many owners of multimeters sometimes have to measure voltages higher than their meters ordinarily will handle. A simple way to extend meter range is to use a test prod with a multiplier resistor built into it. A standard 1/2-watt resistor can be inserted in the handle of most test prods, as shown in the drawing.

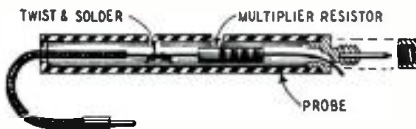

All the information necessary for choosing the correct resistance value is the sensitivity of the meter in ohms per volt, usually given in the maker's instruction book. If the meter has a sensitivity of 1,000 ohms per volt, for example (this is usual), and you want to extend the 300-volt range to read 600 volts, multiply the difference between the old and desired full-scale readings (600 - 300 = 300) by 1,000 (300 x 1,000 = 300,000). For best accuracy, the 300,000-ohm resistor used should have a tolerance of no more than ± 1%. To make the original 300-volt range read 900 volts, use a 600,000-ohm resistor; and so on.

If you choose even multiples of the existing meter scales, you can read the higher values simply by multiplying. For instance, if the 300,000-ohm resistor is used with the 300-volt scale to read a maximum of 600 volts, just multiply any reading by 2. For 900 volts maximum, multiply by 3.

DON HUTCHINSON,
Troy, N. Y.

(If you use multipliers to read voltages around 1,000 or more, be sure to get a high-voltage probe, one with sufficient insulation to protect you from arc-overs and breakdowns.—Editor)

SOLDERING TIPS

It is a good idea to have a number of different-sized and -shaped tips for your soldering iron to take care of fine and coarse jobs and to get into otherwise inaccessible places.

A small depression, large enough to

HARD-TO-GET PARTS

500M Volume Controls 12c, W/Sw	\$0.27
504 Output Trans. 32c, Push Pull	.45
6V6 6P6 Outputs 34c, Push Pull	.45
AC DC Filter Choke	.26
10 Watt Universal Outputs Transformer	.75
Replacement I-F Trans. 450 KC Input or Output Shielded	.32
Same as above but unshielded, in	.25
Supertel Variable Cond. 365mf 2-Gang	.39
TRE Variable Cond. 420mf 44c	.05
Melcher 12SA7 Osc. Coils	.15
Replacement 12SA7 Osc. Coils	.10
Antenna Loops Pin & Sec. 12c, 10 for	1.00
2-Starts JF-30 Xtal. Mikes W/Bases	6.95
Astatic 1X-11Z Dynamic W/47" Grip In Talk	16.50
Chromatium Desk Stand	4.59
Astatic Crystal Mkr. W/Handle	27c, 5 for 1.00
8 Button Push Switch	.22
Solderless Test Prods 5 in. Red or Black	.10
Bayonet Pilot Light Sockets 5c, 3 for	.12
3AG Fuse Extractor Posts	.25
2 Conductor Connectors Male & Female 10	1.00
Tuning Drive Shafts in of out 12c, 10 for	.25
Nylon Dial Cord 25 Feet for	.59
Fluorescent Ballasts 11w, 17w, 20w, ea.	.23
F1-Starters—15-20w 17c, 22w 23c, 30-10w	.12
1 Wire Speaker Cable 1-Ft. Long	.03
Single Lug Terminals 1c, 2 lug 2c, 3 lug	.04
Bakelite Terminal Strips 2 Strips 10cs	.12
PL-55 Microphone Jacks—Open Circuit	.50
Schematic Diagrams for Radios up to 1939	22.95
Elmo 10 Watt HI FI Amplifier, 5 Tube AC	1.95
6V6 PP, 50-15000cp, W Tube, Wired	

Send for Our Latest Bargain Bulletin.
RADIO MAIL ORDERS
2 West Broadway, Dept. RE, N. Y., N. Y.

SCR 522

Receiver and Transmitter only

VHF 100 — 156 MC

Four channel crystal controlled transmitter and receiver. Can be adapted to ham 2-meter band or V.H.F. 2-way taxicab mobile set. Excellent condition.

Price Complete with Tubes..... \$40.00

PHADICK SALES CORP.

165 Broadway New York City

Low FACTORY-TO-YOU Prices

New! MIDWEST TELEVISION

with BIG 75 Square Inch SCREEN

Offering

- 12 1/2" PICTURE TUBE
- 12 TELEVISION CHANNELS
- PICTURE-HOLD CONTROL

Other Models Include:
SYMPHONY GRAND AM-FM RADIO-TELEVISION-
PHONOGRAPH with
DUAL-SPEED RECORD
PLAYER



EASY TERMS

30 DAYS TRIAL

Also Sensational NEW MIDWEST RADIOS with DUAL-SPEED Phonograph

Send for TELEVISION Folder, Prices and NEW 1949 MIDWEST RADIO Catalog

MIDWEST RADIO & TELEVISION CORP.
Dept. T-389, 909 Broadway, Cincinnati, Ohio

Name: _____
Address: _____
City: _____ State: _____

hold a drop of solder, in one surface of the iron is useful for transferring solder to hard-to-reach connections.

N. SCHVEDMAN,
Kew Gardens, N. Y.

COLOR CODING

Applying spots of colored paint to resistors and terminals in a chassis is often useful for coding. Instead of a brush, use a pipe cleaner. It does not have to be cleaned when the color is to be changed. All that is necessary is to clip off the end that has been dipped in the paint.

O. C. VIDDEN,
Fertile, Minn.

TEMPORARY CONNECTORS

Small steel springs are very useful on the experimenter's bench for making temporary connections between wires. The ends of the two pieces (or more) of wire can be inserted between the coils. If the spring is close-wound, it will grasp the wires tightly.

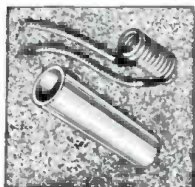

The connections can be insulated quickly by slipping a small length of rubber tubing over the spring and wires.

G. GARVIN,
South Bend, Ind.

PICK-UP TOOL

A wooden rod about 1/4 inch in diameter and having a blob of wax firmly stuck on the end is very useful for picking up small parts in inaccessible places or starting nuts in cramped quarters.

AUGUSTINE MAYER,
Tiffin, Ohio

LONG-WIRE ANTENNA

I carry a 40-80-meter transmitter in my car and frequently must erect a long-wire antenna. To simplify erecting and taking down the antenna I use a deep-sea fishing rod and reel.

A good length of strong fishing line is wound on the reel first. Then the end of a 134-foot length of phosphor-bronze (surplus) antenna wire is tied to the end of the line and wound on the reel.

On arrival at a location, I dismount the reel from the rod and tie the rod to the side of the car (see drawing).

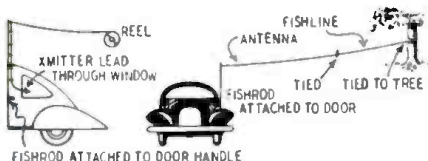

The end of the wire is passed through the top guide of the rod, through subsequent guides, and into the car window. Then, walking backward, I carry the reel, letting the wire pay out.

Eventually the wire is all unreeled and I tie the fish line to a tree. The line acts as an end insulator. To fold up and move on, the process is simply reversed.

R. L. BRIDGES, W6PMU,
Los Angeles, Calif.

A WIDE RANGE
HIGH QUALITY
...
INSTRUMENT

the new improved
ESPEY 511 AM-FM RADIO

- Here is a fine radio, in chassis form, to please the most discriminating music lovers.
- Easy to install in any console cabinet old or new, the Espey 511 AM-FM radio chassis embodies the latest engineering refinements for lasting high quality and enjoyment at a price that defies competition.
- Features, 12 tubes plus rectifier and tuning indicator; drift compensated circuit for high frequency stability; tuned RF on AM and FM, high fidelity push-pull audio; 13 watts power output; wide range 12" PM speaker; smooth flywheel tuning; phono input provision; separate AM and FM antennas.

Other models available including 25 watt output.

Write Dept. K for your free catalog.

Makers of fine radios since 1928.

ESPEY MANUFACTURING COMPANY, INC.

528 EAST 72nd STREET, NEW YORK 21, N. Y.

TEL. BUtterfield 8-2300



EASY TO LEARN CODE

It is easy to learn or increase speed with an Instructograph Code Teacher. Affords the quickest and most practical method yet developed. For beginners or advanced students. Available tapes from beginner's alphabet to typical messages on all subjects. Speed range 5 to 40 WPM. Always ready—no QRX.

ENDORSED BY THOUSANDS!

The Instructograph Code Teacher literally takes the place of an operator-instructor and enables anyone to learn and master code without further assistance. Thousands of successful operators have "acquired the code" with the Instructograph System. Write today for convenient rental and purchase plans.



INSTRUCTOGRAPH COMPANY

4701 Sheridan Rd., Dept. RC, Chicago 40, Ill.

GREYLOCK RADIO TUBE BARGAINS!

GT, Glass and Miniature Types

1R5	304	12SA7GT	} 39¢ each
1S5	3V4	12SK7GT	
1T4	6AT6	12SQ7GT	
1U4	6BA6	(and many others)	
3S4	6BE6		

SPECIAL OFFER! All above types may be purchased in lots of 100 assorted, at \$35 per 100.

6AK5	} 49¢ ea.	2E24	} 89¢ ea.
6AG3		6BG6G	
6J6		1B3-8016	

All tubes in individual cartons

TERMS: Net C.O.D., F.O.B. NYC. MINIMUM ORDER \$5.00.

Write for Bargain Catalog C-5
Greylock Electronics Supply Co.
30 Church Street New York 7, N. Y.

World-Wide Station List

By ELMER R. FULLER

WITH the issue we are again printing the Station List after an absence of two months. An FM Station List appeared in the February issue and a list of television stations in March. A list of Canadian FM stations is printed this month, on page 85.

Incidentally, many dx reports have been received on FM. Possibly more significant are the occasional dx television reports. These are necessarily rather rare, since few people with television sets are to be found in regions remote from broadcasters. However, the television frequencies are inherently better suited for distance reception, and as television sets become more numerous, we are likely to hear more about television reception over distances of several hundred miles. We are very anxious to obtain verified reports of such long-distance reception, and especially of repeated reception of television programs at distances of 200 miles and more.

You Can't Match these MID-AMERICA Values!

ELECTRIC MOTOR SCOOP!



115-volt 60 cycles
Get this motor and make the handiest tool on your workbench! Attach a flexible shaft and you're all set for grinding, sanding and buffing operations. Great for model-makers 1/20 i.d. motor turns at 2900 RPM—does the job in half the time. 1/4" shaft, 3/8" long, 3 3/4" x 2 3/4" x 3 3/4" high; weighs only 3 3/4 lbs. May be used for many motor applications.

\$3.95

THIS MONTH'S SPECIALS

- Brand New Throat Microphone \$0.19
- Lever Action Switch with Knob (3 pos. 2-SP3P and 1-SP2T; spring return)29
- 8" PM Speaker, 50L6 Transformer 3.95
- Brand New RC-366 Jack Box19
- 6-volt AC/DC Motor, 1/4" shaft; app. 3" long, 2 1/2" dia. Used, sold as is98

Plate Load RELAY



6000-ohm coil, SPST normally open contacts. Extra sensitive and used for many applications. 1 1/2" high, 1 3/4" wide, on 1 1/2" mtg. ctra. MA-1903 \$1.19

METAL CAN ELECTROLYTICS



- MA-50868 30-20 mfd. 450 VDC \$0.39
- MA-50866 15/15 mfd. 450/350 VDC39
- MA-50865 30-15/15/40 mfd. 450/350/25 VDC38
- MA-50871 20-20 mfd. 450V39

Silver Mica Button Condensers

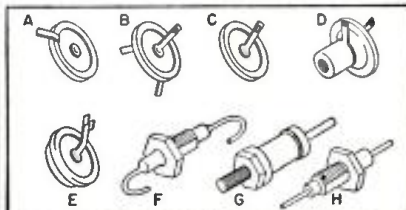

\$7.50 per 100 (all one type)

- MA-3536 (G) 20 mmf MA-3505 (C) 360 mmf
- MA-3501 (D) 30 mmf MA-3509 (A) 500 mmf
- MA-3531 (F) 55 mmf MA-3506 (B) 500 mmf
- MA-3503 (A) 75 mmf MA-3510 (C) 500 mmf
- MA-3532 (H) 75 mmf MA-3502 (D) 500 mmf
- MA-3504 (A) 200 mmf MA-3507 (E) 500 mmf
- MA-3519 (F) 250 mmf MA-3518 (A) 2000 mmf

#18 2-conductor Wire & Drum

Used for running 110-volt AC lines, extension speakers, etc. Full 175 feet of highest quality wire with tough, weather-resistant insulation. Complete with handy drum for spooling wire for storage. Limited quantity **\$2.39**

BRAND NEW METERS

DeJur Model 310 meter for all-around ham and test applications. 10 ma DC basic movement, 3/4" diameter flange; 2 3/4" body, 1 1/2" deep. Stock up on these while they last. MA-2036 **\$1.95 each**



ORDER FROM THIS AD!

Send 25% deposit with order. Pay balance plus postage on delivery. Get your name on Mid-America's select mailing list and get first crack at latest, greatest values in radio parts, electronic equipment, tubes, etc. Send orders to Desk RC-59. Minimum order \$2.50.

MID-AMERICA CO. Inc.

STORE: 2412 S. Michigan Ave., Chicago 16, Ill.
WAREHOUSE: 2307 S. Archer Ave., Chicago 16, Ill.

DON'T TURN THIS PAGE UNTIL YOU SEE THESE RED HOT SPECIALS! THEN COMPARE

HIGH FIDELITY



FM/AM CUSTOM CHASSIS

Complete with 12" Speaker & Dipole 13 Tubes includes 2-6V6 PP for Power Output, driven by a balanced Phase Inverter circuit consisting of a pair of 6AT6's.—Phono Input & Selector Switch. FM Coverage 8.8 MC—108MC. AM/540KC-1700 KC. Response: 50 to 10,000 cps (3db down), 105-125 Volts A.C. Underwriters Approved Reg. List \$169.00. Write for full Specs. ONLY **\$64.50** Complete

TUBES

3525 GT \$.39
50L6 GT59
12SQ7 GT59
12SK7 GT59
12SA7 GT69
ABOVE TUBES IN KIT.... 2.60

Here's a **SENSATIONAL BUY!**

Lp 45 RPM & COLUMBIA ATTACHMENT

Now play both these new records with this low priced, Dual speed attachment. 7 Gram Crystal Pickup complete with Permanent Needle. 110 Volts **\$14.95** A.C. Lots of 3 **\$13.95**

PORTABLE PHONOGRAPH KIT-COMPLETE \$11.95

We were swamped last month when we ran this special—Best Buy Anywhere—complete, nothing else to buy. 2 Watt Amplifier—5" PM Speaker—Complete Instructions. Factory wired and tested. **\$13.95** Lots of 3. **\$12.95**

ASTATIC CRYSTAL PICKUP

Replaces 99% of all pickups on market today. Choice of L-82A High Output or L-70 Low Output Crystals. Complete with H'drws. Special Only **\$1.69** Lots of 10.....\$1.59 25% Deposit—Balance C. O. D.

UNITED RADIO DIST.
Dept. "R", 170 Marcy Ave., Brooklyn 11, N.Y.

Freq.	Station	Location and Schedule
2.500	WWV	WASHINGTON, D.C.: U.S. Bureau of Standards; continuous, day and night
3.310	VVIRO	TRUJILLO, VENEZUELA: 1700 to 2130
3.370	VVIRT	MARACAIBO, VENEZUELA: 1730 to 2230
3.400	VV5RW	CARACAS, VENEZUELA: 0530 to 0800; 0955 to 1430; 1530 to 2130
3.420	VV2RC	MERIDA, VENEZUELA: 1800 to 2130
3.440	VV1RU	MARACAIBO, VENEZUELA: 0530 to 0830; 1030 to 2230
3.460	VV4RP	VALENCIA, VENEZUELA: 1730 to 2130
3.480	VV4RQ	PUERTA CABALLO, VENEZUELA: 1700 to 2130
3.480	ZQI	JAMAICA, BRITISH WEST INDIES: 1600 to 1730; 1930 to 2200
3.490	VV3RS	BARQUISIMETO, VENEZUELA: 1630 to 2130
3.500	VV5RX	CARACAS, VENEZUELA: 0930 to 1400; 1530 to 2230
3.510	VV6RC	BARQUISIMETO, VENEZUELA: 1800 to 2130
3.530	VV5RS	CARACAS, VENEZUELA: 0530 to 2230
3.910	ZQP	LUSAKA, NORTHERN RHODESIA: 0400 to 0530; 1000 to 1200
4.750	VV1RV	MARACAIBO, VENEZUELA: 0930 to 2130
4.780	VV4RO	VALENCIA, VENEZUELA: 1630 to 2130
4.780	HJAB	BARRANQUILLA, COLOMBIA: 1700 to 2255
4.810	VV1RL	MARACAIBO, VENEZUELA: 0530 to 2230
4.810	HJBB	CUCUTA, COLOMBIA: 1700 to 2200
4.820	XEJG	GUADALAJARA, MEXICO: 2200 to 2400
4.820	HJED	CALI, COLOMBIA: 1900 to 2300
4.830	VV2RN	SAN CRISTOBAL, VENEZUELA: 1100 to 2130
4.340	VV1RZ	VOLEIRA, VENEZUELA: 1030 to 2145
4.850	HJCA	BOGOTA, COLOMBIA: 1900 to 2200
4.860	PRC5	BELEM, BRAZIL: 0600 to 0700; 0900 to 1100; 1530 to 2000 except Sundays
4.880	HJFH	ARMENIA, COLOMBIA: 0600 to 2200
4.890	HJCH	BOGOTA, COLOMBIA: 1800 to 2200
4.900	ZOH	COLOMBO, CEYLON: 0900 to 0330; 0345 to 1145; 2100 to 2145
4.920	CR7BU	LOURENCO MARQUES, MOZAMBIQUE: 1000 to 1600
4.920	VV5RN	CARACAS, VENEZUELA: 0600 to 2230
4.940	HJCV	BOGOTA, COLOMBIA: 0645 to 1115; 1600 to 2315
4.950	HC5HC	RIOBAMBA, ECUADOR: 1800 to 2300
4.950	ZQI	JAMAICA, BRITISH WEST INDIES: 1600 to 1730
4.960	HJAE	CARTAGENA, COLOMBIA: 1600 to 2230
4.990	VV3RS	BARQUISIMETO, VENEZUELA: 1630 to 2130
5.000	WWV	WASHINGTON, D.C.: U.S. Bureau of Standards; continuously day and night
5.020	VVRO	CARACAS, VENEZUELA: 2000 to 2230
5.870	HRN	TEGUCIGALPA, HONDURAS: 0800 to 1000; 1300 to 1500; 1800 to 2300
5.880	ZRK	CAPTOWN, SOUTH AFRICA: 0315 to 0915; 1200 to 1600
5.940	RV15	MOSCOW, U.S.S.R.: 0300 to 0930; 1530 to 1820; 2100 to 0015
5.970	HJV	VATICAN CITY: 1345 to 1515
5.970	HC1QRX	QUITO, ECUADOR: 0700 to 0815; 1200 to 1400; 1800 to 2300
5.980		ANDORRA: 0600 to 0830; 1300 to 1900
5.890	OAX4Z	LIMA, PERU: 1630 to 2330
5.910	OZX4V	LIMA, PERU: 1800 to 2400

Table with columns: Freq., Station, Location and Schedule. Lists radio stations globally with their frequencies and broadcast times.

OPPORTUNITY AD-LETS

Advertisements in this section cost 25c a word for each insertion. Name, address and initials must be included at the above rate.

12B8 & 25B8 TUBES, ADAPTER UNIT USING 2 miniature tubes (6AT6 & 6BA6 for 12B8, and 12AT6 & 12AB6 for 25B8).

BARGAINS: NEW AND RECONDITIONED HALL-creators, National Collins, Hammarlund, Meissner, R31E, other receivers, tuners, television receivers, transmitters, etc.

AMATEUR RADIO LICENSES, COMPLETE THEORY preparation for passing amateur radio examination. Home study and resident courses.

BARGAIN HUNTING? RADIO SERVICEMEN WRITE. Sensational catalog. Henshaw Radio Supply, 3619 Troost, Kansas City 3, Missouri.

RECORD CHANGER PARTS for leading makes of changers. We ship everywhere. Mail orders invited!

WANTED: Salesmen to sell Nationally Advertised Brand Radio Tubes to Dealers and Servicemen at liberal discounts.

MAGAZINES (BACK DATES)—FOREIGN, DOMESTIC, arts, books, booklets, subscriptions, pin-ups, etc.

SELECTED GROUP OF MEN, GRADUATES OF WELL-known trade school, desire employment in Radio Field.

WE REPAIR ALL TYPES OF ELECTRICAL INSTRUMENTS, tube checkers and analyzers.

LANCASTER, ALAINE & ROMMEL, 436 BOWEN Building, Washington 5, D.C. Registered Patent Attorneys.

TELEVISION, RADIO, TUBES, PARTS, SEND FOR free bargain list. Hallmark, 592A Communipaw, Jersey City, New Jersey.

RADHOME, SERVICEMEN, BEGINNERS — MAKE more money, easily, quickly. \$250 weekly possible.

EVERYONE CAN MAKE EASY MONEY INSTANTLY! Radio training unnecessary. Top-quality—quick selling—new plastic scientific Television Filter made specifically for TV!

Send for 30 Years Proved Radio Repairing Simplified System; \$1.00. Box 178E, Lake Hiawatha, New Jersey.

HEARING AIDS—Reconditioned. Make wonderful miniature radios. \$20.00 complete with cord, earphone, Shelby Instrument, 321 West 7th St., Long Beach, Calif.

ALUMINUM TUBING, ANGLES, SHEETS AND FITTINGS. Write for list. Willard Radcliff, Fostoria, Ohio.

RADIO TUBES, ALL POPULAR TYPES \$37.00 FOR 50. Itelradio Tube Co., O'Neill, Neb.

ELECTRONICS KIT Builds AC-DC voltmeter, oscillator, electric eye, \$2.95 complete. Literature Free. Precise Measurements Co., 942E Kings Highway, Brooklyn, N. Y.

ANY RADIO-ELECTRONICS TEXT BOOK RENTED—1-2¢ per day. Address: TBRA, 780 East 214th St., New York, N. Y.

For Sale—Best radio-refrigeration shop in Ozarks, sportsman's paradise. Wilson Radio, Thayer, Missouri.

27 years experience radio repairing. Simplified system. No calculations. No formulas. Total price \$2.00 postpaid or C.O.D. Moneyback guarantee. Ross Radio, 11615 Grand-river, Detroit 27, Mich.

Heath's Vacuum tube voltmeter, new, wired, complete, ready to use, accurate, best looking meter on market \$15.50. Ernest Santalla, 42-35 64th Street, Woodside, N. Y.

PHONOGRAPH RECORDS CHEAP. CATALOGUE, Paramount, BJ-313 East Market, Wilkes-Barre, Penna.

TELEPHONE DIALS, NEW AUTOMATIC ELECTRIC standard AX-11 \$3.25 postpaid. Used N-E Type-1, rebuilt \$2.25. Re-adjusted \$1.25 postpaid. Kissel Electric Products, 431-C Sherman, Gallon, Ohio.

Keep posted on Electron Tubes



MAIL COUPON TODAY

RCA, Commercial Engineering Section 49EW, Harrison, N. J. Send me the RCA publications checked below.

- Name _____
Title or Occupation _____
Address _____
City _____ Zone _____ State _____
 Quick-Reference Chart, Miniature Tubes (Free) (A)
 HB-3 Tube Handbook (\$10 in U.S. & possessions) (B)
 RC-15 Receiving Tube Manual (35 cents) (C)
 Receiving Tubes for AM, FM, and Television Broadcast (10 cents) (D)
 Radiotron Designers Handbook (\$1.25) (E)
 Quick Selection Guide, Non-Receiving Types (Free) (F)
 Power and Gas Tubes for Radio and Industry (10 cents) (G)
 Phototubes, Cathode-Ray and Special Types (10 cents) (H)
 RCA Preferred Types' List (Free) (I)
 Headliners for Hams (Free) (J)

Also available from your RCA Tube Distributor

RCA TUBE DEPARTMENT RADIO CORPORATION OF AMERICA HARRISON, N. J.

Convert Battery Radios to ALL-ELECTRIC

OPERATE-SERVICE
DEMONSTRATE-
TEST



Electro
ELECTRICAL AND RADIO EQUIPMENT

with

ELECTRO BATTERY ELIMINATORS

for only a few cents per hundred hours

Use radio for unlimited time without fading. Completely eliminates fussing with batteries. Easy to install—simple to use. Fits in battery compartment of most radios. Convenient, permanent, on-and-off switch.

Will operate in any position—nothing to spill, nor get out of order. Free of hum, completely filtered, silent in operation. Universal plugs and sockets fit any radio. Durable finished in handsome blue Hammeroid.

MODEL "S"—WITH SELENIUM RECTIFIER
Operates any 1.4 volt—4, 5 or 6 tube Battery Radio from 115 volt 60 cycle source.

MODEL "P"—COMPACT
Same as Model "S" except has tube rectifier at lower cost. Also available for 220 volt operation.

MODEL "F"—Operates 2 volt, 4, 5, 6 or 7 tube radio from 115 volt 60 cycle source. 10.5 amp. (Mount box.)

WRITE FOR COMPLETE INFORMATION

ELECTRO PRODUCTS LABORATORIES

Pioneer Manufacturer of Battery Eliminators

549 W. Randolph St., Chicago 6, Illinois

Freq.	Station	Location and Schedule
7.100		BISSAU, PORTUGUESE GUIANA: 1315 to 1730
7.120	GRM	LONDON, ENGLAND: 1145 to 1215; 1415 to 1715; 2330 to 2345
7.130	VQ6MI	HARGEISA, BRITISH SOMALI-LAND: 0800 to 1030; 1200 to 1300
7.150	XGOY	CHUNGKING, CHINA: 0530 to 0730; 0745 to 0945; 1000 to 1045
7.160	KWS4	VIENNA, AUSTRIA: 2345 to 2030
7.220		SINGAPORE, MALAYA: 2330 to 0130
7.250	PJC1	WILLEMSTAD, CURACAO: 1130 to 1230; 1630 to 2130
7.250	MUNICH II	MUNICH, GERMANY: Balkan beam: 1100 to 1700
7.260	GSU	LONDON, ENGLAND: 2315 to 2330; 2345 to 0130; 1000 to 1700
7.230	JLW	TOKYO, JAPAN: Home Service, 0300 to 0500; 1600 to 1800; 2200 to 0230
7.290	VUD3	DELHI, INDIA: 0800 to 1100; 1730 to 1825; 2100 to 2300
7.290	ZOY	ACCRA, GOLD COAST: 1045 to 1300
7.300		MOSCOW, U.S.S.R.: 1100 to 1615
7.310	YSN	SAN SALVADOR, SALVADOR: 1300 to 1500; 1900 to 2300
7.410	PSTA2	SAO PAULO, BRAZIL: except Saturdays and Sundays, 1800 to 2000
7.570	EAJ43	SANTA CRUZ, CANARY ISLANDS: 0730 to 0900; 1200 to 1700
7.850	ZAA	TIRANA, ALBANIA: 1300 to 1700
7.850	SUX	CAIRO, EGYPT: 1400 to 1920
7.920	HLKA	SEOUL, KOREA: 0250 to 0830; 1630 to 1830; 2100 to 2400
7.950		ALICANTE, SPAIN: 0700 to 1000; 1100 to 1800
7.950		DOUALA, CAMEROONS: 1300 to 1500
8.030	FXE	BEIRUT, LEBANON: 0800 to 0115; 0715 to 0800; 1030 to 1600
8.700	COCQ	HAVANA, CUBA: 0800 to 0100
8.850	COCQ	HAVANA, CUBA: 0700 to 0100
8.920	COKG	SANTIAGO, CUBA: 0600 to 2300
9.030	COBZ	HAVANA, CUBA: 0700 to 0100
9.080	CNR3	RABAT, MOROCCO: 0145 to 0500; 1315 to 1900
9.160	CR6RB	BENGUELA, ANGOLA: 1330 to 1100
9.210	H12G	CIUDAD TRUJILLO, DOMINICAN REPUBLIC: 0530 to 0830; 1300 to 1700; 1700 to 1815
9.230	COBQ	HAVANA, CUBA: 0800 to 1200; 1730 to 2330
9.270	COCX	HAVANA, CUBA: 0700 to 0030
9.330		SOFIA, BULGARIA: 2300 to 0100; 0530 to 0700; 1100 to 1330; 1500 to 1745
9.370	EAQ	MADRID, SPAIN: 1330 to 1600; 1830 to 2200
9.380	COBC	HAVANA, CUBA: 0700 to 2400
9.380	OTC	LEOPOLDVILLE, BELGIAN CONGO: 0800 to 0200; 1100 to 1500
9.420		BELGRADE, YUGOSLAVIA: 0800 to 1230; 1630 to 0845; 1000 to 1015; 1110 to 1125
9.440	FZ1	BRAZZAVILLE, FRENCH EQUATORIAL AFRICA: 0600 to 0230; 1100 to 1230; 1500 to 2030
9.460	TAP	ANKARA, TURKEY: 1000 to 1615; Sun., Mon., Thurs., 1530 to 1545
9.470	CR6RA	LOUANDA, ANGOLA: 0115 to 0230; 0630 to 0715; 1300 to 1530
9.470		WILLEMSTAD, CURACAO: 1300 to 1600
9.480		MOSCOW, U.S.S.R.: 0600 to 0900
9.500	XEW7	MEXICO CITY, MEXICO: 0800 to 0200
9.500	O1X2	LAHTI, FINLAND: 0350 to 0730; 1000 to 1600; 2300 to 2100
9.510	JL62	TOKYO, JAPAN: 0300 to 0830
9.520	VLW7	PERTH, AUSTRALIA: 0230 to 1020; 1000 to 1000
9.520	ZRG	JOHANNESBURG, SOUTH AFRICA: 0800 to 1045
9.520	OZF	COPENHAGEN, DENMARK: 1900 to 2330
9.520	SEAC	COLOMBO, CEYLON: 1930 to 1200
9.530	WGED	SCHENECTADY, NEW YORK: South American beam, 1900 to 2200
9.530	SBU	STOCKHOLM, SWEDEN: 2000 to 2100
9.540	VLR	MELBOURNE, AUSTRALIA: 0800 to 0915; 0930 to 1000; 1245 to 1115
9.540	LKJ	OSLO, NORWAY: 0125 to 0230
9.540	MUNICH II	MUNICH, GERMANY: East European beam, 1100 to 1700
9.540	CJCA	EDMONTON, CANADA: 0815 to 0200
9.550	XETT	MEXICO CITY, MEXICO: 0700 to 0100
9.550		PARIS, FRANCE: 2100 to 2130

NEW IMPROVED PR7 MODEL

POLICE FM ALARM

FOR POLICE CALLS TAXI CABS AND OTHERS

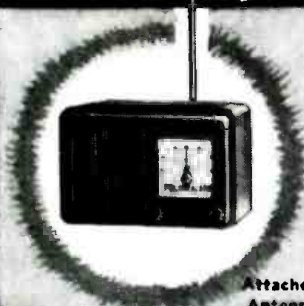

Attached Antenna

Tunes 152-162 Megacycles

F. M. Superheterodyne, 115 Volts, A.C.—D.C. Tubes—12AT7, (2) 6BJ6, 19T8, 35B5, 35W4. 2 stages high gain 10.7 Megacycle I.F.'s. Radio detector. Plastic cabinet 10 1/2 x 6 3/4 x 6 deep. Schematic and instructions. Shipping weight 7 lbs. Sensitivity 10 Microvolts or better. Selectivity 250 K.C.'s or better. Reception expectancy with attached antenna from 50 Watt transmitter 3 miles, much farther from transmitter of more power or outside antenna. Ready to plug in and use; 28 Watts power consumption.

\$39.95

Slightly higher West Coast Excise Tax Included F.O.B. Indianapolis \$10.00 with order, rest C.O.D.

SEE YOUR DEALER FIRST OR WRITE

DELUXE CA-2 COAXIAL ANTENNA FOR BEST RECEPTION—LIST

\$5

RADIO APPARATUS CORP. 303 FOUNTAIN SQ. THEATER BLDG. INDIANAPOLIS 3, INDIANA

Booklets by A. C. Shaney
Written by a foremost Audio design engineer—
Yours almost as a gift!

Elements of Magnetic Tape Recording and 999 Applications 25c
Direct-Coupled FM-AM Amplifier Manual 25c
20 Steps to Perfect Amplification 3c in postage

Thousands Sold!

Famous Twin-Trax Instruction Book! Practically a course in tape recording. 30 diagrams, illustrations. \$2.50 (Price may be applied against future purchase of chassis.)



AMPLIFIER CORP. OF AMERICA

398-10 Broadway New York 13, N. Y.

TELEVISION RECEIVER—\$1.00

Complete instructions for building your own television receiver. 16 pages—11"x17" of pictures, pictorial diagrams, classified schematics. 17"x22" complete schematic diagram & chassis layout. Also booklet of alignment instructions, voltage & resistance tables and troubleshooting hints.—All for \$1.00.

CERTIFIED TELEVISION LABORATORIES
Dept. C, 5507-13th Ave., Brooklyn 19, N. Y.

FREE

Send name and address for our free catalogue, chock-full of standard brand radio and TV sets, parts and equipment at rock bottom bargain prices.

COMMERCIAL RADIO, DEPT. C
36 Brattle St. Boston 8, Mass.

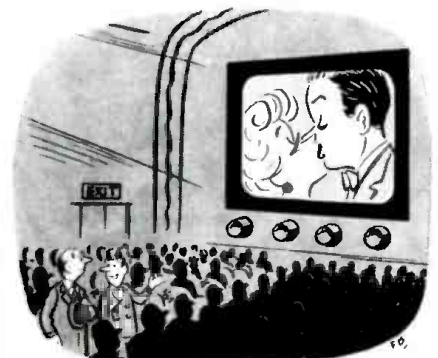

"We had to fake a Television effect to make folks feel at home."
Suggested by H. Rosier, Milwaukee, Wis.

RADIO-ELECTRONICS for

Freq.	Station	Location and Schedule
9.560		KOMSOMOLSK. U.S.S.R.: 2100 to 2400
9.560		VIENNA, AUSTRIA: 0000 to 0200; 0400 to 0830; 1000 to 1600
9.570	KWID	SAN FRANCISCO, CALIFORNIA: Chinese beam: 0700 to 1000
9.570	WRUW	BOSTON MASSACHUSETTS: South American beam: 2000 to 2200
9.570	KWIX	SAN FRANCISCO, CALIFORNIA: Alaskan beam: 2215 to 0345
9.580	GSC	LONDON, ENGLAND: 1330 to 1345; 1430 to 1530; 1600 to 1615; 1815 to 2030
9.580	VLH3	MELBOURNE, AUSTRALIA: 0345 to 0830; Sat.: 0215 to 0900; Sun.: 0330 to 0830

CANADIAN FM STATIONS

While Canada has not yet started its television efforts in earnest, FM in the Dominion is advancing. The following list of Canadian FM stations enumerates all those in operation as of February 21, 1949. It includes those which are owned by the Canadian Broadcasting Corporation (the four in Montreal, Toronto, and Vancouver, and CBO-FM in Ottawa) as well as privately owned outlets. There are 22 altogether, which is twice the number in operation in April, 1948. All stations are operating with a nominal power of 250 watts except for CFPL-FM, London, which uses 3,000.

CITY	CALL	FREQUENCY
	ALBERTA	
Edmonton	CKUA-FM	98.1
	BRITISH COLUMBIA	
Vancouver	CBR-FM	105.7
	MANITOBA	
Winnipeg	CJOB-FM	103.1
	NEW BRUNSWICK	
Saint John	CHSJ-FM	100.5
	NOVA SCOTIA	
Holifax	CHNS-FM	96.1
Sydney	CJCB-FM	94.9
	ONTARIO	
Fort William	CKPR-FM	94.3
Hamilton	CHML-FM	94.1
Kingston	CKWS-FM	96.3
Kirkland Lake	CJKL-FM	93.7
Kitchener	CKCR-FM	96.7
London	CFPL-FM	93.5
Ottawa	CBO-FM	103.3
Ottawa	CFRA-FM	93.9
Sarnia	CHOK-FM	97.5
Sault Ste. Marie	CJIC-FM	100.5
Timmins	CKGB-FM	94.5
Toronto	CBL-FM	99.1
Windsor	CKLW-FM	93.9
Woodstock	CKOX-FM	106.9
	QUEBEC	
Montreal	CBF-FM	100.7
Montreal	CBM-FM	95.1



Suggested by: E. A. Conklin, Denver, Colorado
 "So that's what you mean by 'point to point testing,' eh?"

YOUR BEST VALUE

IS IRC POWER WIRE WOUNDS

By any comparison, IRC is your biggest value in Power Wire Wound Resistors. Examine the extra features you get with these dependable IRC heavy duty resistors.

The exclusive moisture-proof coating is designed to the known scientific principle that a dark, coarse surface dissipates more heat more rapidly than a smooth, shiny surface. This means better performance.

For easier installation, IRC provides both lead and lug on the same terminal. Lugs may be clipped for space saving in crowded chassis, and heavy tin dipping assures easy soldering. Resistor ends are clean and free of coating—permitting easy vertical mounting with tie-bolts. Bracket mountings are available for larger power wire wound types. Clear identification of type and range on every IRC Power Wire Wound is permanent... for easy, accurate replacement.

And here's a feature that should not be taken for granted—IRC Power Wire Wounds handle full rated power. No derating is required at high ranges.

When you buy power wire wound resistors, always ask your distributor for IRC—most for your money by any comparison. International Resistance Co., 401 N. Broad Street, Philadelphia 8, Pa. In Canada: International Resistance Co., Ltd., Toronto, Licensee.

INTERNATIONAL RESISTANCE CO.

Wherever the Circuit Says ~~~



fixed and adjustable types in wide range of ratings, sizes and terminal types.

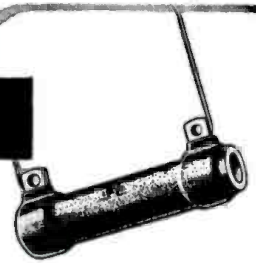

COMPARE THE COATING
 dark and rough for rapid heat dissipation.

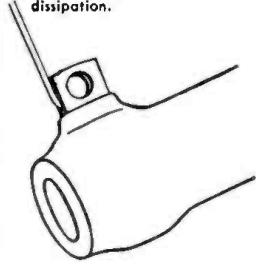

COMPARE THE TERMINALS
 both lead and lug on same heavily tinned terminal.

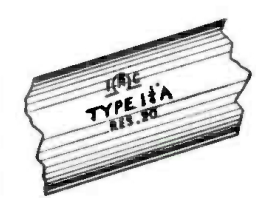

COMPARE IDENTIFICATION
 permanent marking shows type, size and resistance—will not fade.

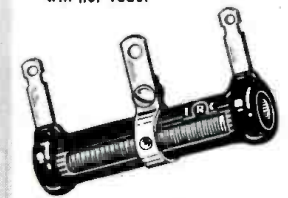

COMPARE PERFORMANCE
 IRC PWW's handle full rated power—no derating required at high ranges.

HOW TO GET THE MOST
 from only
BASIC TEST EQUIPMENT

Servicing by Signal Substitution

The Simple, Modern, Dynamic Speed approach to receiver alignment and adjustment problems, FM-AM-TV.

- Nothing complex to learn
- No extra equipment to purchase
- Universal — non-obsolete
- Employs only Basic Test Equipment

S-S-S tells HOW — in simple, direct language.

New 9th edition now off the press. 100 pages of valuable information.

Available from all leading radio parts and equipment distributors or directly from factory at only 40¢ per copy.

PRECISION APPARATUS COMPANY, Inc. • 92-27 Horace Harding Blvd., Elmhurst 4, N. Y.

THE PRICES SPEAK FOR THEMSELVES

EVERYTHING NEW AND GUARANTEED

35W4	Hytron	.34
6SQ7	General Electric	.29
VT241	National Union	.09
24A	Kenrad	.69
47	R.C.A.	.79
76	Philco	.29
45Z5	General Electric	.49
12SR7	Kenrad	.29
6C4	Kenrad	.19
50L6	Kenrad	.55
35Z5	Kenrad	.39
12SQ7	Kenrad	.49
12SA7	Kenrad	.55
12SK7	Kenrad	.54
OZ4	Stand. Brand	.69
5U4	Kenrad	.59
5V4	Sylvania	.85
6K7	R.C.A.	.49
50A5	Sylvania	.79
50B5	Sylvania	.55
35Y4	Sylvania	.69

Substitutes of other standard brands will be made if listed brands are out of stock

AC-DC CHOKE, 50ma, 10hy.....	\$.17
ONE POUND ROSIN SOLDER.....	.59
SOLDERING IRON, 100W., list \$3.95	1.97
LINE CORD, 6 feet with plug.....	.12
ANTENNA HANK, 15 foot on spool..	.09
100-ASST. CONDENSERS, .001 to .02	3.95
100-ASSORTED 1/2W. RESISTORS..	1.50
TOGGLE SWITCHES, SPST.....	.14
TOGGLE SWITCHES, DPST .22 DPDT	.29
VOL. CONTROL, 50K ohms w/switch..	.29
PHONO AMPLIFIER, with 3 tubes...	3.95
G.I. PHONO MOTOR, Dual speed...	4.95
ASTATIC PICK-UP, LP type.....	3.75
MAGNETIC PICK-UP, with crystal...	1.39
WEBSTER CRYSTAL, fits most arms..	1.45
NEEDLE CUP, with spring cover....	.02
METAL MESH GRILL, 4"x5 7/8".....	.06
PILOT LIGHTS, #49.....	.02
PLUGS, #PL-54.....	.05
VACUUM TUBE CAPACITOR, 50mmfd	1.95
VACUUM TUBE CAPACITOR, 25mmfd	1.75
DYNAMOTOR, input 2.8V, output 360V	1.50
100-LOCTAL MOLDED SOCKETS...	2.95
AMPHENOL CONNECTORS, #PF 78	.09
AMPHENOL CONNECTORS, #PM 78	.09
PM SPEAKER, 3 inch, square.....	.84
PM SPEAKER, 4 inch, square.....	.97
PM SPEAKER, 5 inch, round.....	1.07
PM SPEAKER, 6 inch, round or square.	1.29
PM SPEAKER, 6"x4" oval.....	1.29
OUTPUT TRANSFORMER, push pull..	.37
OUTPUT TRANSFORMER, universal...	.79
TWIN LEAD-IN, 300 ohm, 100 feet...	1.95
COAXIAL CABLE, 72 ohms, 100 feet..	5.25

UNBRANDED TUBES, all fully guaranteed
1R5—1U5—6AH6—6BA6—354...ea. .34

TUBE CARTONS

100—SMALL PEANUT, 1"x1"x2 1/8"...	\$.75
100—LARGE PEANUT, 1"x1"x2 3/4"...	.85
100—GT TYPE, 1/4"x1 1/4"x3 3/8".....	.95
100—SMALL G, 1/2"x1 1/2"x4 1/2".....	1.25
100—LARGE G, 2"x2"x5".....	1.45

10% Deposit with order, balance C.O.D.
Add Postage

BROOKS RADIO DIST. CORP.
80 VESEY ST., DEPT. A, NEW YORK 7, N. Y.

Stuart Hall Frank has been elected president of MAJOR TELEVISION CORPORATION of New York. He was formerly president of Steinhardt & Kelly. Other officers elected are Irving Ross, vice-president and sales director; Michel E. Macksoud, vice-president and chief engineer; Warren Kessler, vice-president; Henry Weintraub, treasurer; and Charles J. Hyman, secretary.

H. G. Kronenwetter, former advertising production manager of the Radio Division, has been appointed manager of advertising production for the Lighting, Fixture, Lamp, Radio, Electronics, and International Divisions of SYLVANIA ELECTRIC PRODUCTS, INC., according to an announcement by Terry P. Cunningham, director of advertising.



O. K. Lindley has been appointed assistant sales manager, communications products, for the Specialty Division of the GENERAL ELECTRIC COMPANY at Electronics Park, Syracuse, N. Y., according to an announcement by H. W. Bennett, manager of sales for the division. He will be responsible for those communications products designed for other than home use, such as the FM bus receiver equipment and the single side-band selector.



Charles P. Baxter has been appointed assistant general manager of the RCA VICTOR Home Instrument Department of Camden, N. J. He will assist Mr. Henry G. Baker, general manager of the department, in the administration of sales, engineering, design, purchasing, and manufacturing operations.

Mortimer W. Loewi, executive assistant to Dr. Allen B. Du Mont, assumed directorship of the DU MONT TELEVISION NETWORK. He replaces Lawrence Phillips who is leaving Du Mont to operate his own management consultant business. Mr. Loewi has been active in the development of Allen B. Du Mont Laboratories, Inc., since the company's inception.

Dr. Hans Kohler, formerly a member of the Research Laboratories of the Signal Corps, has been appointed to the staff of the NATIONAL BUREAU OF STANDARDS, where he will do theoretical work in the Electronics Division.

G. W. DeSousa has been appointed staff assistant to J. M. Lang, divisions manager of the GENERAL ELECTRIC COMPANY's Tube Divisions at Schenectady, N. Y.

BEST BUYS--KITS--PARTS--ACCESSORIES

DESK HANDSET HANGER



Designed to fit all type handsets equipped with butterfly switch such as TS-9, 11, 13, etc. Circuit opening switch operates when handset is returned into place. Switch contact ratings, 5a, 110v. Handset by Finisher Lip Black Crackle ONLY \$5.95 ea. LIMITED QUANTITY.

HANDSET HANGER



Accommodates all makes and models (W.E. Kellogg, American, etc.) handsets such as TS-9, 11, 13, etc. Fastens to side of desk or on telephone or radio equipment. Black crackle finish. ONLY \$1.95 ea.

REAL BARGAIN!

118-16 HEADPHONES with standard long cord (6 ft.) and adjustable headband. Inquire promptly the best buy in surplus phones ever sold. Tested before shipping. Limited quantity. \$1.35 ea. POSTPAID in U.S.A. and Canada.



NEED 866 TUBES?

Then you will be interested in our large shipment of BRAND NEW 866 Tubes, just received. The 866 has same base connections and very similar ratings to 860. It is vacuum characteristics eliminate hash trouble common to 866, and for this reason, the Navy used large quantities of 866's in much of their equipment. Typical characteristics: Filament -2.5v. @ 5a. Plate current (average) 500ma. for 2 tubes Inverse peak voltage per tube, 5,000 volts. Internal voltage drop similar to 860. OUR PRICE IS THE SCOOP OF THE YEAR! 2 for \$1.10. Be sure to get yours while quantity lasts!

6L6G tubes. New. A buy at 79c ea. 4 for \$3.00. 8012 VNF Triodes. Max. rating to 500mc. \$1.50 ea. or 4 for \$5.00. WE 717A Pentode. High transconductance of 4,000 makes this tube "a natural" for increasing the gain of your present receiver. Directly interchangeable with 6SK7. New. 98c ea. or 4 for \$3.25. 810 Power triodes. 575 watts output to 30 mcl New. ONLY \$5.95 ea. or 4 for \$21.95.

ONLY \$12.95 POSTPAID

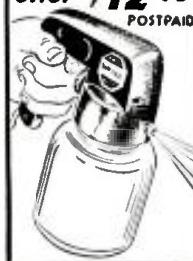

Brand new ELECTRIC PAINT SPRAYER

Just plug it into any 110v. AC outlet and spray. No compressor or other bulky equipment needed. This improved model has moulded bakelite head with trigger control and nozzle adj. Sprays lacquer, enamel, varnish, disinfectants, insecticides, light oils, etc. Perfect for all radio and household uses. Ordinar-Mason jars can be used. Burgess Vibro-sprayer with instructions, extra orifices and jar, ONLY \$12.95 POSTPAID in U.S.A. and Canada.

All merchandise subject to prior sale. 20% deposit must accompany all orders. Balance C.O.D.

OFFENBACH & REIMUS CO.

Dept. E, 372 Ellis St., San Francisco, Calif.

TUBES! TUBES! TUBES!

NATIONALLY ADVERTISED BRANDS

BRAND NEW! BRAND NEW!

TYPE	PRICE	TYPE	PRICE	TYPE	PRICE
O24	\$.55	6AT6	\$.69	12J5	\$.49
12AT7	1.49	6AU6	.69	12K6Y	.89
183GT	1.49	6BA6	.69	12SA7	.85
1D5GT	1.29	6BG6G	1.89	12SJ7	.55
1D7G	1.19	6C4	.29	12SK7	.49
155GT	.69	6D6	.49	12SQ7	.49
1LC6	.99	6F6GT	.49	1447	.55
1LD5	.99	6GG6	.95	1486	.55
1LNS	.69	6H6	.49	14Q7	.55
1N5GT	.69	6J5GT	.49	25L6	.59
1R5	.69	6J6	.69	25Z5	.49
1S4	.69	6L6GA	1.09	25Z6	.49
1S5	.69	6SA7GT	.45	30	.39
1T4	.69	6SD7GT	.45	34	.39
30L6	.69	6SK7GT	.45	35A5	.55
3Q5GT	.69	6SL7GT	.79	35L6	.55
354	.69	6SN7GT	.69	45W4	.45
3T4	.69	6SQ7GT	.45	35Y4	.49
3U4	.69	6SH7	.39	35Z3	.69
3V4	.69	6SS7	.59	35Z5	.40
3X4	.69	6ST7	.79	39 44	.39
5Y3GT	.69	6U5 6G5	.69	50A5	.55
6A6	.69	6V6	.69	50B5	.55
6A7	.69	6X5	.69	50L6	.55
6AC7	.79	6Y6G	.79	57	.39
6AD7G	.99	7A8	.29	80	.42
6AG5	.69	12A6	.29	80	.42
6AK6	.69	12AT6	.49	11Z6	.69
6AL5	.79	12BA6	.59		
6AQ5	.79	12BE6	.59		

WRITE FOR COMPLETE NEW CATALOG
MINIMUM ORDER \$3.00

ALL PRICES F.O.B. N.Y.C.
ON COD ORDER 25% DEPOSIT

THE ROSE COMPANY

98 Park Place, Dept. E, New York 7, N. Y.

L. S. Thees has been appointed general sales manager of the RCA Tube Department, it has been announced by L. W. Teegarden, vice-president in charge



of technical products, RCA Victor Division, Harrison, N. J., of the RADIO CORPORATION OF AMERICA.

Formerly manager of equipment sales of the RCA Tube Department, Mr. Thees will now

coordinate and direct all the sales activities of the department, including equipment and renewal sales. Products of the Tube Department include tubes, electronic components, tube parts and machinery, batteries, test equipment, and accessories.

Charles Roberts has been appointed advertising and promotion manager of AIR KING PRODUCTS COMPANY, INC., of Brooklyn, makers of radio, television, and electronic apparatus. Mr. Roberts was formerly sales promotion manager of Zenith Radio Corporation of New York.

Henry P. Kalmus, formerly a member of the research laboratory of the Zenith Radio Corporation, has been appointed to the staff of the NATIONAL BUREAU OF STANDARDS. Mr. Kalmus will conduct investigations in advanced electronic techniques in the Bureau's Ordnance Research Laboratory.

Dr. B. H. Alexander, formerly professor of metallurgy at the Carnegie Institute of Technology, has joined the staff of the Metallurgical Research Laboratories of SYLVANIA ELECTRIC PRODUCTS, INC., Bayside, N. Y.

Dr. Alexander will head a group of scientists engaged in fundamental studies of the physics of metals, aimed at gaining a better understanding of the basic principles governing the behavior of these materials. Among the elements of interest are tungsten, germanium, titanium, nickel, cobalt, and many others which are important to the performance of radio and electronic tubes and incandescent and fluorescent lamps.



Dr. J. R. Dedrick, formerly associate professor of powder metallurgy at the University of Cincinnati, has been appointed section head of the advanced development group at the metallurgical research laboratories of SYLVANIA ELECTRIC PRODUCTS, INC., according to an announcement by W. E. Kingston, manager of the laboratories. Dr. Dedrick will have charge of the group doing work of a research nature but dealing with problems important to commercial products.

TUBES! NATIONALLY ADVERTISED BRANDS TUBES!

RCA — Kenrad — Sylvania — Tung-Sol — National Union — Raytheon — Philco — Hytron
All new tubes. 100% guaranteed. Individually boxed.

TYPE	PRICE	TYPE	PRICE	TYPE	PRICE	TYPE	PRICE	TYPE	PRICE
0A4G	\$.096	3A4	\$.072	6K6GT	\$.51	6Y7G	1.15	12BE6	\$.65
01A	\$.60	3B7 (291)	\$.96	6K7G	\$.60	6Z7G	1.40	12C8	1.15
0Z4	\$.80	3D6 (299)	\$.96	6K8	\$.85	6ZY5G	1.40	12M8	1.15
1A3	\$.80	3Q4	\$.80	6L5G	\$.96	7A4	1.40	12J5GT	\$.54
1A4P	1.40	3Q5GT	\$.85	6L6	1.26	7A5	1.40	12J7GT	\$.72
1A5GT	1.65	3S4	\$.72	6L6GA	1.15	7A6	1.40	12K8	1.15
1A6	1.15	3R4GY	1.15	6L7	1.15	7A7	1.40	12K7GT	\$.60
1A7GT	1.40	3T4	1.40	6N7	1.15	7A8	1.40	12Q7GT	\$.65
1B4P	1.40	5U4G	\$.54	6P5GT	\$.80	7B4	1.40	12SA7GT	\$.65
1B5 25S	1.15	5V4G	\$.85	6Q7	1.40	7B5	1.40	12SC7	1.40
1C5GT	1.40	5W4	\$.96	6R7	1.40	7B6	1.40	12SF5	1.40
1C6	1.15	5X4G	\$.65	6R7GT	1.40	7B7	1.40	12SF7	1.40
1C7	1.15	5Y3GT	\$.45	6S7	1.40	7B8	1.40	12SG7	1.40
1D5GP	1.15	5Y4G	\$.54	6SA7GT	1.40	7C5	1.40	12SH7	1.40
1D7G	1.15	5Z3	1.15	6SB7	1.40	7C6	1.40	12SJ7	1.40
1D8GP	1.40	5Z4	1.40	6SB7-Y	1.40	7C7	1.40	12SK7GT	1.40
1E5GP	1.40	6A3	1.40	6SC7	1.40	7E6	1.40	12SL7GT	1.40
1E7GT	1.40	6A4/LA	1.15	6SD7GT	1.40	7E7	1.40	12SN7GT	1.40
1F4	1.40	6A6	1.40	6SE5	1.40	7F7	1.40	12SQ7GT	1.40
1F5G	1.40	6A7	1.40	6SF7	1.40	7F8	1.40	12SR7	1.40
1G4	1.40	6ABGT	1.40	6SG7	1.40	7G7	1.40	12Z3	1.40
1G6GT	1.40	6AB7	1.15	6SH7	1.40	7H7	1.40	12Z5 (GZ5)	1.15
1H4G	1.40	6AC7	1.40	6S17	1.40	7J7	1.40	14A4	1.40
1H5GT	1.40	6AD7G	1.15	6SK7GT	1.40	7L7	1.40	14A7	1.40
1H6G	1.15	6AF6G	1.40	6SL7GT	1.40	7N7	1.40	14C7	1.40
1J6G	1.40	6AG5	1.25	6SN7GT	1.40	7Q7	1.40	14F7	1.40
1L4	1.40	6AG7	1.15	6SO7	1.40	7V7	1.40	14H7	1.40
1LA4	1.40	6AK5	1.25	6SR7	1.40	7W7	1.40	14J7	1.40
1LA6	1.40	6AL5	1.25	6S7	1.40	7X7	1.40	14N7	1.40
1LB4	1.40	6AL7	1.40	6S7T	1.40	(XXFM)	1.40	14Q7	1.40
1LC5	1.40	6AQ7	1.40	6SV7	1.40	7Y4	1.40	14R7	1.40
1LD5	1.40	6AT6	1.40	6T7G	1.40	7Z4	1.40	14W7	1.40
1LG5	1.40	6B4G	1.40	6U5	1.40	7Z10	1.40	19	1.40
1LE3	1.40	6B7	1.15	6U6	1.40	12A	1.40	22	1.40
1LH4	1.40	6B8G	1.40	6U7	1.40	12A5	1.40	24A	1.40
1LN5	1.40	6C4	1.40	6V6	1.40	12A6	1.40	25L6GT	1.40
1NSGT	1.40	6C5	1.40	6V6GT	1.40	12A7	1.40	25Z5	1.40
1PSGT	1.40	6C6	1.40	6V7G	1.40	12A8	1.40	25Z6GT	1.40
1Q5GT	1.40	6C8G	1.15	6W7G	1.40	12AH7GT	1.40	26	1.40
1R4	1.40	6D6	1.40	6X3GT	1.40	12AT6	1.40	27	1.40
1R5	1.40	6E5	1.40	6Y6G	1.40	12BA6	1.40	28D7	1.40
1S4	1.40	6F5GT	1.40					30	1.40
1S5	1.40	6F6	1.40					31	1.40
1T4	1.40	6F6G	1.40					32	1.40
1T5GT	1.40	6F7	1.40					32L7GT	1.40
1V	1.40	6F8G	1.40					33	1.40
2A3	1.15	6G6G	1.40					34	1.40
2A4G	1.15	6H6GT	1.40					35	1.40
2A5	1.40	6J5GT	1.40					35A5	1.40
2A6	1.40	6J6GT	1.40					35B5	1.40
2B7	1.40	6J6	1.25					35L6GT	1.40
2X2	1.15	6J7	1.40					35W4	1.40

TERMS: 25% with Order
—Balance C. O. D.—F. O. B.
Chicago. Prices Subject
to Change Without Notice.
Minimum Order \$2.00.

FRANKLIN-ELLIS CO. 1313 West Randolph Street
Dept. RE-5 Chicago 7, Illinois

ARE YOU RECTIFIER-WISE? WIN A VALUABLE PRIZE

With your Circuit Designs Using Federal's
Miniature Selenium Rectifiers





CONTEST DETAILS

- All entries must be original circuits.
- All entries become the property of Federal Telephone and Radio Corporation.
- Federal engineers will judge entries on basis of novel and useful applications and select winning circuits.
- Five winners will be selected from the entries received during each month of the contest. A grand prize will be awarded to the outstanding entry of the contest.
- All entries for this month's judging must be received by May 31. Next month's entries must be received by June 30. Final month's entries must be received by July 31. Contest closes July 31.
- Winners will be announced.

FIVE MONTHLY PRIZES AND A GRAND PRIZE

The five monthly winners will each receive, FREE, a Federal FTR-1342-A5 Selenium Rectifier Power Supply-Battery Charger. This compact unit, with its 6-volt, 6-ampere DC output, has many uses in home and shop. It comes equipped with a handy under-dash mounting socket for automobile battery charging.



The grand prize, a Federal FTR-3246-B5 Radio Service Power Supply, is invaluable as a source of heavy duty, filtered DC power. Its 6-volt, 10-ampere DC output will handle auto radio testing and many other test and permanent power requirements. List price \$74.50.



MAIL YOUR ENTRY TO: MINIATURE RECTIFIER CONTEST
Federal Telephone and Radio Corporation
SELENIUM INTELIN DIV. • 900 PASSAIC AVENUE • EAST NEWARK, NEW JERSEY

NOW...

ONE MAN ALONE



CAN ORIENT A TV ANTENNA QUICKER and BETTER!



with the New
SIMPSON
TV
Antenna Compass

Simpson Model 351 is a ruggedly built pocket size meter which connects to the video input of the cathode ray tube in a television receiver. By an extension cord it is carried to the antenna site. With a test pattern tuned in on the area's weakest station, the antenna is simply rotated for maximum deflection of the TV Antenna Compass! Identifies ghosts, too. Much more accurate than the old-fashioned method—and *one man does it in one-third the time two men used to take!* Dealer's net price only \$16.35. Your Parts Jobber has them NOW.

Simpson
INSTRUMENTS THAT STAY ACCURATE

SIMPSON ELECTRIC COMPANY
5200-18 WEST KINZIE STREET
CHICAGO 44, ILLINOIS

In Canada:
Bac-Simpson Ltd., London, Ontario

... DETROLA CHANGERS

Sometimes these record changers stop after completing half of the change cycle. Replacement of the faulty spring drive belt with a similar one is not effective because the spring soon stretches. Instead, use a rubber belt, such as General Cement's No. 20 Phono Drive.

JOHN STROLE,
Weehawken, N. J.

... AIR KING MODEL 4705

If a set is noisy, has excessive hum, and crackles when the cabinet is tapped, check the points where ground connections are made to the chassis. Very often the soldering may not be perfect and the connections develop a high resistance. The cure is to connect all these points together with hookup wire.

ANTON E. SPERLING,
Ft. Meade, Md.

... INTERMITTENT PORTABLES

In areas where line voltage varies from 115 to 90 volts, portable sets which are intermittent when operated on a.c. can usually be cleared up by replacing either the oscillator tube, the rectifier, or the power-supply filter capacitors. An autotransformer is very useful in determining whether low line voltage is really the cause of the trouble.

THOMAS D. BICHLER,
Tucson, Ariz.

... SILVERTONE 4566

If the set is dead from approximately 750 kc up, check for an open .0041- μ f capacitor between oscillator trimmer and ground. Replace it with a .005- μ f unit.

HURLEY D. ROBINSON,
Pullman, W. Va.

... TUNABLE HUM

When tunable hum is found in a.c.-d.c. receivers, try adding a 0.1- μ f capacitor in parallel with the one across the power line.

ALAN SMITH,
Shaftsbury, Vt.

... SCRATCHY TUNING

If cleaning a tuning capacitor does not clear up the scratchy sound heard when tuning, the shaft may not be making good contact with the frame. Remove the bearing and shaft and clean with carbon tetrachloride. Lubricate with graphite.

A. G. SANDERS,
Miami, Fla.



"What! Another Soap Opera?"

Suggested by J. F. Dunnett,
Vancouver, B.C., Canada

COLUMBIA Gem of the Surplus!

BIGGEST SCOOP IN RADIO!

For month of May only

ATA & ARC-5 TRANSMITTERS

Complete with tubes, crystals; 4—5.3 Mcs.,
5.3—7 Mcs. Used, excellent condition.
Ea. \$2.99

ASB RECEIVER

Complete with lighthouse tubes in R.F.
sections. Ideal for citizens' bands. Used
but excellent condition. Ea. \$17.95
NOTE: Brand new sets also are available.

GO-9 HIGH FREQUENCY TRANSMITTER

Frequency range 300 to 600 Kc—3,000 to
18,100 Kc. No plug-in coils needed. Manual
band switching system. Power output:
125 watts. Has very stable E.C.O. Ready
as is to go on the air—no changes nec-
essary. It's hot on 20, 40 and 80 meter
bands. Extra! We'll supply a technical
manual with first 25 sets sold! External
power supply necessary. Used, excellent
condition. Rock-bottom low price: \$67.95

METERS! METERS!

De Jur, 3" square, O—800 MA. Ea. \$2.95
Roller-Smith, 3" round, O—15VAC.
Ea. \$2.95
Simpson, 3" round, O—120 R.F. MA.
Ea. \$3.49

All top quality! All BRAND NEW!

TUBES!

803. Boxed and BRAND NEW!
Ea. \$4.95

TUBES!

5CP1—5FP7. Boxed,
BRAND NEW!
Ea. \$1.50

APN-1 ALTIMETER

420 MC FM TRANSCEIVER

With tubes and dynamotor. Used but in
good condition. Ea. \$4.95

All prices F.O.B. Los Angeles. 25% deposit
with order. Balance C.O.D.

HEY FELLAS: Send for our new, FREE
catalogue! COME IN and see with your
own eyes the LARGEST SURPLUS ELEC-
TRONICS WAREHOUSE ON THE WEST
COAST!

COLUMBIA ELECTRONICS

Department R-C

522-524 South San Pedro Street
Los Angeles 13, California

AMSCO SERVICE KIT

Kit includes assortment of:

1 lip mike.	10 Wire Wound Resistors.
100 Resistors, 1/2 and 1-	10 & 25 watt.
watt.	25 Connectors, Plugs, Ties.
100 Condensers, paper,	10 Jacks (Phone) & Tip.
mica, electrolytic &	12 Padder Condensers.
can.	12 Terminal Boards.
10 Switches, Toggle, Gang	25 Ceramic Insulators.
& Rotary.	2 Panel Lights (1 neon).
100 ft. Spaghetti, various	1 Screw Driver.
sizes.	1 Tube Puller.
12 Knobs, round and bar.	2 Allen Wrenches.
2 lbs. Hookup wire.	2 Panel Fuse Holders.
20 Fuses.	4 Binding Post Strips, and
6 Volume Controls.	many other valuable
10 Tube Sockets.	items.
1 lb. Hardware (Screws,	
nuts, lugs, etc.).	

Bought individually would cost
\$86.00—Now! Yours for only **\$8.95** Complete

When This Add is
Sent in with Order

Available 1949 CATALOG Write Today

AMERICAN SALES CO.
1811 W. 47th St. Chicago 9, Ill.

RADIO-ELECTRONICS for

RADIO-CONTROLLED AIRCRAFT

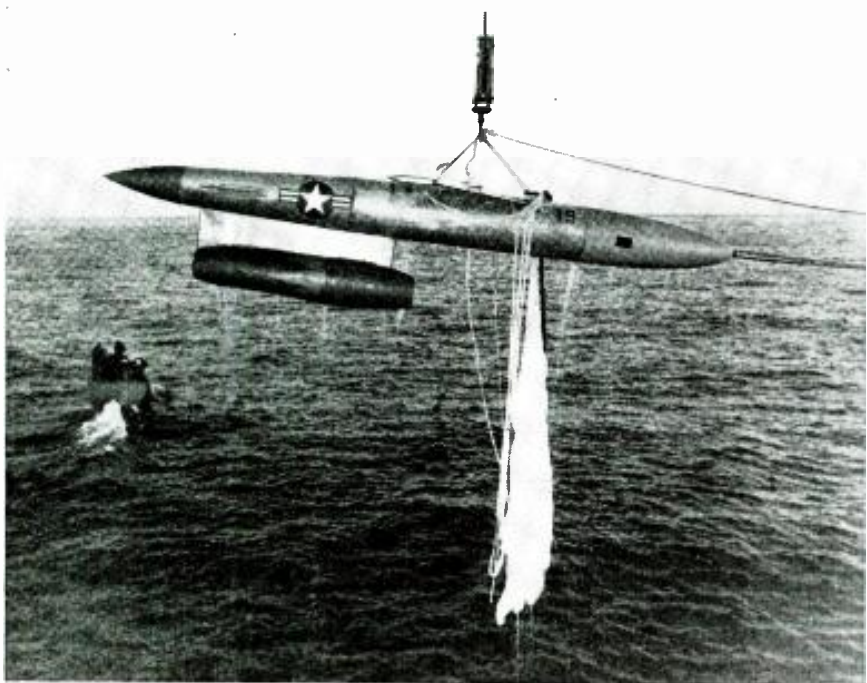

(U.S. Navy photo)

U.S. Navy's newest aircraft used for testing ram-jet engines, the PV-N-2 (Gorgon IV), is radio-controlled. Photo shows craft being taken from water after the end of a test flight. The craft may be controlled completely by radio while in flight; after the fuel runs out a parachute is released and the Gorgon floats down to the water. It is retrieved by a crane

"KIT OF THE YEAR"—LEOTONE'S HIMRO RADIO PARTS KIT "NEVER" BETTER BUY MOST FOR MY MONEY! says Radioman James E. Riley of West Chester, Pa. That's what they're all saying about this giant assortment of new & dismantled Radio & Electronic parts—17 FT.LL POINTS OF COILS, SOCKETS, TRANSFORMERS, SPEAKERS, ACCESSORIES, HARDWARE, WIRE, RESISTORS, CONDENSERS, CONDENSERS, ETC., ETC. ALL THESE (Slipp. wt. 21 lbs.) and MORE ONLY \$2.95



HIGH FIDELITY CRYSTAL MICROPHONES—Sensitive high impedance diaphragm type. Small size (1 1/2" O. D., 3/4") ideal for REGULAR, LAPEL or CONTACT MIKE. Rubber shock-mtd. metal frame. Less housing. NOW ONLY \$98c. Lightweight ALUMINUM HOUSING for above mike \$0.15

SAVE TIME!! ... SAVE MONEY!! REPAIR YOUR OWN SPEAKERS WITH THESE PROFESSIONAL KITS! SPEAKER REPAIR KIT—a really "BIG" kit—Worth many times its price in savings & convenience. Contains: 25 assist. mtg. rings, 10 spiders, 25 voice coil forms, 3 vcls. tel. strip, 20 chamois leather segments, kit of 16 shims, tube speaker cement. WITH INSTRUCTIONS. Shpg. wt. 5 lbs. \$2.49 ONLY

SPEAKER CONE KIT—A LEOTONE SPECIAL! SINCE 1927! Handy assortment of 1" to 12" top quality moulded & trevored cones (magnetic incl.). Less voice coils. KIT OF 12 ONLY \$2.00 SPECIAL BARGAIN OFFER!!—BOTH "REPAIR & CONE KITS" FOR ONLY \$3.95

HEARING AID PARTS Famous make miniature units for use where space is limited. MIDGET OUTPUT TRANSFORMERS (1 1/2"x1 1/2", 3/4") One of the smallest made. High imped. to voice coil. For Personal or Portable sets. Intercoms, etc. \$0.49 MIDGET AUDIO CHOKES (1 1/2"x3/4", 3/4")—1500 ohms 10". Used in Filter Circuits. Impedance coupling, etc. \$0.49 BONE CONDUCTION RECEIVER (1 1/2"x3/4", 3/4")—Sensitive moving armature type. Makes excellent MUSICAL CONTACT MIKE; MINIATURE or PILLOW SPEAKER. Low imped. ea \$2.95. 1 for \$9.95 Write today for FREE SUPPLEMENTS on RECORDING, MINIATURE HEAR AID PARTS, ALNICO MAGNETS, RADIO-ELECTRONIC SUPPLIES

Min. order \$2.00. 20% Deposit Req. on all C.O.D.'s. Please add sufficient postage—excess refunded.

LEOTONE RADIO CO. 67 Dey Street, New York 7, N. Y.

FREQ MULT UNIT



ART-13 Xmfr Assy. 2 to 18 Mc. Doubling Package setup, for two 1025 Tubes. No coils. Complete Assy. Less Tubes w ckt Diagram. Price \$9.95 UTC #60399—Audio Xfrmr 1:1 Ratio, 50,000 ohm imp. 3 db. ± 1 db. 50-3000 cv. OUNCER. Price 98c ARC 9466—Mod. Xfrmr 807 to Par. 807B Class "A" Price \$1.65

UNIVERSAL OUTPUT XFRMR—Ampl. Selctcr. Pri. 2000V/18000 5000 4000 ohms. Sec. 500 15 7.5 7.5 3.75 1.25 0.625 3 ch. Flat to 17000 cy. Price \$4.75 MOD INPUT XFRMR-T202, 6V6 P1 to 811 Grids for ART 13. \$17.200. Price \$3.49 SEND FOR LISTS OF AUDIO EQUIPMENT

PRECISION RESISTORS

Table of precision resistors with columns for value, tolerance, and price. Values range from 1.01 to 20000 ohms.

OTHER VALUES IN STOCK. SEND FOR LIST

TRANSFORMERS AND CHOKES



Table of transformers and chokes with columns for specifications (e.g., 2.5VCT 6.5A) and price. Includes details like primary/secondary voltages and currents.

SEND FOR LISTS OF TRANS. & CHOKES

3" OSCILLOSCOPE

BC 929 Indicator using 9 Tubes, 3BP1, 6SN7, 6HG, 6BG6, 6X5, 2X2 (now 400 cycles) easily conv. to 60CY. 115V. See complete w/Tubes and converter. Instr. Inc. Dia. \$24.95



5" OSCILLOSCOPE

BC 704 (less pwr. supply) uses 8 Tubes—5BP1, 6AC7, 6HG, includes Wooden Case and Schematic Diagram. Price \$32.50 3BP1... \$2.25 5CP1... \$3.75 3DP1... 2.25 5FP7... 3.50 5BP1... 1.95 2X2... .69 5BP4... 4.95 6L6GA... 1.00

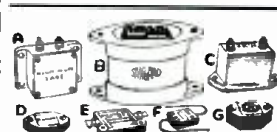

H. V. MICAS SEND FOR LISTS OF OTHERS

Table of vacuum tube prices with columns for figure number, manufacturer (Mfg.), and price. Lists various tube types like 1200WVDC, 2500VDC, etc.

932 PHOTO TUBE

This Tube is a Gas Phototube having S-1 Response, particularly sensitive to Red and Near Infrared Radiation. Can be used with incandescent light sources. Send for Data. Price... \$3.25



BATHTUB CAPACITORS

Table of bathtub capacitor specifications with columns for figure number, manufacturer (Mfd.), voltage, terminals, and price. Lists various capacitor types and values.

WRITE FOR LISTS OF OTHER VALUES

BIRTCHE TUBE CLAMPS

926-A, 926-A2, 926-B, 926-B1, 926-B5, 926-B5A, 926C... @ 12c ea.

\$3.00 MINIMUM ORDER

All merchandise guaranteed. Mail orders promptly filled. All parts. F.O.B. New York City. Send Money Order or Check. Only shipping charges sent C.O.D.

COMMUNICATIONS EQUIPMENT CO.

131 LIBERTY ST., N. Y., 7, N. Y., DEPT. C. PHONE DIGBY 9-4124

\$3.00 MINIMUM ORDER



SERVICE Television AND RADIO WITH THIS MODERN SERVICE UNIT

TELEVISION and FM radio present un-limited opportunity for service PROFIT . . . Your profits and service require the best equipment . . . SER-V-LUX.

*Custom built instruments available for all types of service . . . or, unit can be supplied with blank panel.

Write for bulletin D



SERVELUX
MANUFACTURING CO.
39th and Buchanan Ave.
GRAND RAPIDS, MICH.

FREE



send today for this big book of values in **TELEVISION RADIO, ELECTRONIC, INDUSTRIAL, SOUND & AMATEUR EQUIPMENT**

NEW 1949 NEWARK CATALOG

20,000 items including everything in STANDARD BRAND equipment! 148 pages packed with pictures, charts, and vital information! **KITS! SETS! PARTS! ACCESSORIES!**

No matter how tiny the part, how tremendous the system...it's listed in this mammoth catalog...the one easy, satisfactory way to always get top-performing, top-value equipment! The most complete essential reference book for pros, hams, hobbyists, novices, oldtimers...anyone. everyone interested in TV, radio and sound equipment!

24-HR. MAIL SERVICE • ONE YEAR TO PAY

3 GREAT STORES! Uptown at 115 West 43rd Street and Downtown at 212 Fulton Street in **NEW YORK** 323 West Madison Street in the heart of **CHICAGO**



MAIL COUPON TODAY

Newark Electric Co.
242 W. 55th St., NYC

Dept. E-11 Please send FREE Newark Catalog to:

NAME _____
ADDRESS _____
CITY _____ STATE _____

FUTURE AIR TRAVEL SAFER

Travel by air in 1964 will be at least as safe, reliable and automatic as train travel is today, D. W. Rentzel, U. S. Administrator of Civil Aeronautics told the recent Institute of Radio Engineers convention in New York. According to Mr. Rentzel, the typical flight of 15 years hence will be much like this:

The pilot's landing time will be reserved for him before he leaves his port of departure. A dial on his board will tell him how many minutes or seconds he is ahead or behind schedule, so that he can regulate his speed.

A pictorial presentation of everything around him will appear on a television screen in the cockpit. He will thus be able to see other planes, obstructions, and even storms which are near him.

A railroad-like radar "block system" will assure that he is in safe air space—free from collision danger—at all times.

Telemetering systems will show ground controllers the readings on all the plane's instruments. Any variation from the conditions noted by ground instruments will be noted and warnings flashed to the pilot.

If the pilot wishes to change altitude or flight plan, he will query ground stations by pressing a button, and transmit his new plan to a calculating machine, which will check its practicability and flash approval or disapproval in a fraction of a second.

SWEDES PHOTOGRAPH SUN

Photographs of the sun taken in Sweden and transmitted to this country by radiophoto, whenever the sun is obscured in New York, are making it possible for RCA Communications, Inc., to continue without interruption its daily forecasts of sunspot activity, General H. C. Ingles, president, announced last month. Observations of solar disturbances and the calculation of their effect on shortwave transmission have been carried out by RCA for several years. The information provides advance warning of magnetic storms and permits rerouting of radiotelegraph traffic to circuits outside the areas affected.

Until recently, General Ingles stated, forecasts of radio conditions have depended upon success in "shooting" the sun through a refracting telescope installed atop the RCA Central Radio Office at 66 Broad Street, New York. But a recent prolonged cloudy period revealed the need for a supplementary source of data in emergencies, and led to the present cooperative arrangement with the Royal Board of Swedish Telegraphs in Stockholm and the Stockholm Observatory in Saltsjobegen, Sweden. When observation by RCA in New York is impossible, a photograph of the sun, taken by Dr. Yngve Oehman, in charge of solar work at the Stockholm Observatory, is transmitted to New York by radiophoto to take the place of the local observation.

HARD-TO-GET PARTS

POWERFUL ALL-PURPOSE INDUCTION MOTOR

IDEAL FOR EXPERIMENTERS—101 USES



Sturdily constructed to precision standards, this self-starting shaded pole A.C. induction motor is powerful enough for a number of uses. Some of these are: Automatic Timing Devices, Current Interrupters, Electric Fans, Electric Chimes, Window Displays, Protocol Control Devices, Electric Vibrators, Small Grinders, Buffers and Polishers, Miniature Pumps, Mechanical Models, Sirens, and other applications.

Consumes about 15 watts of power and has a speed of 3,000 r.p.m. When geared down, this sturdy unit will constantly operate an 18-inch turntable loaded

with 200 lbs. dead weight—THAT'S POWER!
Dimensions 3" high by 1 3/4" deep; has a convenient mounting stud; shaft is 7/8" long by 3/16" diameter, and runs in self-aligning oil-retaining bearings. Designed for 110-220 volts, 50-60 cycles, A.C. only. Shp. Wt. 2 lbs.

ITEM NO. 147
YOUR PRICE \$1.95

ULTRA MAGNET

LIFTS MORE THAN 20 TIMES ITS OWN WEIGHT

LITTLE GIANT MAGNET

Lifts 5 lbs. easily. Weighs 4 oz. Made of ALNICO new high-magnetic steel. Complete with keeper. World's most powerful magnet ever made. The experimenter and hobbyist will find hundreds of excellent uses for this high quality permanent magnet. Measures 1 3/4" x 1 1/2". Shp. Wt. 2 1/2 lbs.

ITEM NO. 158
YOUR PRICE \$1.25

GENUINE MICROPHONE TRANSMITTERS

Regular telephone transmitters (taken from a large telephone supply company's overstock). Work perfectly on 2 wire, central office type, used on P.A. systems, call systems, inter-communication systems, etc. Can be used through your own radio or as concealed dictaphone pick-up. Useful replacement on battery-operated rural telephone lines.

THESE ARE GENUINE KELLOGG WESTERN ELECTRIC AND STROMBERG CARLSON, excellent in appearance and operation. A remarkable value and one seldom offered in these quantities. Shp. Wt. 1 lb.

ITEM NO. 160
YOUR PRICE \$1.95

WATT HOUR METER

Completely overhauled and ready for immediate service. Designed for regular 110 volt, 60 cycle 2-wire A.C. circuit. Simple to install: 2 wires from the line and 2 wires to the load. Sturdily constructed in heavy metal case, 8 1/2" high, 8 1/4" wide, 5 1/2" deep. Westinghouse, G. E. Fort Wayne, Sangamo or other available make. Shp. Wt. 1 1/2 lbs.

ITEM NO. 33
YOUR PRICE \$5.95

AMAZING BLACK LIGHT!!

Powerful 250-Watt Ultra-Violet Source



The best and most practical source of ultra-violet light for general experimental and entertainment use. Makes all fluorescent substances brilliantly luminescent. No transformers of any kind needed. Fits any standard lamp socket. Brings out beautiful unaltered hues in various types of materials. Great for amateur parties, plays, etc.; to obtain unique lighting effects. Bulb 1 1/2" dia. Shp. Wt. 2 lbs.

ITEM NO. 87
YOUR PRICE \$1.95

WESTERN ELECTRIC BREAST MIKE

This is a fine light-weight aircraft carbon microphone. It weighs only 1 lb.

Mike comes with breastplate mounting and has 2-way swivel adjustment so that it can be adjusted to any desired position. There are 2 woven straps; one goes around neck, the other around chest. Straps can be snapped on and off quickly by an ingenious arrangement.

This excellent mike can be adapted for home broadcasting or private communication system. Dismounting breastplate. It can be used as desk mike.

Comes complete with 8-foot cord and hard rubber plug. Finished in sherdarized plate. non-rustable. Shipping weight, 2 lbs.

ITEM NO. 152
YOUR PRICE \$1.45



HUDSON SPECIALTIES CO.
40 West Broadway, Dept. RE-5-49, New York 7, N. Y.

I have circled below the numbers of the items I'm ordering. My full remittance of \$ (including shipping charges) is enclosed (NO C.O.D. ORDERS UNLESS ACCOMPANIED WITH A DEPOSIT.)

OR my deposit of \$ is enclosed (20% required). Ship order C.O.D. balance. NO C.O.D. ORDERS FOR LESS THAN \$5.00. BE SURE TO INCLUDE SHIPPING CHARGES.

Circle Item No. wanted:
147 158 160 87 152 33

Name _____
Address _____ Please Print Clearly
City _____ State _____

Thermostatically
CONTROLLED

KWIKHEAT SOLDERING IRON

*VANATTA PATENT



- Heats 3 times Faster
- Maintains Constant Temperature
- Tips stay tinned 10 times longer
- Can't Overheat
- 1/2 Weight of Other Irons
- Air Cooled Handle
- Guaranteed One Year

See your Dealer
If he cannot supply you
write to

KWIKHEAT MANUFACTURING CO.

3732 SAN FERNANDO RD.
GLENDALE 4, CALIFORNIA

Radio Thirty-Five Years Ago
In Gernsback Publications

HUGO GERNSBACK

Founder

Modern Electrics	1908
Electrical Experimenter	1913
Radio News	1919
Science & Invention	1920
Radio-Craft	1929
Short-Wave Craft	1930
Wireless Association of America	1908

Some of the larger libraries in the country still have copies of ELECTRICAL EXPERIMENTER on file for interested readers.

MAY 1915 ELECTRICAL EXPERIMENTER

- Tuning Coil Sliders, by Edward Minnis
- A Solderless Detector Cup, by Godfrey Rigby
- Wireless Telephony and Telegraphy on Union Pacific, by Frank C. Perkins
- A Novel Detector Stand
- A New Wireless Valve
- A Rotary Switch Tuning Coil
- Variable Condenser Switch, by Max Epstein
- The D. C. Arc for Wireless Telegraphy and Telephony
- Improved Conical Tuning Coil
- Novel Wireless Telephone Microphone
- Universal Crystal Detector, by W. H. Hale
- The Galvanometer as a Radiation Indicator for Radio Transmitters, by William H. Dettman
- A Radio Blocking Condenser, by Percy M. Roope
- A "Wireless" Menu

AT LAST! A LOW COST POWER UNIT

for Service Work

"A" Eliminator Kit #KC 1-10
Including pictorial and schematic diagrams ONLY **\$1950**

These kits fulfill the long-standing need of every serviceman and technician. They are designed to operate from a 115 V.A.C. 50-60 cycle source, and deliver 6 V.D.C. well-filtered from three to eight amperes, with a peak rating of ten amperes. The A.C. ripple percentage is held to remarkably low values.

This unit charges a standard auto battery in one day!!

- Do away with bulky batteries!
- Do away with corroding fumes!
- Simplify your service operation!

Order this fine kit for your bench today!!

No O.D.'s, please. Orders received without sufficient allowances for postage will be shipped via Railway Express collect.

Shipping wt. 12 lbs.

OPAD-GREEN COMPANY
71 Warren St. New York 7, N. Y.
Phone: BEekman 3-7385-6

GOVERNMENT SURPLUS!
WORLD'S LOWEST PRICE

PHOTO FLASH EQUIPMENT

COMES COMPLETE WITH
4 EDGERTON FLASH TUBES & REFLECTORS

EASY TO CONVERT INTO A 2-WAY PHOTO FLASH UNIT
OPERATES ON 110V. AC & 12V. BATTERY

Brand new at a fraction of original cost. Contains finest component parts available. All necessary parts and complete instructions included. After conversion, works on 110V AC or 12V battery by a flick of a switch.

\$68.

WRITE FOR MORE DETAILED INFORMATION. IMMEDIATE DELIVERY COMPLETE

CINEX, INC., 165 W. 46th St., N. Y. 19, N. Y., Dept. RES

BRITONS COMMENT ON BILL

The British government has proposed to solve the problem of man-made r.f. noise by passing a bill making un-suppressed noise sources cause for legal action against the owner. An apt comment, headlined "More Dinned Against than Dinning," is this letter to the *London Times*, quoted in the *Scottish Radio Trade Digest*:

Sir,—What irony if a man is compelled to fit a gadget to suppress an electric fire (electric heater—Ed.) or a water-heater from interfering with the wireless opposite or upstairs which is blaring uninhibited and unashamed!

A. G. MORRIS.

The *Digest* itself had this to say:
A point about the Wireless Telegraphy Bill about which there appears to be considerable feeling is the fact that there is no compulsion on manufacturers of apparatus causing or capable of causing interference with radio, to fit suppressors.

It has been pointed out that a lot of appliances which can cause interference do not in fact do so for several reasons, and secondly that the incorporation of a suppressor raises the cost. . . .

So does the provision of adequate insulation, but no one would argue that an appliance capable of killing the user of it does not necessarily do so.

The fact is that all new electrical equipment should be suppressed, and manufacturers should be made to produce interference-free products.

TALK ANYWHERE-INSTANTLY TO ANYONE!

WITH INTERCOM

Just push buttons and talk to or from 1 to 7 different places! Not a noisy-loud room volume—no electric "plug-ins" or tubes needed! Set or hang it! Simple and quick to hook up. For homes, offices, stores, farms, etc. Guaranteed! Write for free details today! A unit wanted. As Low As **\$5.97 EACH**

MIDWAY CO., Dept. RE-5, Kearney, Nebr.

LEARN

Electricity OR Radio-Television

IN THE GREAT SHOPS OF **COYNE**

TRAIN QUICKLY!
OLDEST, BEST EQUIPPED SCHOOL OF ITS KIND IN U.S.
2 Opportunity Fields

COYNE 50th ANNIVERSARY

Come to the Great Shops of COYNE in Chicago during our 50th Anniversary Year! Get quick, practical training in RADIO TELEVISION or ELECTRICITY. U. S. Government approved. Finance plan for non-veterans. Mail Coupon Today for complete details.

NOT "HOME-STUDY" COURSES!
You learn on real, full-size equipment, not by mail. Finest staff of trained instructors to help you get ready quickly for a better job, a fine future.

FREE BOOKS—Clip coupon for big illustrated Coyne book on either ELECTRICITY or RADIO-TELEVISION. Both books sent FREE if you wish. No obligation; no salesman will call. Act NOW!

B. W. COOKE, Pres.
COYNE Electrical & Radio School, Dept. 59-3111
500 S. Paulina Street, Chicago 12, Illinois

Send FREE BOOK and full details on:

ELECTRICITY RADIO-TELEVISION

NAME.....

ADDRESS.....

CITY..... STATE.....

TELEPHONE HANDSET HANGER

Now Low Price **\$1.49** Postpaid

Fits most types all market. Made of heavy duty aluminum casting. Excellent for desk, mobile or marine use. BRAND NEW

ALVARADIO, Dept. RC-22
903 S. Alvarado Los Angeles 6, Cal.

ONLY FILMGRAPH

Records Interviews, Conferences, Dictation, Telephone Conversations, AUTOMATICALLY, CONTINUOUSLY and PERMANENTLY at less than 3 per hour.

MILES REPRODUCER CO., INC.
812 Broadway, N. Y. 3, Dept. RC-5

FREE!

for BEST BUYS and
LOWEST PRICES in
RADIO & TELEVISION
PARTS—SETS—ACCESSORIES
Get RADIONIC'S
Bargain Bulletins

TUBES RCA • GE • SYLVANIA
HYTRON • KEN-RAD
NATIONAL UNION • TUNG-SOL • RAYTHEON
Individually boxed Standard RMA Guarantee
5Y3GT, 45c; 6F6GT, 55c; 6SN7GT, 90c; 12SQ7GT,
70c; 25L6GT, 70c; 25Z5, 60c; 35L6GT, 65c; 35Z5GT,
49c; 50L6GT, 65c; 25Z6GT, 60c.

CAVITY RESONATOR



FORTHEUHFBUGS
Here's the best yet in UHF gear! A portable test oscillator designed for the Navy Gold-plated cavity resonator provides frequency range of 231 to 258 mc. Includes 2 1/2" x 1 1/2" ready to go battery compartment to house a small modulator and power supply. It fits out the parts and you have a dandy 1/16" aluminum cabinet. 13 fasteners. **\$3.25**

net (no holes) with handle. Dimensions: 1 1/2" x 1 1/2" x 1 1/2". (10 lots of 3, \$2.95 each)

RADIONIC EQUIPMENT COMPANY

Tribune Theater Entrance
170K Nassau Street New York 7, N. Y.
WOrth 2-0421
Open daily 9-6 • Saturday 9-5

RADIONIC EQUIPMENT COMPANY Dept. 105
170K Nassau St., New York 7, N. Y.

Please rush free copy of latest bulletin of radio and television bargains in parts, tubes, sets and accessories.

Name

Address

City..... State.....

"MULTI-TESTER" MODEL 30



Model 30 (Illustrated) \$15.95 net
Model 30P (Portable) 19.95 net
Model 30K (Complete KIT and Instructions) 13.95 net

SIGNAL GENERATOR MODEL 300



Supplies 456 Kc., 465 Kc., 600 Kc., and 1500 Kc.
Model 300 (Illustrated) \$16.95 net
Write for FREE CATALOG. SEE your local distributor.
If not available, WRITE to:

BRADSHAW INSTRUMENT CO.
42 Flatbush Ave., Dept. RC, Brooklyn 17, N. Y.

THINKS PEDRO MISLEADING

Dear Mr. Shunaman:

This will acknowledge, with my thanks, the return of the negative which pictured one of the simple decommissioning devices used in our survey last year.

I acknowledge, too, the January issue of your publication which contains, on page 54, a story titled "The Impeded Double-Cross."

The article, in my opinion, renders a serious disservice, not only to the honorable element in the radio service industry, but to those legitimate agencies of business with whom they are co-operating to improve the ethical standards of the industry.

The distortions, both of fact and technique, which occur in "The Impeded Double-Cross" may result in some confusion in the minds of your readers. I am sure that the majority of them feel, as we do, that these occasional airings have been good for the industry as a whole, because they have paved the way for the establishment of uniform standards of practice and improved customer relations.

Is it possible that the clamor of the guilty few has made a louder noise in your editorial offices than the resultful efforts of the ethical many who are quietly working to maintain the integrity and dignity of the industry?

G. H. DENNISON
General Manager
Better Business Bureau
of Pittsburgh, Inc.

OUR REPLY

Dear Mr. Dennison:

I am at a loss to understand your reaction to "The Impeded Double Cross." I have re-read the article carefully and failed to find any "distortions" either of fact or technique. I would appreciate your calling to my attention any distortions of fact. I feel myself a competent judge of technique, but would also like to hear any comments from your technical contacts concerning supposed "distortions of technique."

I realized from your rather puzzled

WE PAID \$1.85 TO \$9.50
TO HAVE THESE PRONGS CLOSED.



One of the Pittsburgh BBB's faulty circuits.

Now... In Kit Form!

E.M.C. MODEL 300
VACUUM TUBE
Volt-Ohm-Capacity
METER



\$24.95

- DC VOLTS—6 ranges to 1000 volts!
- AC VOLTS—5 ranges to 1000 volts!
- RESISTANCE—6 ranges to 1000 meg-ohms!
- CAPACITY—4 ranges (.00025 mfd to 20 mfd)
- ZERO CENTER POSITION
- INCLUDES LEADS

Completed Unit \$39.50
CAPACITY RANGE and ZERO CENTER POSITION are features not available in competitive VIVM kits.



EMC Model 120
VOLOMETER

\$22.95

The ONLY 20,000 ohms-per-volt instrument that gives you ...

- 6 D.C. Volt ranges at 20,000 ohms/volt to 6000 volts
 - 6 A.C. Volt ranges at 10,000 ohms/volt to 6000 volts
 - 5 current ranges to 6 amps
 - 4 resistance ranges to 300 megs
- Completed Unit \$29.95

E. M. C. Gives More Measurement Value per Dollar!
ELECTRONIC MEASUREMENT CORP.
423 Broome St., Dept. B-5, New York 13, N. Y.
Write For Free Catalog

RADIO MADE EASY!

A JRI Trainer

A NEW APPROACH to radio receiver repairing. Here is a METHOD of radio repairing that can be LEARNED QUICKLY—Begin repairing immediately. The electronic field is wide open. Prepare yourself for a GOOD INCOME NOW! Discover for yourself that radio repairing is EASY TO LEARN by this NEW METHOD. Send for the JRI Home Trainer TODAY. \$2.00 postpaid or plus e.o.d. charge. Satisfaction guaranteed.

THE JRI TRAINERS
P. O. Box 2091, Dept. 100-E, Chicago 9, Ill.

RADIO-ELECTRONICS prints several radio cartoons every month. Readers are invited to contribute humorous radio ideas which can be used in cartoon form. It is not necessary that you draw a sketch, unless you wish.

earlier letters that you were not quite clear as to our objections to the type of investigation carried out in Pittsburgh, and felt that the story would clear you up. Now I am not sure what the situation is. It seems possible that you either feel that we object to investigations *per se*; or that you feel that the kind of gimmicking described in "The Impeded Double Cross" is a fair test of an auto mechanic's honesty or ability; or that you may have fallen into that error common to all of us in believing that a given method must be all right simply because you used it.

We are not opposed to investigations. What we oppose is investigations carried on with the help of "gimmicks" or artificial, atypical faults which do not fall within the technician's normal experience, and consequently cause him extraordinary amounts of time and labor to discover.

You will remember that I asked you before: why not get radio service technicians to put the receiver into condition for an investigation; put into it genuine defects like broken-down filter capacitors, burned-out coils and shorted bypass capacitors.

I also pointed out—to head off any argument that similar results might follow a genuine, as would be produced by a "gimmicked", investigation—that just such genuine investigation had taken place. It was conducted by the former New York newspaper *PM* with the object of ascertaining what shops they could recommend to readers. A

genuinely faulty radio was found for the test. Before taking it to the first shop, it was examined by a technician, Herbert Roth of the Electronic Corporation of America, who discovered that one section of an electrolytic capacitor was partially open, the set was out of alignment, needed cleaning, and had a burned-out pilot lamp and a line cord broken at the plug. Thus both the gimmick and the almost equally bad trivial complaint were avoided.

The investigation was made in 1946, a wartime shortage year. Yet the highest quotation received was in the order of \$8. Only two of the 10 shops canvassed gave an incorrect diagnosis, and of the ten shops, six were recommended by the paper. The recommendation took into consideration such points as price (highest price by a recommended shop was \$7.10, lowest \$4.75), guarantee, and apparent ability to deliver a good job, as well as honesty.

So you can see that there is a difference between an investigation made with genuine faults and a "gimmicked" one. I mentioned this investigation to you in my letter of May 19, 1948, but you did not refer to it later.

We agree with you that honest, competent investigations might well be "good for the industry as a whole" but have pointed out in articles and editorials that "gimmicked" investigations have harmful features which may neutralize any good done. And it is not the "guilty few" who object strenuously. They would be at as great a disad-

AMPERITE

Studio Microphones at P.A. Prices

**Ideal for
BROADCASTING
RECORDING
PUBLIC ADDRESS**

"The ultimate in microphone quality," says Evan Rushing, sound engineer of the Hotel New Yorker.

- Shout right into the new Amperite Microphone—or stand 2 feet away—reproduction is always perfect.
- Not affected by any climatic conditions.
- Guaranteed to withstand severe "knocking around."

Models
RBLG—200 ohms
RBHG—Hi-imp.
List \$42.00

"Kontak" Mikes
Model SKH, list \$12.00
Model KKH, list \$18.00

Special Offer: Write for Special Introductory Offer, and 4-page illustrated folder.

AMPERITE Company, Inc.
561 BROADWAY • NEW YORK 12, N. Y.
Canada: Atlas Radio Corp., Ltd., 500 King St. W., Toronto



For GREATER Earnings... LEARN RADIO-ELECTRONICS



This fast-growing science of RADIO, TELEVISION, RADAR and ELECTRONICS, offers tremendous opportunities, and in no industry is RADIO-ELECTRONICS more important than in aviation. A skilled technician who *knows* the modern application of electronic devices, as used in the aircraft industry, is always in demand . . . not only in aviation, but in many other industries. Many large organizations call on Spartan regularly for graduates. Often, students are hired months before graduation.

Don't confuse the RADIO-ELECTRONICS course offered by SPARTAN with other courses, offered anywhere! As a graduate from this famous school you will know the application to industrial control devices; to the search for petroleum; and the important uses of radar, television and other electronic equipment.

SPARTAN offers two complete and thorough courses. You will work on the most modern and complete equipment. You will build equipment. You may join the SPARTAN "Ham" Club. Either course prepares you for Federal Communication Commission license tests—first class radio telephone, second class radio telegraph, or class "B" radio amateur.

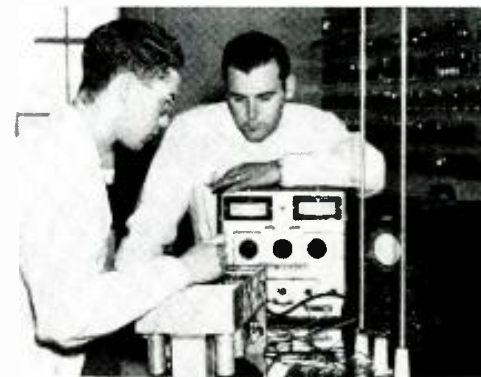

SPARTAN'S 21 years of teaching civilian and army personnel is your assurance of receiving the best possible training in the least possible time. *You'll not need MORE than Spartan training—you cannot afford to take LESS.*

BIG CATALOG—Free

NAME _____ AGE _____

ADDRESS _____

CITY _____ STATE _____

Dept. RE-59

G. I. APPROVED—Write TODAY for Complete Information

SPARTAN

SCHOOL OF RADIO AND ELECTRONICS

SCHOOL of AERONAUTICS
MAXWELL W. BALFOUR, DIRECTOR



COLLEGE of ENGINEERING
ADDRESS DEPT. RE-59

TULSA, OKLAHOMA

RADIO SCHOOL DIRECTORY

SPECIALIZE • SPECIALIZE



You can become a Radio and Television Technician now!

A million new jobs — almost 4,000 a week — will be created in the television industry during the next five years according to estimates of industry leaders. Actually, during 1948, television grew faster than any other industry in the history of America.

Here is a real opportunity for you. Trained television technicians are in demand. By starting now, you can get in on the ground floor — grow as television grows.

To help supply this needed manpower, the Milwaukee School of Engineering has expanded its radio and television courses. Now you can get complete practical, technical training in the MSOE laboratories. *This is not just a serviceman's course.* It prepares you for a career in all of the technical phases of television and radio.

This special course Prepares you for any of the following careers:

- | | | |
|---|---|---|
| Television Serviceman
Radio Serviceman
Radio and Television
Retailer | Supervisor in Radio and
Television Assembly
Radio and Television Tester
Broadcast Radio-Operator | Police, Taxi-Cab and Rail-
road Transmitter Operator
Police, Taxi-Cab and Rail-
road Receiver Serviceman |
|---|---|---|

OTHER COURSES AVAILABLE		
SERVICE 6 to 12 Months	TECHNICIAN 1 to 2 Years	PROFESSIONAL 3 Years
• Electricity	• Electrotechnics	• Electrical Engineering
• Welding	• Radio and Television	• Bachelor of Science Degree
• Refrigeration	• Electronics	• Major in Electronics or Power
• Heating	• Refrigeration, Heating and Air Conditioning	

MILWAUKEE SCHOOL of ENGINEERING



A Technical Institute
Founded 1903
by Oscar Werwith

MILWAUKEE SCHOOL OF ENGINEERING,
N. Broadway and E. State

Dept. RE-549
Milwaukee, Wis.

Without obligation send me free booklet "Career Building" and more details on course in Radio and Television or _____ course.

Name _____ Age _____

Address _____ State _____

City _____

LEARN RADIO!

PREPARE FOR A GOOD JOB!
COMMERCIAL OPERATOR (CODE)
RADIO SERVICEMAN

TELEVISION SERVICING
BROADCAST ENGINEER

Veterans get \$130.00 Equipment

SEND FOR FREE LITERATURE

BALTIMORE TECHNICAL INSTITUTE

1425 Eutaw Place, Dept. C, Baltimore 17, Md.

V RADIO ENGINEERING

FM—Television—Broadcast

Police Radio, Marine Radio, Radio Servicing, Aviation Radio and Ultra High mobile applications. Thorough training in all branches of Radio and Electronics. Modern laboratories and equipment. Old established school. Ample housing facilities. 7 acre campus. Small classes, enrollments limited. Our graduates are in demand. Write for catalog.

Approved for Veterans

VALPARAISO TECHNICAL INSTITUTE
Dept. C VALPARAISO, INDIANA



JOBS IN TELEVISION

YOUNG MEN 16 TO 60

There is a Job Opening for Every Qualified Trained Television Technician

WE CAN TRAIN YOU

Free Employment Service

Visit Our Modern Laboratories and Class Rooms

APPROVED UNDER G.I. BILL OF RIGHTS

AMERICAN RADIO INSTITUTE

New York Buffalo, N. Y. Syracuse, N. Y.
101 W. 63 St. 640 Main St. 131 Shonnard St.

"Teaching Radio Since 1935"

TELEVISION NEW, INTERESTING TECHNICAL CAREER

As Television gains momentum, rapidly, constantly, it offers to properly-trained technicians careers with a future in industry, Broadcasting or own Business.

Train at an Institute that pioneered in TELEVISION TRAINING since 1938.

Morning, Afternoon or Evening Sessions in laboratory and theoretical instruction, under guidance of experts, covering all phases of Radio, Frequency Modulation, Television. Licensed by N. Y. State. Free Placement Service. Approved for Veterans.

ENROLL NOW FOR NEW CLASSES

Visit, Write or Phone

RADIO-TELEVISION INSTITUTE

480 Lexington Ave., N. Y. 17 (46th St.)
Plaza 3-4585 2 blocks from Grand Central



RADIO COURSES

Preparatory Mathematics, Service, Broadcast, Television, Marine Operating, Aeronautical, Frequency Modulation, Radar.

Classes now forming for the Summer term June 15.
Entrance exam. May 16

Veterans. Literature.

COMMERCIAL RADIO INSTITUTE

(Founded 1920)
38 West Biddle Street, Baltimore 1, Md.

AUDIO ENGINEERING SCHOOL

A practical Audio Engineering course in Sound Fundamentals, E.I.M. and MAGNETIC Recording. Transmitters, Measurements, Monitoring and Mixing. Laboratories contain Transmission Sets, Oscillators, Harmonic Analyzer, Distortion Sets, Intermodulation Analyzer, and other equipment. Recording Studio simulating Broadcast, Motion Picture and Commercial Sound Recording. H. M. Tremaine, Pres. Director. Approved for Veterans and Foreign Wars.

HOLLYWOOD SOUND INSTITUTE, Inc.
1040-E North Kenmore Hollywood 27, Calif.



CORRESPONDENCE COURSES IN RADIO and ELECTRICAL ENGINEERING

ELECTRICAL ENGINEERING Get good grasp of electrical field. Prepare yourself at Low Cost, for secure future. Modern course. So simplified anyone can understand quickly.

RADIO ENGINEERING Extra fine course in radio. public address, photo-electric work. Trains you to be super-service man, real vacuum-tube technician. Servicemen needed badly. Diploma on completion. Many graduates earning big pay.

FREE Electronic Kit given to students enrolling by June 1. WRITE for free \$25 Either school catalog, student magazine, details of deferred payment plan, etc.

Lincoln Engineering School, Box 931-RE-3, Lincoln 8, Neb.

RADIO-ELECTRONICS for

vantage faced with a legitimate investigation as with an incompetent one. It is definitely the ethical man who feels that his profession has been represented in an incorrect light.

We do not wish to be critical of any action that has already been taken. The Pittsburgh investigation, whatever its faults, produced positive results. Our object is to attempt to persuade you of the reasonableness of our position at least to the extent that, to quote my letter of April 29, 1948, "if other Better Business Bureaus contact you in regard to tests of this type that you advise them to use genuine defective sets or to create genuine defects in the set rather than use 'gimmicks' which cannot give an exact idea of how the repairman would work on a genuinely defective set."

I regret that we have not up to the present been able to convince you of the importance of that one point, as I had hoped that the Pedro story would make the matter abundantly clear to any layman who, while having little knowledge of radio, might be better informed about motor cars and would have sufficient inductive ability to follow the analogy.

FRED SHUNAMAN
Managing Editor

RCA RADIO and TELEVISION
Thorough Training in All Technical Phases
APPROVED FOR VETERANS
DAYS—EVENINGS WEEKLY RATES
RCA GRADUATES ARE IN DEMAND
For Free Catalog Write Dept. RC-49
RCA INSTITUTES, Inc.
A Service of Radio Corporation of America
350 WEST 4TH STREET NEW YORK 14, N. Y.

ELECTRICAL TRAINING

Intensive 32 weeks' residence course in fundamentals of industrial electrical engineering, including radio, electronics. Prepares for technician, engineering aides. Approved for veteran training. 56th year. Enter Sept. 6, Jan. 9. Catalog.

BLISS ELECTRICAL SCHOOL
7545 TAKOMA AVENUE
WASHINGTON 12, D. C.

RADIO COURSES
● RADIO OPERATING ● CODE
● RADIO SERVICING ● ELECTRONICS
● F.M. TELEVISION
● REFRIGERATION SERVICING
Write for Catalog and Picture Brochure
Y.M.C.A. TRADE & TECHNICAL SCHOOLS
229 W. 66 St. (West of B'way) New York City

SHORT CUT **CODE SPEED**
Be an Expert
Learn to be a Telegrapher or Radio Operator. Thousands of men needed. Intensely interesting work—Good pay. Learn at home or wherever you are, quickly, easily, with the famous Candler Code Speed System. Qualify for amateur or commercial license. Book of particulars free.
CANDLER SYSTEM CO.
Dept. 3-E, Box 928 Denver 1, Colo.

RADIO ENGINEERING!
DEGREE IN 27 MONTHS
Complete Radio Engineering Course. Bachelor of Science Degree. Courses also in Civil, Electrical, Mechanical, Chemical, Aeronautical Engineering; Business Administration, Accounting, Secretarial Science. Graduates successful. 66th year. Enter Jan., March, June, Sept. Write for catalog.

TRI-STATE COLLEGE 2459 College Ave. ANGOLA INDIANA

MAY, 1949

LICENSING TECHNICIANS

Dear Editor:

I am glad to see that Mr. Joseph Amyd was interested enough in licensing (even though opposed to it) to state his views in the January issue. Among other things he says, "Licensing of other trades and professions has not eliminated these evils—there are still worthless and gyp doctors, lawyers, and so on."

There are unscrupulous and incompetent people in other businesses and professions. But how many more would there be if there were no licenses? At present anyone can call himself a technician and set up shop. If he is dishonest or ignorant, nothing can be done about it; but if he had a license, it could be revoked and he would go out of business.

My experience has been that mechanics, carpenters, and painters are on the average pretty straightforward businessmen. My experience with radio technicians has been that many are incompetent and dishonest.

If we can have licensed electricians, we can have licensed radio technicians.

WILLARD MOODY,
New York, N. Y.

STATIONS NOT OFF CHANNEL

Dear Editor:

In "European Report" in the January issue of RADIO ELECTRONICS there appeared this statement: "The report on frequency measurements during a recent month, for instance, shows that though 181 European stations deviated by less than 5 cycles from their allotted frequencies, there were 84 whose frequency wanderings exceeded 25 kilocycles! In the first class there were 17 French stations and in the second 11."

In the interests of truth as well as the honor of European broadcasting, I must point out that this is a grave error. It is possible that someone accidentally wrote "25 kilocycles" instead of "25 cycles." Our organization possesses a checking center in Brussels for measuring the frequencies of European broadcasting stations. Out of the 400 stations here, not over 20 deviate more than 100 cycles and these 20 are very-low-power transmitters reconstructed after the war as makeshifts. A very large proportion of the stations satisfy the conditions laid down at Atlantic City. Finally, we have never come across a single case of deviation of as much as 500 cycles. There is no French station which deviates more than 50 cycles and most have a stability better than 5 cycles.

We agree that there should be something like a European FCC—allowing for certain differences in the European situation from that in the U.S. It seems to me, however, that there are much more exact and substantial arguments to back this up than the frequency instability mentioned in your article.

H. ANGLÉS D'AURIAC,
International Broadcasting
Organization,
Brussels, Belgium

Some Prefer a Portable → 
Others Prefer a Standard ← 

But ALL Prefer
TWIN-TRAX*
"The Tape Recorder
the Engineers are Buying"

When it comes to high fidelity sound equipment, it's the specifications that count with engineers. And that's why they're buying Twin-Trax—the popular-priced tape recorder with professional specifications. Extended frequency response, wide dynamic range, low hum level, easy operation, trouble-free performance! And two tracks means twice the playing time on standard tape reels, with tape costs cut in half—a saving you don't have to be an engineer to appreciate.

Write today for technical literature and professional factory discounts.

*Trademark

AMPLIFIER CORP. OF AMERICA
398-10 Broadway New York 13, N. Y.

WAR SURPLUS BARGAINS
GIGANTIC MAIL SALE!
● ELECTRONICS ● RADIO
● ELECTRICAL APPARATUS
Sale ends midnight June 1st
Amazing values. Opportunity for home experimenters, laboratories, schools, etc., to get fine new, or new condition guaranteed equipment at fraction of original cost. We pay freight or postage. Typical items are listed below.

	Sale Price
● 3000-watt, 115-volt, 60-c Power Plants	\$299.50
● Wheatstone Bridges (0 to 11, 110 ohms.)	59.50
● Weston Air Port Photo-Light Control Units	29.90
● Weston Model 689-1F Industrial Ohm-meter and case	12.90
● W.E. Desk or Wall C.B. Telephones and ringer (complete)	4.99
● RCA (5", 3" and 2") Cathode Ray Tubes	3.55
● RCA Light, burglar alarm kit. Consists of rectifier, photo cell, thyatron, relay, sockets, etc.	4.49
● Drill press 31" polishing—grinding shaft and stone	1.29
● Burglar Alarm Units—Protect home and business	6.99
● High Pressure Steel Bottles (1800 lb.)	5.69
● Chromalux Heating Elements (24"—800-W)	2.19
● Selsyn Motors—Cost Gov't. \$90—110 V —60-C. Pair	4.99
● DeLuxe, Outstanding Electrical-Radio Home Lab Kit—80 pieces	6.77
● Carbon Pile Regulator. Dozens of uses	.99
● Miniature Multi-Station Telephone. Fine for office-residence inter-comm. Secret Line. A four star value. Pair	7.89

Order from ad or send card for bargain laboratory, experimenter and amateur catalog. Satisfaction guaranteed. Our reference—National Bank of Commerce.

LECO ENGINEERING CO.
BOX 908 RE-6 LINCOLN, NEBRASKA

WE ARE



Looking for **TUBES!** What have you got?

Yes, we are looking for your excess or obsolete tubes. Dig them up TODAY and convert them into ready CASH NOW... no quantity too large or too small... we need them all.

Send your list to:

MOHAWK ELECTRONICS CO.
160-C GREENWICH ST., NEW YORK 6, N. Y.

>> TUBES <<

FACTORY SEALED CARTONS
YOUR ASSORTMENT 25 FOR \$9.25
50 FOR \$18.00 100 FOR \$35.00

1RS	3S4	12SA7GT	35W4
1S5	3V4	12SK7GT	35Z5GT
1T4	12AT6	12SQ7GT	50B5
1U4	12BA6	12SJ7GT	50L6GT
3Q4	12BE6	35B5	117Z3

39c Each

ASSORTED BULK PACKED—25 for \$8.75
50 FOR \$17.00 100 FOR \$33.00

The following tubes at

6AG5	6AL5	49c	6F8G	6T8
6AK5	6AU6	each	6SN7GT	12AU7
				19T8

MANY OTHER TUBE TYPES AVAILABLE. SEND FOR FREE TUBE LIST.
Complete stock of replacement parts available for the RCA 630TS TV Receiver.
Send for our parts bargain list.
HALLMARK ELECTRONIC CORPORATION
594 Communipaw Ave.
Jersey City 4, New Jersey BRgen 4-6365

BETTER TV PICTURES
with Federated WAVE TRAP

Reduces interference, stabilizes picture. Really works! Easily connects to antenna terminals on TV set.

\$1.95 Only

FEDERATED PURCHASER, Inc., 80 Park Place, N. Y. C.
Allentown Store: 1113 Hamilton St., Allentown, Pa.

TELEVISION SCREEN VIEWING FILTERS

Make television far more enjoyable. You can make your own filters at very low cost. Different colors, all very easy and inexpensive to make. Send 25 cents for complete instructions. Instructions do not include material.

ELECTRONIC DEVICES CO.
P.O. Box 1016, Morgantown, W. Va.

CLARKSTAN PHONO NEEDLE GAUGE

Essential for Micro Groove & standard equipment. Accurate to one gram—has both gram and ounce scales for proper weight adjustment of all 100% tone arms. Net price \$1.50.

SEE YOUR JOBBER TODAY.
CLARKSTAN CORP. 11927 West Pico Blvd. Los Angeles 34, Calif.

UNIVERSAL SAVES U 50%

UNIVERSAL TROUBLE SHOOTER— Locates every service trouble. Does everything and guaranteed to do everything we say it will do. Aligns pointer. Locates dead spots, weak spots, defective parts. Checks gain. All parts including case, test lead, plug, 4 1/2" x 3" x 1/2". Ship. net \$3.95

INDUCTANCE TUNER for TELEVISION & FM front end 2 gang, individually isolated coils, 17 turns silver wire on a ceramic form, per gang. Fully shielded. Will cover FM and both Television bands. With circuit diagram. Ship. net \$4.25 ea

PHONO OSCILLATOR 2 TUBE KIT If you know value this is it. Orders come from Maine to Miami, Sandy Hook to San Francisco. All gain with microphone Jack and all parts including tubes. Ship. net \$2.95 ea

25 WATT P.P. 6L6 Hi Gain AMPLIFIER KIT A wonderful buy! Make up an amplifier worth \$10 to you. Powerful enough for auditoriums seating 1500 people. Separately controlled Mike & Phono inputs. All parts, incl. dilted chassis, hard ware, solder, wire, wall dia. Kit. net \$11.95 ea

PRICES NET F.O.B. OUR PLANT. Write for FREE data circuits designed by ROBT. G. HERZOG.

Universal general corp
365 J CANAL ST. N. Y. 13, Walker 5-9642

STILL THE LEADER!

The famous ACA-100 Amplifier — a self-balancing, drift-correcting, direct-coupled amplifier — the most satisfying musical amplifier ever designed. Based on early Loftin-White circuits, perfected by A. C. Shaney in 1936, and now brought to a standard of quality far above that of any corresponding amplifier. Exclusive features include:

- Push-Pull Triode Expander.
- Non frequency-discriminating noise suppressor.
- Push-pull hi and lo freq. variable equalizers.

If you are satisfied with nothing less than the best, write today for free technical literature.

Special models for all magnetic cartridges.

AMPLIFIER CORP. OF AMERICA
398-10 Broadway New York 13, N. Y.

ADVERTISING INDEX MAY 1949

Adson Radio & Electronics Company	97
Allied Radio Corporation	57
Alproco, Inc.	79
Alvaradio	91
American Phenolic Corp.	63
American Sales Company	88
American Television & Radio Company	11
Amperite Company	93
Amplifier Corporation of America	84, 95, 96
Arrow Sales, Inc.	66
Bell Telephone Laboratories, Inc.	Inside Back Cover
Bradshaw Instruments Company	92
Brooks Radio Distributing Corp.	86
Buffalo Radio Supply	8
Capital Radio Engineering Institute	7
Certified Television Laboratories	84
Cinex, Inc.	91
Clarkston Corporation	96
Cleveland Institute of Radio Electronics	18
Columbia Electronics	88
Commercial Radio	84
Communications Equipment Company	89
Coyne Electrical School	91
DeForest's Training, Inc.	9
Electronic Devices Company	96
Electronic Measurements Co.	92
Electro Products Laboratories	84
Electro-Voice Manufacturing Co.	71
Espey Manufacturing Company, Inc.	81
Fair Radio Sales	77
Federated Purchaser	96
Federal Telephone & Telegraph Co.	87
Franklin-Ellis Co.	87
G & G Radio Parts Service	73
General Electronic Distributing Company	67
Green Radio Distributors	74
Greylock Electronic Supply Company	81
Hallmark Electronics	96
Heath Company	12, 13, 14, 15
Hudson Specialties Company	90
Instructograph Company	81
International Resistance Company	85
Inventor's Association	78
JFD Manufacturing Company	16
The JRI Trainers	92
Kwikheat Manufacturing Company	91
Lafayette-Concord	97
James B. Lansing Sound, Inc.	4
Leco Engineering	95
Leatone Radio Corporation	89
Liquid Lens Co.	72
McGee Radio Company	6
Mid-America Company	82
Midway Company	91
Midwest Radio Corp.	80
Miles Reproducer	91
Mohawk Electronics Company	96
Murray Hill Books, Inc.	70
National Radio Institute	3
National Schools	5
Newark Electric Company	90
Offenbach & Reimus Company	86
Ohmite Manufacturing Company	69
Opad-Green Company	91
Opportunity Adlets	83
Phadick Sales Corporation	80
Precision Apparatus Company	85
Progressive Electronics Company	72

RADIO SCHOOL DIRECTORY (Pages 94-95)

American Radio Institute	
Baltimore Technical Institute	
Bliss Electrical School	
Candler System Company	
Commercial Radio Institute	
Hollywood Sound Institute, Inc.	
Lincoln Engineering School	
Milwaukee School of Engineering	
RCA Institutes	
Radio Television Institute	
Tri-State College	
Volparaiso Technical Institute	
YMCA Trade & Technical Schools	
R & M Radio Company	17
Radio Apparatus Company	84
Radionic Equipment Company	92
Radio City Products Co., Inc.	63
Radio Corporation of America	
Radio Mail Orders	Inside Front Cover, 83
Radio Publications	78
Radio Supply & Engineering Company	80
The Rose Company	86
Servelux	90
Senco Radio, Inc.	76
Simpson Electric Company	10, 88
Spartan School of Aeronautics	93
Superior Instruments	77
Sylvania Electric Products	59
Technical Appliance Co.	78
Technifax	76
Television Assembly Co.	Back Cover
Transvision	64, 65
United Radio Distributors	82
Universal General Corporation	96
United Surplus Materials	75
Wells Sales, Inc.	98

RADIO ENGINEERING, by E. K. Sandeman. Published by John Wiley & Sons, Inc., New York. 5½ x 8½ inches, 775 pages. Price \$6.50.

The author, a former BBC engineer, describes his own book beautifully in the following, taken from the introduction: "The writer has an infallible method of dealing with all mathematical descriptions. He glances at the type of mathematics involved, and if it is of a type that he can understand, there is evidently no point in reading it. He therefore looks at the conclusions reached to see if they are presented in a useful form. If they are not, the treatise is not very much use anyway! If, on the other hand, the mathematical argument is incomprehensible, there is also no point in reading it. But provided the problem is clearly formulated and the conclusions are clearly stated in explicit form, they may still be of full value to the practical man if he is capable of substituting in a simple formula."

Mr. Sandeman has taken his own admonition deeply to heart. A knowledge of garden-variety algebra and logarithms will carry any reader through the book, even though the pages are sprinkled very liberally with formulae. The point is that each formula is solidly useful for solving one of the intensely practical problems that working radiomen run up against. Wherever there is a chance of obscurity, a sample problem is cited and solved before the reader's eyes.

And yet this is an engineering book. It gives the basic facts of electronic life—and in detail. It is thoroughly useful to designers and equally helpful to those who must adjust and service anything from a home receiver to a high-power transmitter.

Many engineering books present theory alone, leaving the reader to correlate this with practice as best he can. Mr. Sandeman has presented all the theory—but he is apparently aware that electronic apparatus exists "in the flesh" as well as on paper!—*R.H.D.*

ATOMIC ENERGY, by Karl K. Darrow. Published by John Wiley & Sons, Inc., New York. 5½ x 8½ inches, 80 pages. Price \$2.00.

Dr. Darrow, a noted physicist, has assembled this book from four lectures he gave at Northwestern University in 1947. As a consequence, the style is conversational; with the author's facility for creating mental pictures and his logical, from-the-ground-up approach, this is one of the few books on nucleonics which need not be "waded" through. In fact, it's hard to put down.

The lecturer assumes that the audience has practically no knowledge of even the electron theory. Yet, slowly, surely, and inevitably, he guides his hearers through the complexities leading to the release of nuclear energy. All the basic qualitative (and even a little quantitative) information is given, spiced with history and background.

The book will qualify no one for a degree in nuclear physics, but 76 pages

after he begins, the reader will find himself in possession of a larger number of well integrated atomic facts than he would ever have thought possible.

—*R.H.D.*

PRACTICAL TELEVISION SERVICING, by J. R. Johnson and J. H. Newitt. Published by Murray Hill Books, Inc., New York. 6 x 9 inches, 334 pages. Price \$4.00.

After opening the book with a basic discussion of television fundamentals, the authors proceed to discuss the television receiver by breaking it down into its r.f., i.f., detector, sweep, video, power supply, and C-R tube circuits, discussing each section in great detail. By so doing, they cover each section of the receiver along with its particular servicing problems without relying on previous discussions or those to come later in the book.

In their discussion of antennas and wave propagation they describe the various types of TV antennas, their characteristics, and the types of transmission lines that may be used under different conditions with advantages and drawbacks of each type.

The section on receiver installation alone is well worth the price of the book to the average service technician or installation man. The authors go into considerable detail on the problems of antenna placement and mounting; supplementing their material with photographs and drawings. One chapter is devoted to the requirements and operation of test equipment for TV receiver servicing. This section ties in nicely with the following discussions on wiring techniques, trouble-shooting, case histories, and common defects which are often found by the technician in TV receivers.

The book concludes with an appendix of tables providing such information as frequencies of TV channels, intermediate frequencies used in many commercial sets, oscillator frequencies for given i.f. channels, characteristics of common transmission lines, and a ten-page glossary of television terms.



"Gosh! My Wife!!"

Suggested by Jack C. Thurston, El Centro, Calif.

IN LINE WITH OUR POLICY OF RECOMMENDING THE MOST FOR THE LEAST TO THE AMATEUR, SERVICEMAN AND HOBBYIST, WE ARE PRESENTING THE FOLLOWING ITEMS

ECO VACUUM TUBE VOLTMETER KIT

Model 221K • **\$23.95**

Complete Kit THE MOST USEFUL TOOL ON YOUR RADIO BENCH! D.C. and A.C. ranges 0-5, 10, 100, 500, and 1000 volts. Ohmmeter ranges from 2 ohm to 1,000 megohms in steps of Rx1, Rx10, Rx1000, Rx10,000 and Rx1 megohm. 10 scale from -20 to 5500 in 5 ranges. D.C. input resistance is 25 megohms. A.C. input impedance is over 1½ megohms. A.C. rectifier for greater accuracy and wider frequency range to 30 Kc. Large, rugged 4½" meter with all A.C. and D.C. readings on one scale. Complete with tubes and test leads.



COMPLETELY FACTORY WIRED.....\$49.95

OSCILLOSCOPE KIT

Model 100 K indispensable for AM, FM, and TELEVISION. Horizontal sweep circuit 15 to 30,000 cycles. All controls on front panel. Linear sweep with 881 gas triode. Graph screen for measuring peak to peak voltage. Frequency response of horizontal and vertical amplifiers from 50 cycles to 50 Kc. Input impedance 1 megohm and 50 ohms. Etched panel for long life. Tube complement: 2-6X4, 2-5Y3, 1-881, 1-6BP1. Provision for external synchronization, test voltage and intensity modulation. Deflection sensitivity: 30 volts per inch full gain. Detailed instructions and pictorial diagrams included. **NOTHING ELSE TO BUY!** Size 8½" W x 13" H x 17" D. Ship. wt. 10 lbs.



COMPLETELY FACTORY WIRED.....\$69.95

20% Deposit required with C.O.D. orders.

ADSON
RADIO & ELECTRONICS CO.
221 Fulton Street New York 7, N. Y.



YOU'LL SAVE MANY DOLLARS WITH THIS BIG 180 PAGE FREE CATALOG

TELEVISION, ELECTRONIC PARTS, HIGH FIDELITY RADIO, HAM GEAR, PUBLIC ADDRESS EQUIPMENT, PARTS AND WORKSHOP TOOLS

A penny postcard will bring you the 1949 Lafayette-Concord catalog. It's a bargain guide that means big savings to you. There are pages and pages of the finest equipment at amazing low prices. Use it to order everything you need, and pocket the difference. Helps you save both time and money. You'll like shopping from this mammoth book of bargains.

Write for your copy today. It's free!

LAFAYETTE-CONCORD World's largest radio supply organization

LAFAYETTE-CONCORD, Dept. JE-9
100 Sixth Avenue, New York 13
901 West Jackson Blvd., Chicago 7
265 Peachtree Street, Atlanta 3

FREE!

Please rush free catalog No. 89

Name.....
Address.....
City..... Zone..... State.....

RUSH THIS COUPON FOR FREE CATALOG

TRANSMITTING

Mica

CONDENSERS

PARTS SHOW VISITORS:

Be sure to visit our tremendous showrooms at 320 N. LaSalle St. Thousands of electronic components conveniently displayed.

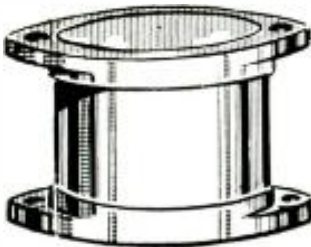

STYLE "AA"

SPECIAL LOW PRICES FOR IMMEDIATE SALE AND DELIVERY

We have literally hundreds of thousands of these top quality standard type transmitting mica condensers in stock for immediate delivery at a fraction of their original cost. Every condenser is brand new and carries the name of a fine nationally known manufacturer.

Despite the unusually low prices, these mica condensers, like all Wells Components, are fully guaranteed. Be sure to order sufficient quantities for your requirements.



STYLE "A"

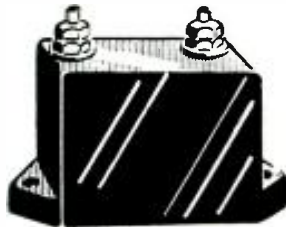

STYLE "B"



STYLE "C"



STYLE "D"

Cap. Mfd.	Wrkg. Volts	Mfr. Leg.	Price Each:	Cap. Mfd.	Wrkg. Volts	Mfr. Leg.	Price Each:	Cap. Mfd.	Wrkg. Volts	Mfr. Leg.	Price Each:
STYLE "AA" CONDENSERS				STYLE "C" CONDENSERS				STYLE "D" CONDENSERS			
.02	3000	2	\$4.50	.024	1500	3	1.60	.02	600	7	.35
.04	1000	2,7	3.50	.033	1500	3,7	1.60	.02	1200	7	.45
STYLE "A" CONDENSERS				STYLE "C" CONDENSERS				STYLE "D" CONDENSERS			
25mmfd	10000	8	\$1.65	.056	1000	3,7	1.70	.022	1200	7	.45
STYLE "B" CONDENSERS				STYLE "C" CONDENSERS				STYLE "D" CONDENSERS			
.00003	2000	2	\$0.70	.06	1000	8	1.70	.025	600	8	.35
.000047	3000	1	.80	.1	1000	8	1.75	.03	600	6	.35
.00005	3000	2,9	.75	.000005	2500	2	\$0.40	.03	1200	2,8	.50
.00007	1140	6	.70	.00005	600	7,8	.30	.033	600	7	.35
.00009	3000	2,7,9	.75	.0001	600	2,7	.25	.04	600	7,8	.35
.000091	3000	7	.80	.0001	1200	7	.35	.073	250	8	.40
.0001	3000	2,7,9	.80	.0001	2500	4,7,8	.40	.00004	600	7	\$0.20
.000107	3500	1	.85	.0002	600	2,7,9	.25	.00005	1200	1,7,9	.25
.00011	3000	8	.95	.0002	2500	7	.40	.00005	2500	2,8,9	.30
.00137	3000	2	.95	.0002	2500	7	.45	.0001	600	9	.20
.000175	1500	8	1.00	.0002	2500	7	.45	.0001	1200	7,8	.25
.0002	1430	6	1.00	.00025	2500	7,8	.45	.00015	2500	2,6	.35
.0002	3000	7,8	1.00	.0003	2500	7	.45	.00024	2500	6	.35
.0002	5000	1,8	1.05	.00039	2500	7	.50	.00025	1200	6,8	.25
.00025	5000	7	1.10	.0004	2500	2,7,9	.35	.00025	2500	6,8	.35
.0004	3000	2,7	.95	.0004	2500	2,7,9	.45	.0005	1200	7	.30
.0004	5000	2,7,8	1.10	.0004	3750	7	.85	.00051	2500	1	.35
.0004	6000	1	1.55	.001	600	2	.35	.0007	600	2	.25
.0005	2000	7	.95	.001	600	7	.35	.0007	600	2,8	.25
.0005	3000	3	1.00	.002	1200	2	.45	.001	1200	6,8,9	.35
.00051	3000	7	1.00	.002	1200	2	.45	.001	2500	6,8	.40
.00055	3000	7	1.10	.002	2500	1,2,8	.55	.0011	2500	8	.40
.0006	2500	7	1.05	.002	3500	8	.80	.002	600	1,2,9	.25
.0006	5000	8	1.15	.002	3500	8	.80	.002	1000	8	.30
.000625	3000	7	1.05	.0022	2500	7	.60	.002	1200	6,7,8	.35
.0007	3000	7	1.05	.003	600	8	.40	.002	1200	8	.30
.00075	2500	2	1.05	.0035	2500	7,9	.60	.002	1250	1	.35
.00075	5000	8,9	1.15	.0039	2500	2	.60	.002	2500	8	.40
.0008	3000	7	1.00	.004	2500	2,7	.60	.0022	1200	8,7	.30
.0008	5000	2,8	1.15	.0045	600	8	.40	.0022	2500	8	.40
.001	4500	2,9	1.25	.0046	500	9	.45	.0025	600	2	.25
.001	5000	7,8	1.30	.0047	2500	8	.65	.0025	1200	1	.35
.0011	5000	2,7	1.35	.005	600	2	.35	.0027	600	1	.25
.00125	2000	7	1.10	.005	1200	7,8	.45	.003	600	2	.25
.0014	5000	2	1.35	.005	2500	7,8	.60	.003	1200	6,7,8	.30
.0015	3000	7	1.10	.0051	1200	7	.45	.0033	1200	6	.30
.0024	3000	8	1.15	.0051	2500	7,8	.65	.004	1100	8	.35
.0025	2000	1,2,7	1.10	.0054	2500	8	.65	.004	1200	7,8	.35
.00275	2000	1,7	1.10	.006	600	7,9	.40	.004	2500	9	.45
.003	2000	7	1.20	.006	2500	7	.65	.0044	600	8	.25
.004	3000	2,8	1.50	.006	2500	7	.60	.0047	2500	6,8	.40
.005	2000	2	1.40	.0068	1200	7	.60	.005	600	2,6,7	.25
.005	5000	6,8	1.70	.007	600	8	.35	.005	600	1,2	.25
.006	2500	7	1.30	.0075	1200	2	.55	.006	600	2,7,8	.30
.006	3500	8	1.45	.009	600	9	.50	.01	600	2,7,8	.40
.0068	3000	8	1.40	.01	600	2,7,8	.40	.01	1200	6,7,8	.40
.008	3000	7,8	1.45	.01	1200	3,7,8	.45	.01	1250	1,6,9	.40
.01	2000	1,2,3	1.55	.01	2500	7,8	.60	.01	2500	2,8	.50
.01	1000	7	1.35	.0115	600	8	.40	.02	600	2,6,8	.25
.02	600	7	1.30	.013	1200	3	.55	.022	600	7	.25
.02	2000	2,8	1.60	.015	1200	7	.55	.025	1200	7	.35
				.015	2000	8	.60	.027	600	7	.25
				.015	2500	7,8	.60	.03	600	2,8	.25
				.0175	1200	2	.55	.05	600	7	.30

Manufacturers' Legend:

- 1—Aerovox; 2—Cornell Dubilier; 3—Faradon; 4—General Electric; 5—Illinois; 6—Mica-Mold;
- 7—Sangamo; 8—Solar; 9—Sprague

This is only a partial listing. Write or wire for information on types not shown and for receiving set micas and silver micas.

We advise distributors to order immediately from this ad. Our standard jobber arrangement applies.

Manufacturers and Distributors: Write for our complete Mica Condenser Listing No. 103A.



320 N. LA SALLE ST. DEPT. Y, CHICAGO 10 ILL.

THE EAR IS OUR CUSTOMER

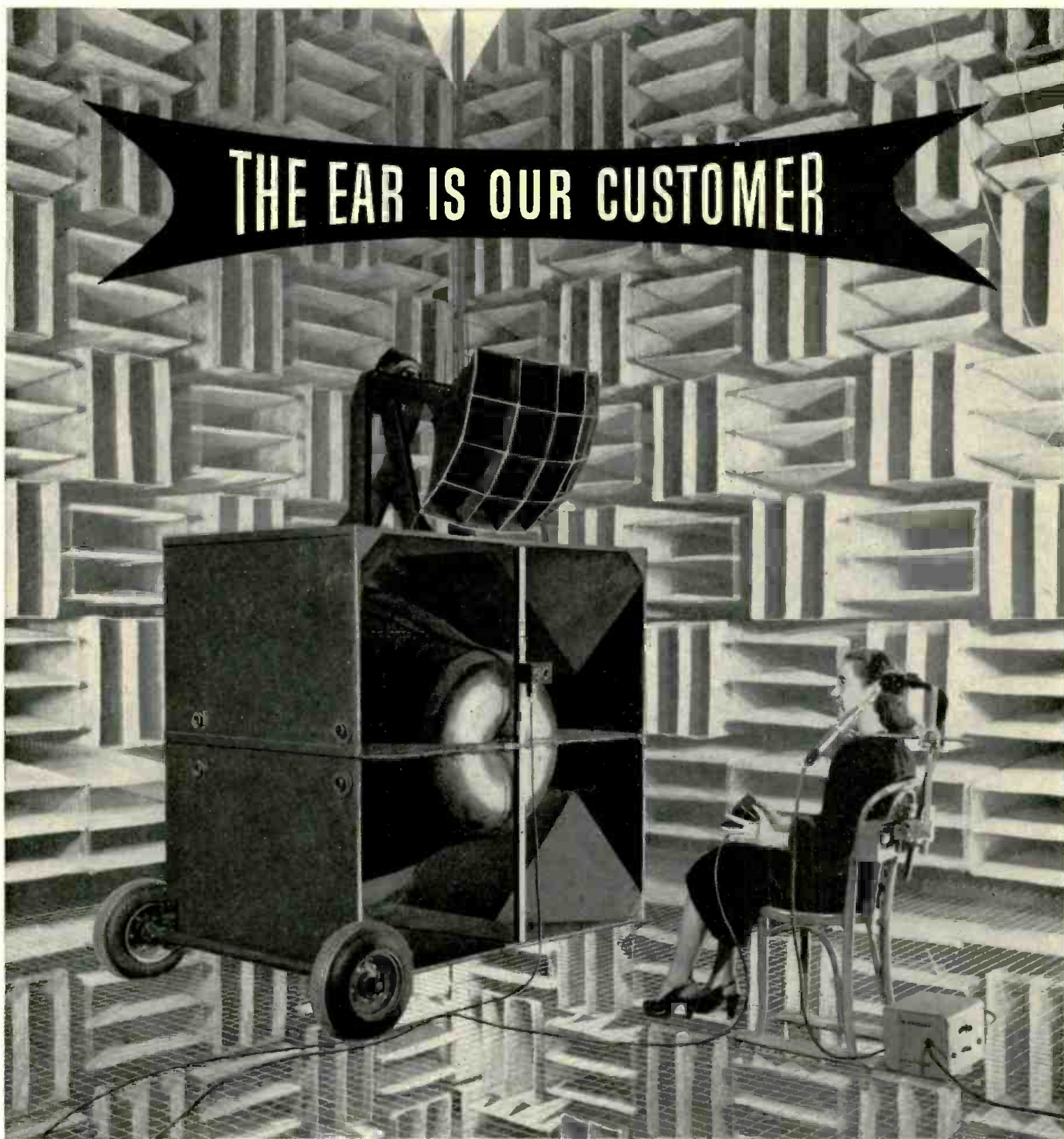

What happens when you hear? What happens *inside* your ear when sound waves come in from a telephone conversation?

Bell Telephone Laboratories scientists have developed special apparatus to help answer these questions, for the telephone system is designed to meet the ear's requirements for good listening.

In the test pictured above, the young lady sits before loudspeakers in a soundproofed room with a small hollow tube, reaching just inside the ear canal. Sounds differing slightly in frequency and intensity come from a loudspeaker. The subject seeks to tell one from another, recording her judgment electrically by pressing a switch.

Meanwhile, the same sound waves pass down the hollow tube to a condenser microphone, and a record is made of the exact sound intensities she identified. Results help reveal the sound levels you can hear clearly and without strain—the sounds your telephone must be designed to carry.

Scientists at Bell Telephone Laboratories make hundreds of tests in this manner. It's just one part of the work which goes on year after year at the Laboratories to help keep Bell System telephone service the finest on earth.

BELL TELEPHONE LABORATORIES

Exploring, and inventing, devising and perfecting, for continued improvements and economies in telephone service.



T.A.C. DOES IT *First* AGAIN!

"America's greatest Television Values per square inch of picture!"

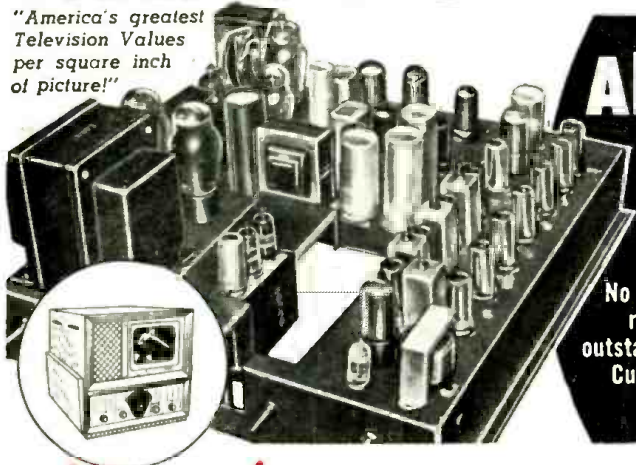

All Major Components Already Mounted on Chassis!

No technical knowledge required to build this outstanding, proven T.A.C. Custom-Built Television Receiver!

including Pre-wired "VIVideo" I. F. Strip and Pre-wired front end

Now! BUILD THE FINEST PROVEN CUSTOM-BUILT TELEVISION RECEIVER IN MUCH LESS TIME . . . WITH LESS EFFORT . . . FOR LESS MONEY!

EXCLUSIVE T. A. C. "VIVideo" FEATURE

Pre-wired, pre-tuned and tubed I.F. sound and video strip (patents pending). An exclusive T.A.C. feature developed by our own research. All in one chassis.

FREE

Complete comprehensive Service Data on the T.A.C. exclusive "VIVideo" 13-tube Picture and Sound I.F. Strip (Pat. Pend.). Contains all information needed to thoroughly understand and service this unique high-gain I.F. Strip which features 5 1/2 stages of Cathode-Coupled Grounded-Grid Video I.F. amplification. For high gain, sensitivity, stability, "VIVideo" can't be beat! Write for FREE booklet SB-1 or ask your local jobber for it. Booklet SB-1 also included with each T.A.C. Direct-View assembly.

NEW! SUPER-SIMPLIFIED INSTRUCTIONS! AND COMPLETE SERVICE DATA



The most explicit, easiest-to-follow, most elaborately detailed instructions in television-- that even a layman can follow. ONLY 13 TUBES REMAIN TO BE WIRED! ABSOLUTELY NOTHING TO MOUNT!

T.A.C. STANDARD MODELS

29 RCA tubes, plus RCA or DuMont C. R. Tube. Pre-wired "VIVideo" 13-tube Picture and Sound I.F. Strip with 5 1/2 stages of Picture Amplification. Pre-wired All-Channel Front End with Fine Tuning. RCA 5x7 Oval Heavy Duty PM Speaker. Delivered complete, with ALL MAJOR COMPONENTS MOUNTED, PLUS New Comprehensive SUPER-SIMPLIFIED DATA for Wiring and Servicing.

Model M101S—Complete (less C.R. Tube)	\$169.50	Dealer's Net*
Model F101S—Complete with 10" RCA C.R. Tube	203.50	Dealer's Net*
Model F121S—Complete with 12" DuMont C.R. Tube	231.25	Dealer's Net*
Model F151S—Complete with 15" DuMont C.R. Tube	314.50	Dealer's Net*

T.A.C. CHAMPION MODELS

Identical extra-value features as above except Standard Tuner replaced by DuMont Inputuner for Continuous Tuning of ALL FM RADIO AND TV CHANNELS.

Model M101C—Complete (less C.R. Tube)	\$209.50	Dealer's Net*
Model F101C—Complete with 10" RCA C.R. Tube	243.75	Dealer's Net*
Model F121C—Complete with 12" DuMont C.R. Tube	271.40	Dealer's Net*
Model F151C—Complete with 15" DuMont C.R. Tube	357.35	Dealer's Net*
Model F201C—Complete with 20" DuMont C.R. Tube	566.75	Dealer's Net*

ALL T.A.C. 15" and 20" Assemblies contain 30 RCA tubes, plus DuMont C.R. tube, RCA 12" Heavy Duty PM Speaker, and all features mentioned above PLUS Pre-wired 14KV High Voltage Doubler Power Supply.

CABINETS AND STANDS IN BLOND AND WALNUT AVAILABLE AT REASONABLE PRICES. WRITE FOR LITERATURE.

GUARANTEE

All components are of the finest quality and are fully guaranteed under the Standard RMA Guarantee. All TAC Assemblies are guaranteed to operate when assembled according to directions.

MODEL P-520 . . . 520 Sq. In. SCREEN PROJECTION TELEVISION ASSEMBLY

- Bausch & Lomb F; 1.9 Lens • Eastman Kodak Screen • DuMont Inputuner • 37 R.C.A. Tubes • Pre-Wired & Pre-Tuned Picture I.F. & Sound I.F. • Pre-Wired 30 K.V. Tripler Fly Back Power Supply • Automatic Gain Control • Aluminum Coated Top Mirror • Metal Rock • Specially Designed Hood and Picture Frame Supplied • 5TP4 Projection Tube • 12" R.C.A. High Fidelity Speaker • Two Low Voltage Power Supplies.

MODEL P-520	Dealer's net	\$769.50*
MODEL P-520W	Dealer's net	\$895.00*

The above unit completely wired and ready to install.

Front and rear panels optional at additional cost.

Complete Instruction and Service Manual compiled by John F. Rider Laboratories in collaboration with T.A.C. engineers, included with each P-520. This manual also separately available at \$2.50 each, dealer's net. Ask your local jobber for it.

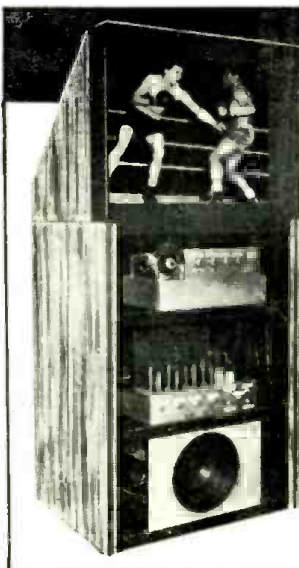

TELEVISION ASSEMBLY CO.

Subsidiary of
Snider Television Corp.

● Write for Catalog on our Complete Line of TV Replacement Components!

* PRICES 5% HIGHER WEST OF THE MISSISSIPPI

Prices subject to change without notice.

540 BUSHWICK AVE.
BROOKLYN 6, N. Y.

Distributed through NATIONAL PARTS DISTRIBUTORS
Write for the source nearest to you